

CITY OF CORAL GABLES, FLORIDA

RESOLUTION NO. 2018-22

A RESOLUTION ACCEPTING THE RECOMMENDATION OF THE PROCUREMENT OFFICER TO AWARD THE PLANNING SERVICES FOR ZONING CODE UPDATE CONTRACT TO DPZ PARTNERS, LLC D/B/A DPZ CODESIGN, THE TOP-RANKED PROPOSER, PURSUANT TO SECTION 2-763 OF THE PROCUREMENT CODE ENTITLED "CONTRACT AWARD" AND REQUEST FOR PROPOSALS (RFP) 2017.05.MS; AUTHORIZING THE CITY MANAGER TO NEGOTIATE A FINAL CONTRACT AMOUNT ACCEPTABLE TO THE CITY FOR THIS PROJECT (NOT TO EXCEED THE BUDGETED AVAILABLE FUNDS).

WHEREAS, on May 8, 2017, the Procurement Division of Finance formally advertised, issued, and distributed Planning Services for Zoning Code Update, RFP 2017.05.MS; and

WHEREAS, on May 17, 2017, a non-mandatory pre-proposal conference was held with five (5) prospective proposers in attendance of the seventy-one (71) prospective proposers who downloaded the RFP package from PublicPurchase, the City's web based e-Procurement service; and

WHEREAS, on June 7, 2017, five (5) proposals were received in response to the Planning Services for Zoning Code Update, RFP No. 2017.05.MS from: The Corradino Group, Inc., The Mellgren Planning Group, DPZ Partners, LLC d/b/a DPZ CoDesign, Plusurbia, LLC, and Zyscovich Architects; and

WHEREAS, on July 19, 2017, the Evaluation Committee convened to evaluate the five (5) responsive proposals and determined that DPZ Partners, LLC d/b/a DPZ CoDesign, is the top-ranked proposer; and

WHEREAS, the Evaluation Committee recommended that the City award and negotiate a contract with DPZ Partners, LLC d/b/a DPZ CoDesign; and

WHEREAS, the Procurement Officer recommends accepting the Evaluation Committee's recommendation to award the Planning Services for Zoning Code Update contract to DPZ Partners, LLC d/b/a DPZ CoDesign, subject to negotiations on a final contract amount and execution of a contract by City staff; and

WHEREAS, Section 2-585 of the Procurement Code authorizes the City Manager to delegate authority to the Procurement Officer to administer and make recommendations on City contracts;

NOW, THEREFORE, BE IT RESOLVED BY THE COMMISSION OF THE CITY OF CORAL GABLES:

SECTION 1. The foregoing “Whereas” clauses are hereby ratified and confirmed as being true and correct and are hereby made a specific part of this Resolution upon adoption hereof.

SECTION 2. That the City Commission accepts the recommendation of the Procurement Officer to award the Planning Services for Zoning Code Update contract to DPZ Partners, LLC d/b/a DPZ CoDesign, the top-ranked proposer, pursuant to Section 2-763 of the Procurement Code entitled “Contract Award” and Request for Proposals (RFP) 2017.05.MS; authorizing the City Manager to negotiate a final contract amount acceptable to the City for this project (not to exceed the budgeted available funds).

SECTION 3. That this Resolution shall become effective upon the date of its passage and adoption herein.

PASSED AND ADOPTED THIS TWENTY-THIRD DAY OF JANUARY, A.D., 2018
(Moved: Lago / Seconded: Keon)
(Yeas: Mena, Quesada, Keon, Lago, Valdes-Fauli_
(Unanimous: 5-0 Vote)
(Agenda Item: J-1)

APPROVED:



RAUL VALDES-FAULI
MAYOR

ATTEST:

WALTER J. FOEMAN
CITY CLERK

APPROVED AS TO FORM AND
LEGAL SUFFICIENCY:

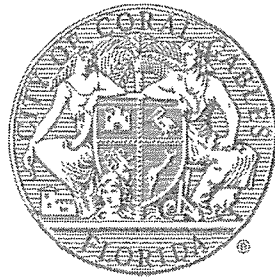
MIRIAM SOLER RAMOS
CITY ATTORNEY



REQUEST FOR PROPOSALS RFP 2017.05.MS

PLANNING SERVICES FOR ZONING CODE UPDATE

DPZ CoDESIGN
1023 SW 25TH AVENUE
MIAMI, FLORIDA 33135
TEL 305 644 1023

CONTACT: SENEN ANTONIO
SENEN@DPZ.COM

06 JUNE 2017

"Continue Coral Gables' vision and mission as a community that is attractive to live, work, play and visit.

"Provide quality design principles that serve to encourage and advance creativity in design, while preserving and promoting the City's historic Mediterranean character.

"Preserve residential properties to assure that future development will be in conformity with the foregoing distinctive character, with respect to type, intensity, design, appearance and is attainable for all persons.

"Provide the comprehensive plan foundation for the protection and enhancement of the City of Coral Gables' historic and cultural resources, including buildings, structures, sites, districts, objects, archaeological sites, and other landmarks.

"Promote the health, safety, and security of the City's residents and visitors, including in times of disasters and other emergencies.

"Provide high quality public facilities that meet and exceed the minimum level of service standards.

"Provide goals, objectives, and policies that preserve, improve, and promote responsible use and protect the City's natural and built environment."

- Select Vision Statements from the City of Coral Gables 2010 Comprehensive Plan

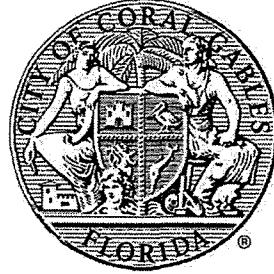

REQUEST FOR PROPOSALS RFP 2017.05.MS

PLANNING SERVICES FOR ZONING CODE UPDATE

DPZ CoDESIGN
1023 SW 25TH AVENUE
MIAMI, FLORIDA 33135
TEL 305 644 1023

CONTACT: SENEN ANTONIO
SENEN@DPZ.COM

06 JUNE 2017

I. TABLE OF CONTENTS

SECTION I: TITLE PAGE, TABLE OF CONTENTS, REQUIRED FORMS, AND MINIMUM REQUIREMENTS

Title Page

Page 1

Table of Contents

Page 2

Proposer's Acknowledgement Form

Page 3

Solicitation Submission Checklist

Page 4

Proposer's Affidavit and Schedules A Through I*
(*Schedule E is Omitted)

Page 6

Minimum Qualification Requirements

Page 17

SECTION II: EXPERIENCE AND KEY PERSONNEL

Proposer's Company Background and History

Page 19

Key Personnel

Page 28

SECTION III: PROJECT UNDERSTANDING, PROPOSED APPROACH, AND METHODOLOGY

Project Understanding, Proposed Approach, and Methodology

Page 47

Recent, Current, and Projected Workload

Page 54

SECTION IV: PAST PERFORMANCE AND REFERENCES

References

Page 55

Proposer's Previous Contracts with the City of Coral Gables

Page 59

Public Sector Clients That Have Discontinued Use of Proposer's Services

Page 60

SECTION V: PRICE PROPOSAL

Page 61

CITY OF CORAL GABLES, FL

2800 SW 72nd Avenue, Miami, FL 33155
 Finance Department / Procurement Division
 Tel: 305-460-5102 / Fax: 305-261-1601

PROPOSER'S ACKNOWLEDGEMENT

<p>RFP Title: PLANNING SERVICES FOR ZONING CODE UPDATE RFP No. 2017.05.MS</p> <p>A cone of silence is in effect with respect to this RFP. The Cone of Silence prohibits certain communication between potential vendors and the City. For further information, please refer to the City Code Section 2-1059 of the City of Coral Gables Procurement Code.</p>	<p>Sealed response submittals must be received prior to 1:00 p.m., Wednesday, June 7, 2017, by the Procurement Office, located at 2800 S.W. 72nd Avenue, Miami, FL 33155; and are to remain valid for 120 calendar days. Submittals received after the specified date and time will be returned unopened.</p> <p>Contact: Maritza Suarez, CPPB Title: Procurement Specialist Telephone: 305-441-5745 Facsimile: 305-261-1601 Email: msuarez2@coralgables.com / contracts@coralgables.com</p>
--	---

Proposer Name: DPZ PARTNERS, LLC dba DPZ CoDESIGN	FEIN or SS Number: 20-2563570
Complete Mailing Address: 1023 SW 25TH AVENUE, MIAMI, FLORIDA 33135	Telephone No.: 305 644 1023
	Cellular No.: 786 246 148
Indicate type of organization below: Corporation: <input type="checkbox"/> Partnership: <input type="checkbox"/> Individual: <input type="checkbox"/> Other: <input checked="" type="checkbox"/>	Fax No.: 305 644 1021
Bid Bond / Security Bond (if applicable) <u> </u> - <u> </u> %	Email: senen@dpz.com

ATTENTION: THIS FORM ALONG WITH ALL REQUIRED RFP FORMS MUST BE COMPLETED, SIGNED (PREFERABLY IN BLUE INK), AND SUBMITTED WITH THE RESPONSE PRIOR TO THE SUBMITTAL DEADLINE. FAILURE TO DO SO MAY DEEM PROPOSER NON-RESPONSIVE.

THE PROPOSER CERTIFIES THAT THIS SUBMITTAL IS BASED UPON ALL CONDITIONS AS LISTED IN THE RFP DOCUMENTS AND THAT THE PROPOSER HAS MADE NO CHANGES IN THE RFP DOCUMENT AS RECEIVED. THE PROPOSER FURTHER AGREES IF THE RFP IS ACCEPTED, THE PROPOSER WILL EXECUTE AN APPROPRIATE AGREEMENT FOR THE PURPOSE OF ESTABLISHING A FORMAL CONTRACTUAL RELATIONSHIP BETWEEN THE PROPOSER AND THE CITY OF CORAL GABLES FOR THE PERFORMANCE OF ALL REQUIREMENTS TO WHICH THIS RFP PERTAINS. FURTHER, BY SIGNING BELOW PREFERABLY IN **BLUE INK**, ALL RFP PAGES ARE ACKNOWLEDGED AND ACCEPTED AS WELL AS ANY SPECIAL INSTRUCTION SHEET(S) IF APPLICABLE. THE UNDERSIGNED HEREBY DECLARES (OR CERTIFIES) ACKNOWLEDGEMENT OF THESE REQUIREMENTS AND THAT HE/SHE IS AUTHORIZED TO BIND PERFORMANCE OF THIS RFP FOR THE ABOVE PROPOSER.

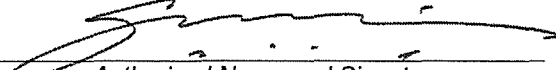
 _____ Authorized Name and Signature	PARTNER _____ Title	JUNE 6, 2017 _____ Date
---	---------------------------	-------------------------------

SOLICITATION SUBMISSION CHECKLIST

Request for Proposals (RFP) No. 2017.05.MS

COMPANY NAME: (Please Print): <u>DPZ PARTNERS, LLC dba DPZ CoDESIGN</u>
Phone: <u>305 644 1023</u> Email: <u>senen@dpz.com</u>

Please provide the **PAGE NUMBER** in the blanks provided as to where compliance information is located in your Submittal for each of the required submittal items listed below:

SUBMITTAL - SECTION I: TITLE PAGE, TABLE OF CONTENTS, REQUIRED FORMS, AND MINIMUM REQUIREMENTS.

- 1) **Title Page:** Show the RFP number and title, the name of your firm, address, telephone number, name of contact person, e-mail address, and date. 1
- 2) Provide a **Table of Contents** in accordance with and in the same order as the respective "Sections" listed below. Clearly identify the material by section and page number. 3
- 3) Fill out, sign, and submit the **Proposer's Acknowledgement Form**. 4
- 4) Fill out and submit this **Solicitation Submission Checklist**. 5 - 6
- 5) Fill out, sign, notarize, and submit the **Proposer's Affidavit and Schedules A through I**. 7 - 17
- 6) **Minimum Qualification Requirements:** submit detailed verifiable information affirmatively documenting compliance with the Minimum Qualifications Requirements shown in Section 3. 18

SUBMITTAL - SECTION II: EXPERIENCE AND KEY PERSONNEL

(i) For Proposer:

- 1) Provide a complete company background and history, including, but not limited to, the number of years in business, credentials, copy of applicable licenses/certifications, capabilities and capacity to effectively meet the City's needs, number of employees, relevant experience and proven track record, during the past five (5) years, in providing similar scope of services as identified in this solicitation to public sector agencies, particularly to municipal/local governments. 19 - 27

(ii) For Key Personnel:

- 1) Provide a summary of the qualifications, copy of applicable licenses/certifications, and experience of all proposed key personnel that will perform supervisory, management or oversight responsibilities. Include resumes (listing experience, education, licenses/certifications) for your proposed key personnel and specify the role and responsibilities of each team member in providing the services outlined in the RFP. 28 - 46

SUBMITTAL - SECTION III: PROJECT UNDERSTANDING, PROPOSED APPROACH, AND METHODOLOGY

- 1) Describe in detail, your approach and methodology to perform the services solicited herein. Include detailed information, as applicable, which addresses, but need not be limited to: understanding of the RFP scope and requirements, implementation plan, strategies for assuring assigned work is completed on time and communication with City staff. Indicate how the Proposer intends to positively and innovatively work with the City in providing the services outlined in this RFP. 47 - 53

I. SOLICITATION SUBMISSION CHECKLIST

- 2) Provide recent, current and projected workload for the Proposer and key personnel assigned to the City's account. Explain how this potential contract will fit into the Proposer's workload. 54

SUBMITTAL – SECTION IV: PAST PERFORMANCE AND REFERENCES

- 1) Provide a minimum of three (3) references from public sector agencies, particularly municipal/local government, for which Proposer has performed similar scope of services in the past five (5) years. Please include: (1) client name, (2) address, (3) contact name, (4) contact telephone number, (5) contact email address, (6) term of contract (start and end date), (7) contract amount, (8) services provided. **DO NOT include work/services performed for the City of Coral Gables or City employees as reference.** 55 - 58
- 2) If the City has previously awarded the Proposer a contract, identify the details of that award as well as the department and contract administrator for the contract. 59
- 3) Provide a list with contact information of public sector clients, if any, that have discontinued use of Proposer's services within the past two (2) years and indicate the reasons for the same. The City reserves the right to contact any reference as part of the evaluation process. 60

SUBMITTAL – SECTION V: PRICE PROPOSAL

- 1) Provide pricing utilizing the Price Proposal form under this section. 61 - 63

-- NOTICE --

BEFORE SUBMITTING YOUR RESPONSE, MAKE SURE YOU:

1. Carefully read and have a clear understanding of the RFP, including the Scope of Services and enclosed Professional Services Agreement (*draft*).
2. Carefully follow the "Submission Requirements" outlined in Section 6 of the RFP.
3. Prepare and submit ONE (1) ORIGINAL RESPONSE and SIX (6) PHOTOCOPIES with ONE (1) digital copy on a CD or flash drive.
4. Clearly mark the following on the outside of your submittal package: RFP Number, RFP Title, Proposer's Name and Return Address, Submittal Deadline.
5. Make sure your Response is submitted prior to the submittal deadline. **Late responses will not be accepted.**

FAILURE TO SUBMIT THIS CHECKLIST AND THE REQUESTED DOCUMENTATION MAY RENDER YOUR RESPONSE SUBMITTAL NON-RESPONSIVE AND CONSTITUTE GROUNDS FOR REJECTION. THIS PAGE IS TO BE RETURNED WITH YOUR RESPONSE PACKAGE.

I. PROPOSER'S AFFIDAVIT AND SCHEDULES A THROUGH I

PROPOSER'S AFFIDAVIT

SUBMITTED TO: City of Coral Gables
Procurement Division
2800 SW 72 Avenue
Miami, Florida 33155

The undersigned acknowledges and understands the information contained in response to this RFP Schedules A through I shall be relied upon by Owner awarding the contract and such information is warranted by Proposer to be true and correct. The discovery of any omission or misstatements that materially affects the Proposer to perform under the contract shall cause the City to reject the solicitation submittal, and if necessary, terminate the award and/or contract. I further certify that the undersigned name(s) and official signatures of those persons are authorized as (*Owner, Partner, Officer, Representative or Agent of the Proposer that has submitted the attached Response*). Schedules A through I are subject to Local, State and Federal laws (as applicable); both criminal and civil.

- SCHEDULE A – CERTIFICATE OF PROPOSER
- SCHEDULE B – NON-COLLUSION AND CONTINGENT FEE AFFIDAVIT
- SCHEDULE C – DRUG-FREE STATEMENT
- SCHEDULE D – PROPOSER'S QUALIFICATION STATEMENT
- SCHEDULE E – STATEMENT OF NO-RESPONSE
- SCHEDULE F – CODE OF ETHICS, CONFLICT OF INTEREST, AND CODE OF SILENCE
- SCHEDULE G – AMERICANS WITH DISABILITIES ACT (ADA)
- SCHEDULE H – PUBLIC ENTITY CRIMES
- SCHEDULE I – ACKNOWLEDGEMENT OF ADDENDA

This affidavit is to be furnished to the City of Coral Gables with its RFP response. It is to be filled in, executed and notarized by the Proposer. If the Response is made by a Corporation, then it should be executed by its Chief Officer. This document MUST be submitted with the Response.

I. PROPOSER'S AFFIDAVIT AND SCHEDULES A THROUGH I

STATE OF FLORIDA

COUNTY OF MIAMI-DADE

On this 5TH day of JUNE, 2017, before me the undersigned Notary Public of the State of FLORIDA, personally appeared SENEN M. A. ANTONIO
(Name(s) of individual(s) who appeared before Notary

And whose name(s) is/are subscribes to within the instrument(s), and acknowledges it's execution.

Torika Alonso-Burford
NOTARY PUBLIC, STATE OF FLORIDA

TORIKA ALONSO-BURFORD
(Name of notary Public; Print, Stamp or Type as Commissioned.)

Personally know to me or Produced Identification:

(Type of Identification Produced)

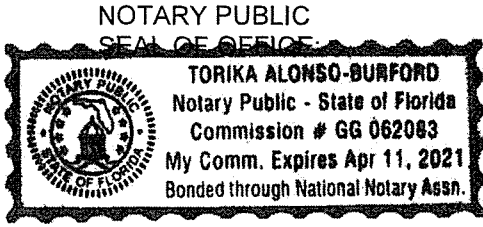

I. PROPOSER'S AFFIDAVIT AND SCHEDULES A THROUGH I

SCHEDULE "A" CITY OF CORAL GABLES - CERTIFICATE OF PROPOSER

Neither I, nor the above firm, I here represent has:

- a. employed or retained for a commission, percentage brokerage, contingent fee, or other consideration, any firm or person (other than a bona fide employee working solely for me or the above Proposer) to solicit or secure this contract.
- b. agreed, as an express or implied condition for obtaining this contract, to employ or retain the services of any firm or person in connection with carrying out the contract, or
- c. paid, or agreed to pay, to any firm, organization or person (other than a bona fide employee working solely for me or the above Proposer) any fee, contribution, donation or consideration of any kind for, or in connection with, procuring or carrying out the contract except as here expressly stated (if any):

SCHEDULE "B" CITY OF CORAL GABLES - NON-COLLUSION AND CONTINGENT FEE AFFIDAVIT

1. He/she is the PARTNER
(*Owner, Partner, Officer, Representative or Agent*)
of the Proposer that has submitted the attached Response.
2. He/she is fully informed with respect to the preparation and contents of the attached Response and of all pertinent circumstances respecting such Response;
3. Said Response is made without any connection or common interest in the profits with any other persons making any Response to this solicitation. Said Response is on our part in all respects fair and without collusion or fraud. No head of any department, any employee or any officer of the City of Coral Gables is directly or indirectly interested therein. If any relatives of Proposer's officers or employees are employed by the City, indicate name and relationship below.

Name: N/A Relationship: N/A
Name: _____ Relationship: _____

1. No lobbyist or other Proposer is to be paid on a contingent or percentage fee basis in connection with the award of this Contract.

SCHEDULE "C" CITY OF CORAL GABLES - VENDOR DRUG-FREE STATEMENT

Preference may be given to vendors submitting a certification with their bid/proposal certifying they have a drug- free workplace in accordance with Section 287.087, Florida Statutes. This requirement affects all public entities of the State and becomes effective January 1, 1991. The special condition is as follows:

1. Publish a statement notifying employees that the unlawful manufacture, distribution, dispensing, possession, or use of a controlled substance is prohibited in the workplace and specifying the actions that will be taken against employees for violations of such prohibition.
2. Inform employees about the dangers of drug abuse in the workplace, the business's policy of maintaining a drug-free workplace, any available drug counseling, rehabilitation, and employee assistance programs, and the penalties that may be imposed upon employees for drug abuse violations.
3. Give each employee engaged in providing the commodities or contractual services that are under solicitation a copy of the statement specified in subsection (1).
4. In the statement specified in subsection (1), notify the employees that, as a condition of working on the commodities or contractual services that are under solicitation, the employee will abide by the terms of the statement and will notify the employer of any conviction of, or plea of guilty or nolo contendere to, any violation of chapter 893 or of any controlled substance law of the United States or any state, for a violation occurring in the workplace no later than five (5) days after such conviction.
5. Impose a sanction on, or require the satisfactory participation in a drug abuse assistance or rehabilitation program if such is available in the employee's community, by any employee who is so convicted.
6. Make a good faith effort to continue to maintain a drug-free workplace through implementation of this section. As the person authorized to sign the statement, I certify that this form complies fully with the above requirements.

I hereby certify that the company submitting this solicitation has established a Drug Free work place program in accordance with Sate Statute 287.087

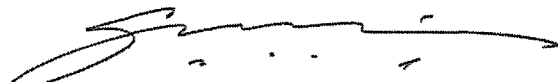

SENE M. A. ANTONIO, PARTNER
DPZ PARTNERS, LLC dba DPZ CoDESIGN
JUNE 06, 2017

I. PROPOSER'S AFFIDAVIT AND SCHEDULES A THROUGH I

SCHEDULE "D" CITY OF CORAL GABLES – PROPOSER'S QUALIFICATION STATEMENT

The undersigned certifies under oath the truth and correctness of all statements and all answers to questions made hereinafter:

Company Name: DPZ PARTNERS, LLC dba DPZ CoDESIGN

Address: 1023 SW 25TH AVENUE, MIAMI, FLORIDA 33135
Street City State Zip Code

Telephone No: (305) 644 1023 Fax No: (305) 644 1021 Email: senen@dpz.com

How many years has your organization been in business under its present name? 12 Years

If Proposer is operating under Fictitious Name, submit evidence of compliance with Florida Fictitious Name Statue:

Under what former names has your business operated? : DUANY PLATER-ZYBERK & COMPANY, LLC

At what address was that business located? SAME AS ABOVE

Are You Certified? Yes No _____ If Yes, **ATTACH COPY** of Certification.
Are You Licensed? Yes No _____ If Yes, **ATTACH COPY** of License See next two pages.

Has your company or its senior officers ever declared bankruptcy?

Yes _____ No If yes, explain: _____

Please identify each incident within the last five (5) years where (a) a civil, criminal, administrative, other similar proceeding was filed or is pending, if such proceeding arises from or is a dispute concerning the Proposer's rights, remedies or duties under a contract for the same or similar type services to be provided under this RFP;
N/A

Have you ever been debarred or suspended from doing business with any government entity?

Yes _____ No If Yes, explain _____

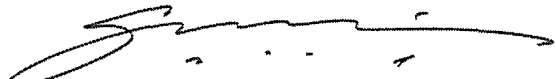
SENE M. A. ANTONIO, PARTNER
DPZ PARTNERS, LLC dba DPZ CoDESIGN
JUNE 06, 2017

I. PROPOSER'S AFFIDAVIT AND SCHEDULES A THROUGH I

RICK SCOTT, GOVERNOR

KEN LAWSON, SECRETARY

STATE OF FLORIDA
DEPARTMENT OF BUSINESS AND PROFESSIONAL REGULATION
BOARD OF ARCHITECTURE & INTERIOR DESIGN

LICENSE NUMBER

AAC000845

The ARCHITECT CORPORATION
Named below IS CERTIFIED
Under the provisions of Chapter 481 FS.
Expiration date: FEB 28, 2019

DPZ PARTNERS, LLC
PLATER-ZYBERK ARC HITECTS INC
1023 SW 25TH AVENUE
MIAMI FL 33135



ISSUED: 12/20/2016

DISPLAY AS REQUIRED BY LAW

SEQ # L1612200001833



State of Florida
*Minority, Women &
Service-Disabled Veteran*
Business Certification

DPZ Partners, LLC

Is certified under the provisions of
287 and 295.187, Florida Statutes for a period from:

January 25, 2016 to January 25, 2018

Torey Alston, Executive Director

Florida Department of Management Services
Office of Supplier Diversity

Office of Supplier Diversity * 4050 Esplanade Way, Suite 380 * Tallahassee, FL 32399-0950 * 850.487.0915 * www.osd.dms.state.fl.us

State of Florida

Department of State

I certify from the records of this office that DPZ PARTNERS, LLC is a limited liability company organized under the laws of the State of Florida, filed on March 21, 2005.

The document number of this limited liability company is L05000027973.

I further certify that said limited liability company has paid all fees due this office through December 31, 2017, that its most recent annual report was filed on January 9, 2017, and that its status is active.

*Given under my hand and the
Great Seal of the State of Florida
at Tallahassee, the Capital, this
the Ninth day of January, 2017*



Ken DeFronzo
Secretary of State

Tracking Number: CC1269270024

To authenticate this certificate, visit the following site, enter this number, and then follow the instructions displayed.

<https://services.sunbiz.org/Filings/CertificateOfStatus/CertificateAuthentication>

I. PROPOSER'S AFFIDAVIT AND SCHEDULES A THROUGH I

**SCHEDULE "F" CITY OF CORAL GABLES – CODE OF ETHICS, CONFLICT OF INTEREST,
AND CODE OF SILENCE**

THESE SECTIONS OF THE CITY CODE CAN BE FOUND ON THE CITY'S WEBSITE, UNDER GOVERNMENT, CITY DEPARTMENT, PROCUREMENT, PROCUREMENT LINKS, ORDINANCE NO. 2009-53; SEC 2-1055; SEC 2-677; AND SEC 2-1059, RESPECTIVELY.

IT IS HEREBY ACKNOWLEDGED THAT THE ABOVE NOTED SECTIONS OF THE CITY OF CORAL GABLES CITY CODE ARE TO BE ADHERED TO PURSUANT TO THIS SOLICITATION NO. 2017.05.MS

**SCHEDULE "G" CITY OF CORAL GABLES - AMERICANS WITH DISABILITIES ACT (ADA)
DISABILITY NONDISCRIMINATION STATEMENT**

I, being duly first sworn state:

That the above named firm, corporation or organization is in compliance with and agreed to continue to comply with, and assure that any sub-contractor, or third party contractor under this project complies with all applicable requirements of the laws listed below including, but not limited to, those provisions pertaining to employment, provision of programs and service, transportation, communications, access to facilities, renovations, and new construction.

The American with Disabilities Act of 1990 (ADA), Pub. L. 101-336, 104 Stat 327, 42 U.S.C. 12101,12213 and 47 U.S.C. Sections 225 and 661 including Title I, Employment; Title 11, Public Services; Title III, Public Accommodations and Services Operated by Private Entities; Title IV, Telecommunications; and Title V, Miscellaneous Provisions.

The Florida Americans with Disabilities Accessibility Implementation Act of 1993, Sections 5553.501-553.513, Florida Statutes

The Rehabilitation Act of 1973, 229 U.S.C. Section 794

The Federal Transit Act, as amended, 49 U.S.C. Section 1612
The Fair Housing Act as amended, 42 U.S.C. Section 3601-3631

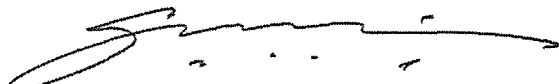

SENE M. A. ANTONIO, PARTNER
DPZ PARTNERS, LLC dba DPZ CoDESIGN
JUNE 06, 2017

I. PROPOSER'S AFFIDAVIT AND SCHEDULES A THROUGH I

SCHEDULE "H" CITY OF CORAL GABLES - SWORN STATEMENT PURSUANT TO SECTION 287.133 (3) (a), FLORIDA STATUTES, ON PUBLIC ENTITY CRIMES

1. I understand that a "public entity crime" as define in Paragraph 287.133(1)(g), **Florida Statutes**, means a violation of any state or federal law by a person with respect to and directly related to the transaction of business with any public entity or with an agency or political subdivision of any other state or of the United States, including, but not limited to, any Proposal or contract for goods or services to be provided to any public entity or an agency or political subdivision of any other state or of the United States and involving antitrust, fraud, theft, bribery, collusion, racketeering, conspiracy, or material misrepresentation.
2. I understand that "convicted" or "conviction" as defined in Paragraph 287.133(1)(b), **Florida Statutes**, means a finding of guilt or a conviction of a public entity crime, with or without an adjudication of guilt, in any federal or state trial court of record relating to charges brought by indictment or information after July 1, 1989, as a result of a jury verdict, non-jury trial, or entry of a plea of guilty or nolo contendere.
3. I understand that an "affiliate" as defined in Paragraph 287.133(1)(a), **Florida Statutes**, means:
 1. A predecessor or successor of a person convicted of a public entity crime; or 2. An entity under the control of any natural person who is active in the management of the entity and who has been convicted of a public entity crime. The term "affiliate" includes those officers, directors, executives, partners, shareholders, employees, members, and agents who are active in the management of an affiliate. The ownership by one person of shares constituting a controlling interest in another person, or a pooling of equipment or income among persons when not for fair market value under an arm's length agreement, shall be a prima facie case that one person controls another person. A person who knowingly enters into a joint venture with a person who has been convicted of a public entity crime in Florida during the preceding 36 months shall be considered an affiliate.
4. I understand that a "person" as defined in Paragraph 287.133(1)(e), **Florida Statutes**, means any natural person or entity organized under the laws of any state or of the United States with the legal power to enter into a binding contract and which Proposals or applies to Proposal on contracts for the provision of goods or services let by a public entity, or which otherwise transacts or applies to transact business with a public entity. The term "person" includes those officers, directors, executives, partners, shareholders, employees, members, and agents who are active in management of an entity.
5. Based on information and belief, the statement which I have marked below is true in relation to the entity submitting this sworn statement. **[indicate which statement applies.]**

Neither the entity submitting this sworn statement, nor any of its officers, directors, executives, partners, shareholders, employees, members, or agents who are active in the management of the entity, nor any affiliate of the entity has been charged with and convicted of a public entity crime subsequent to July 1, 1989.

The entity submitting this sworn statement, or one or more of its officers, directors, executives, partners, shareholders, employees, members, or agents who are active in the management of the entity, or an affiliate of the entity has been charged with and convicted of a public entity subsequent to July 1, 1989.

The entity submitting this sworn statement, or one or more of its officers, directors, executives, partners, shareholders, employees, members, or agents who are active in the management of the entity, or an affiliate of the entity has been charged with and convicted of a public entity crime subsequent to July 1, 1989. However, there has been subsequent proceeding before a Hearing Officer of the State of Florida, Division of Administrative Hearings and the Final Order entered by

I. PROPOSER'S AFFIDAVIT AND SCHEDULES A THROUGH I

the Hearing Officer determined that it was not in the public interest to place the entity submitting this sworn statement on the convicted vendor list.

[attach a copy of the final order]

I UNDERSTAND THAT THE SUBMISSION OF THIS FORM TO THE CONTRACTING OFFICER FOR THE PUBLIC ENTITY IDENTIFIED IN PARAGRAPH 1 (ONE) ABOVE IS FOR THAT PUBLIC ENTITY ONLY AND, THAT THIS FORM IS VALID THROUGH DECEMBER 31 OF THE CALENDAR YEAR IN WHICH IT IS FILED. I ALSO UNDERSTAND THAT I AM REQUIRED TO INFORM THE PUBLIC ENTITY PRIOR TO ENTERING INTO A CONTRACT IN EXCESS OF THE THRESHOLD AMOUNT PROVIDED IN SECTION 287.017, FLORIDA STATUTES FOR CATEGORY TWO OF ANY CHANGE IN THE INFORMATION CONTAINED IN THIS FORM.



SENEN M. A. ANTONIO, PARTNER
DPZ PARTNERS, LLC dba DPZ CoDESIGN
JUNE 06, 2017

I. PROPOSER'S AFFIDAVIT AND SCHEDULES A THROUGH I

SCHEDULE "I" CITY OF CORAL GABLES - ACKNOWLEDGEMENT OF ADDENDA

Request for Proposal (RFP) No 2015.10.26

1. The undersigned agrees, if this RFP is accepted, to enter in a Contract with the CITY to perform and furnish all work as specified or indicated in the RFP and Contract Documents within the Contract time indicated in the RFP and in accordance with the other terms and conditions of the solicitation and contract documents.
2. Acknowledgement is hereby made of the following Addenda, if any (identified by number) received since issuance of the Request for Qualifications.

Addendum No. 1 Date May 31, 2017

Addendum No. _____ Date _____

Addendum No. _____ Date _____

Addendum No. _____ Date _____

Addendum No. _____ Date _____

Addendum No. _____ Date _____



SENEN M. A. ANTONIO, PARTNER
DPZ PARTNERS, LLC dba DPZ CoDESIGN
JUNE 06, 2017

I. MINIMUM QUALIFICATION REQUIREMENTS

Per the RFP:

"the following represent the minimum qualification requirements for a Proposer to be deemed responsive by the City, and Proposers shall satisfy each of the following minimum requirements cited below. Each of these minimum qualifications must be addressed in details in its submittal to determine Proposer's responsiveness. Failure to meet each of the following qualification requirements, and/or failure to provide sufficient detail and/or documentation in its submittal to determine responsiveness by the City, will result in the submittal being deemed non-responsive.

"A. Proposer shall:

"(1) Be regularly engaged in the business of providing the goods and/or services similar in scope and size as described in the Request for Proposals "Scope of Services" for a minimum of five (5) years. In addition, Responder shall provide proof of active status or documentation evidencing Responder is currently seeking active status with the Florida Department of State, Division of Corporation."

As described on page 19 of this document, DPZ CoDESIGN (DPZ Partners; also DPZ) is a planning and urban design firm with over 36 years of experience in sustainable placemaking. We have an extensive record of collaborative work with municipalities, developers, and other professionals, ranging from the creation of main street, transit-oriented, corridor, and institutional campus plans and guidelines, to the preparation of whole city zoning codes (e.g. Miami21).

The built result of the firm's work has brought visible value to communities throughout the country. Our work with zoning codes, founded in our originating of form-based codes, encourages quick implementation and tangible results.

Proof of our active status with the Florida Department of State has been provided on page 12 of this document, while additional information on our firm and other team members are provided beginning on page 19 and succeeding pages.

"B. Key Personnel:

"(1) The Proposer's Project Manager must be a member of the American Institute of Certified Planners (AICP) in the State of Florida, with a minimum of five (5) years of documented experience in providing similar services in scope as outlined in this solicitation to government agencies at the municipal/local government level or higher.

"The years of experience for the key personnel listed above may be a combination of in-state and out-of-state experience."

As described on pages 30 and 31 of this submission, Galina Tachieva – DPZ's Managing Partner – shall be the Project Manager for this undertaking (with DPZ Founding Partner Elizabeth Plater-Zyberk as Partner-In-Charge).

Tachieva is a planner, urban designer, and architectural designer with more than twenty years of experience in sustainable urbanism, urban redevelopment, sprawl repair, and form-based codes. She completed a Master's degree in Suburb and Town Design at the University of Miami School of Architecture, and is a longstanding resident of Coral Gables. She is the author of the award-winning *Sprawl Repair Manual* (Island Press) and of the SmartCode Sprawl Repair Module.

Tachieva has led many projects of varied scales and types across the United States (including many in the State of Florida), Latin America, the Caribbean, and Europe.

I. MINIMUM QUALIFICATION REQUIREMENTS

Managing complex projects and teams, she has led charrettes and other public processes, from project initiation through implementation. A significant portion of her experience comprises leading public sector projects variously at the municipal/local, County, State, and Federal levels. She is a member of the American Institute of Certified Planners (AICP) in the State of Florida; a copy of her AICP certificate is provided on page 31 of this document.

Further details of her qualifications are provided in her resume on pages 30 and 31 of this document.

II. PROPOSER'S COMPANY BACKGROUND AND HISTORY - INTRODUCTION TO THE TEAM

Our team has been formed to support the City of Coral Gables leaders and staff in guiding the process and outcome of the proposed zoning update. We have assembled a team that is lean in numbers but rich in municipal experience in producing predictable codes that resolve the often contradictory goals of conservation/preservation and development.

LEAD CONSULTANT - DPZ CoDESIGN

DPZ CoDESIGN (DPZ) heads the project team under the leadership of Founding Partner Elizabeth Plater-Zyberk and Managing Partner Galina Tachieva (serving as Project Manager). DPZ has an extensive record of collaborative work with municipalities, developers, and other professionals, with relevant experience ranging from main street, transit-oriented, corridor, and institutional campus plans and guidelines, to whole city zoning codes (Miami21). The built result of the firm's work has brought visible value to communities throughout the country. Our work with zoning codes, founded in our originating of form-based codes, encourages quick implementation and tangible results.

Our proposed Work Plan anticipates that one or both of the Partners will be at all Work Group and public meetings. Both possess extensive experience in preparing design guidelines and codes, as well as with politically sensitive planning undertakings. Plater-Zyberk and Tachieva both reside in Coral Gables.

SUB-CONSULTANTS

The Street Plans Collaborative

The Street Plans Collaborative (Street Plans) brings value to the planning effort with the firm's familiarity and knowledge of the local development and planning context. Street Plans has undertaken planning work for the City of Coral Gables – e.g. the Coral Gables Bicycle and Pedestrian Master Plan – and maintains an office in the City.

The firm's approach to planning is highly aligned with that of DPZ; Principal Tony Garcia studied under Lizz Plater-Zyberk at the University of Miami School of Architecture, while Principal Mike Lydon was formerly employed at DPZ and collaborated with Andres Duany on writing of *The Smart Growth Manual*. As an award-winning urban planning, design, and research/advocacy firm known for advancing innovative practices to test and implement projects for a range of public, private, and non-profit clients, Street Plans' work has also given shape to topics including open streets, public market design, and public space stewardship. Street Plans shall provide planning and urban design support to DPZ in the areas of Land Use and Zoning Analysis and Coding, Active Transportation (Bicycles and Pedestrian Networks), and Street Design.

EAC Consulting, Inc.

EAC Consulting, Inc. (EAC) is a leading and award-winning engineering firm in Florida providing engineering solutions to public and private clients. With offices throughout Florida – beginning with a head office in Miami-Dade –, EAC provides engineering services that include: Civil Design, Transit/Public Transportation and Systems Engineering, and Utility Planning and Design. Since its establishment, EAC has assembled a diverse team of dedicated engineers, and other professionals who are committed to the goals of quality, client service and excellence; the firm brings civil engineering, transportation planning/design, green infrastructure, and regulatory experience to the team.

EAC has been engaged by the City of Coral Gables to provide General Engineering Consulting Services, and is a Technically Certified Firm by Miami-Dade County for Urban Area and Regional Transportation Planning. With significant implementation experience, Paul will access existing regulations and establish new and sustainable standards.



II. PROPOSER'S COMPANY BACKGROUND AND HISTORY - DPZ

DPZ CoDESIGN

DPZ CoDESIGN, also known as DPZ, is a leader in form-based planning, urban design, coding, and architecture, with over 300 projects for new and existing communities in the U.S. and internationally. DPZ's contributions to planning, design, and regulations have been widely recognized for their excellence and influence on the making of walkable urbanism, complete neighborhoods, and resilient communities.

DPZ was founded in 1980 (a 37-year old practice as of 2017) and is based in Miami, Florida, with satellite offices in Gaithersburg, Maryland and Portland, Oregon, as well as affiliates in Europe and Asia. A tightly-knit midsize company of 26, DPZ is dedicated to innovation in preserving and improving the built and natural environment. A protean organization, DPZ collaborates with others, retaining the flexibility of a small office, while providing the capacity and expertise of a larger multi-disciplinary firm.

DPZ is distinguished from other firms by its:

- ongoing pursuit of innovative solutions;
- volume of built/implemented work and the lessons learned from these projects;
- public process, including the DPZ charrette and rapid prototyping;
- business efficiency, as a small firm that collaborates with others; and
- Partners' renown in the field.

A sampling of South Florida Downtown and/or city-wide master plans and codes by DPZ (clockwise from top left: Miami21; Downtown West Palm Beach, Fifth Avenue South, Naples; and Downtown Doral.

DPZ is the recognized leader in Traditional Neighborhood Development (TND) design and our many built examples of authentic TNDs have been used as models throughout the industry to effect change in planning, regulatory, development, marketing, and financing practices. Since its founding, DPZ's growing body of work has exerted a major influence on the practice and direction of urban planning in the United States.

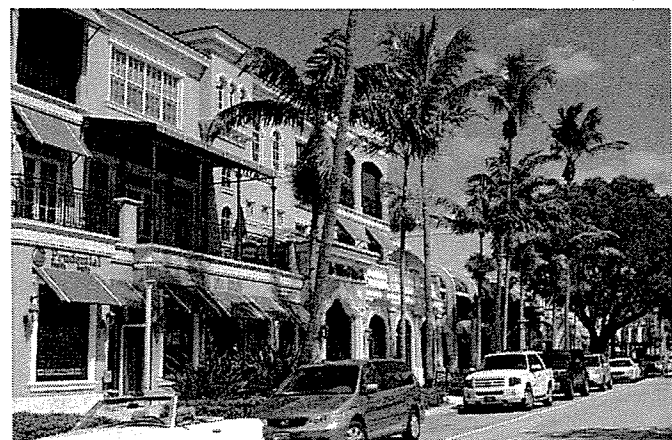
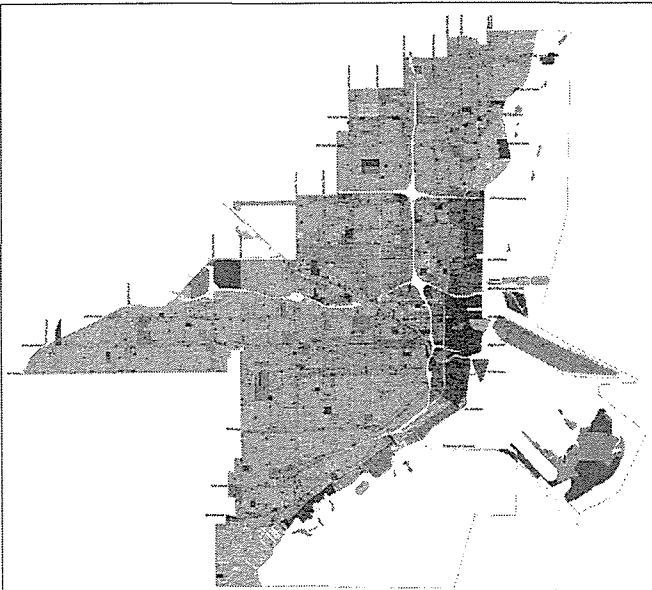

II. PROPOSER'S COMPANY BACKGROUND AND HISTORY - DPZ

As a progressive, cutting-edge think tank, DPZ's most recognized initiatives, publications, and contributions include, but are not limited to Sprawl Repair, Light Imprint, Lifelong Communities, Agrarian Urbanism, Lean Urbanism, and the Rural-to-Urban Transect.

DPZ pioneered form-based planning, design, and coding, beginning with the very first modern form-based code – that for Seaside, Florida – and subsequently developed the SmartCode, a model design and development code which has been adopted by municipalities and developers across the United States and internationally.

DPZ's form-based codes are designed to support walkable and mixed-use neighborhoods, transportation options, conservation of open lands, local character, housing diversity, and vibrant downtowns. Thus, our codes discourage sprawl development, automobile dependency, loss of open lands, monotonous subdivisions, deserted downtowns, and unsafe streets and parks. Because DPZ's form-based codes are presented in primarily graphic form, they are increasingly known as user friendly and "transparent" alternatives to conventional zoning codes.

Specifically, DPZ's SmartCode is an integrated land development ordinance, folding zoning, subdivision regulations, urban design, public works standards, and architectural controls into one compact document. It also is the only unified Transect-based code available for all scales of planning, from the region to the community to the block and building. As a form-based code, it keeps towns compact and rural lands open, while reforming the destructive sprawl-producing patterns of separated-use zoning.

The SmartCode also enables the implementation of a community's vision by coding the specific outcomes desired in particular places. It allows for distinctly different approaches in different areas within the community, unlike a one-size-fits-all conventional code. To this end, it is meant to be locally customized by professional planners, architects, and attorneys. This gives the SmartCode great political power, as it permits buy-in from stakeholders. (Note: The SmartCode serves as the chassis for many of the recent updated municipal zoning codes nation-wide and abroad, including that for Miami.)

DPZ is closely affiliated with the Form-Based Codes Institute (FBCI). DPZ Founding Partner Andres Duany is an FBCI Emeritus Board Member and an Instructor. Similarly, Duany and several other DPZ Partners are members of the Transect Codes Council, the advisory board to the Center for Applied Transect Studies (CATS).

DPZ has a strong track record of providing planning, urban design, and coding services for various successful cities and downtowns; towns and town centers; and villages throughout the United States and internationally. We possess unparalleled experience working with various authorities, agencies and municipalities, including, where required, in venues with a great degree of public engagement. In carrying public sector projects forward, DPZ intensively coordinates all stakeholders, agencies and levels of municipal governments from work order through the approval processes.

The built result of the firm's work has brought visible value to communities throughout the country. Our work with zoning codes, founded in our originating of form-based codes, encourages quick implementation and tangible results.

DPZ led the preparation of the new zoning code for the City of Miami (Miami21) approved in 2010. In addition, Plater-Zyberk led the establishment of the first Traditional Neighborhood Development (TND) code in Miami-Dade County. DPZ currently is also part of a team developing a new code for Orange County, FL.

The table on the next page shows DPZ's Form-Based Codes for various municipalities across the United States from 1988-2016 (Note: the dates show start dates).

The Rural-to-Urban Transect

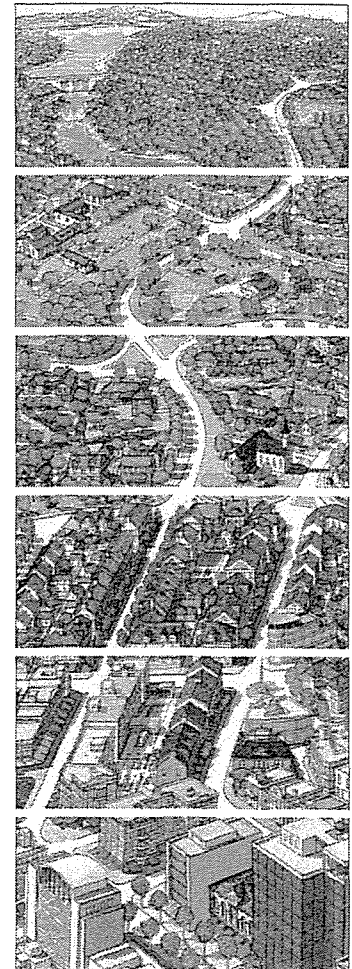

II. PROPOSER'S COMPANY BACKGROUND AND HISTORY - DPZ

DPZ Partners: FORM-BASED CODING - NATIONAL EXPERIENCE (1988 - 2016)

MUNICIPAL						
1	Orange County Code	Orange County, Florida	2016	Co-Prime	(in progress)	Sustainable Land Development Code
2	City of West Haven-TOD Code	West Haven, Connecticut	2016	Prime	TOD	Plan & Form-Based Code for TOD areas
4	Downtown Bethel	Bethel, Connecticut	2016	Prime	TOD	TOD Code
5	Tigard Triangle Code	Tigard, Oregon	2015	Co-Prime	Guidelines	Tigard Lean Code Manual
6	Reinvent Phoenix	Phoenix, Arizona	2014	Prime	TOD	Plan & Form-Based Code for TOD areas
7	Downtown Mobile	Mobile, Alabama	2013	Prime	FBC	Downtown Plan & Form-Based Code
8	BullStreet Redevelopment	Columbia, South Carolina	2012	Prime	FBC	Plan and Form-Based Code
9	Mandeville	Mandeville, Louisiana	2011	Prime	Zoning	Infill Plan and Code
10	Cobb County, Mableton	Mableton, Georgia	2011	Prime	FBC	Master Plan (438 ac) Form Based-Code (13,814 ac)
11	Miami 21	Miami, Florida	2010	Prime	FBC	Complete overhaul of City's Zoning Code to new Form-Based Code
12	Town of Taos Public Works Manual	Taos, New Mexico	2009	Prime	Guidelines	Public Works Manual
13	Cornelius Town Center	Cornelius, North Carolina	2008	Prime	TOD	Infill Plan and Code
14	St. Bernard Parish Plan	St. Bernard, Louisiana	2008	Prime	FBC	Form-Based Code for City
15	Abbeville & Vermillion Parish Plan	Vermillion Parish, Louisiana	2007	Prime	FBC	Plan and Form-Based Code
16	Unified New Orleans Plan	New Orleans, Louisiana	2006	Co-Prime	FBC	3 Comprehensive Post-Katrina Plan for New Orleans/Form-Based Code
17	Lake Charles Parish Plan	Lake Charles, Louisiana	2006	Prime	FBC	Downtown District Plan and Code
18	Down City Providence	Providence, Rhode Island	2004	Prime	FBC	Downtown Revitalization Plan and Code
19	Heart of Peoria	Peoria, Illinois	2003	Prime	FBC	Urban Infill/Downtown Plan and Form-Based Code Framework
20	Downtown Fort Myers	Fort Myers, Florida	2001	Prime	SC	Downtown Plan and SmartCode
21	Downtown Sarasota	Sarasota, Florida	2000	Prime	SC	Downtown Plan and SmartCode
22	NW Hillsborough County	Tampa, Florida	1999	Prime	FBC	Regional Plan and Code
23	Onondaga County	Onondaga County, New York	1999	Prime	TND	Regional Plan and TND Ordinance
24	Downtown Kendall	Kendall, Florida	1998	Co-Prime	FBC	Suburban Retrofit and Form-Based Code
25	Plan Baton Rouge	Baton Rouge, Louisiana	1998	Prime	TND	Downtown Plan and Form-Based Code
26	Downtown West Palm Beach	West Palm Beach, Florida	1993	Prime	TND	Downtown Corridor Plan and Form-Based Code
27	Downtown Naples/Fifth Ave	Naples, Florida	1993	Prime	FBC	Downtown Plan and Code
28	Downtown Stuart	Stuart, Florida	1988	Prime	FBC	Downtown Plan and Code

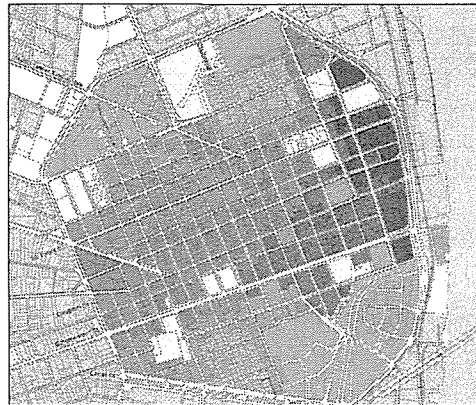

(Right) Excerpts from the Form-Based Code for Mobile, AL, by DPZ

DPZ planning and coding efforts for municipalities/government entities **undertaken and/or completed** within the last 5 years include but are not limited to those for:

Phoenix, AZ
 Orange County, FL
 Lower Merion Township, CT
 Derby, CT
 Albuquerque, NM
 Miami-Dade County, FL
 Lafayette, LA
 Tigard, OR
 Bethel, CT
 Charleston, SC
 Doña Ana County, NM
 Indian River County/St. Lucie County/
 Martin County/Palm Beach County/
 Broward County/Monroe County, FL

Baton Rouge, LA
 Port-au-Prince, Haiti
 Orem, UT
 West Haven, CT
 Birmingham, MI
 The Government of Kuwait
 Hillsborough County, FL
 High Point, NC
 Makkah, Kingdom of Saudi Arabia
 Mobile, AL
 Escambia County, FL
 Roswell, GA
 Monroe, LA

Copies of our certifications and license have been provided on pages 11 and 12 herein.

II. PROPOSER'S COMPANY BACKGROUND AND HISTORY - DPZ

SELECTED DPZ AWARDS

- 2017
 - Congress for the New Urbanism Charter Award, Blue Water Workforce & Affordable Housing, Tavernier Key, Florida
- 2016
 - Congress for the New Urbanism Merit Award, Seven50: SE Florida Prosperity Plan
 - Congress for the New Urbanism Merit Award, East End Transformation, Richmond, Virginia
- 2015
 - Inaugural Transect Codes Council (TCC) Innovation Award Winner, for Saratoga Springs, Utah
- 2014
 - Global Human Settlements Award in Planning and Design; Global Forum on Human Settlements, for Miami21
 - AIA Institute Honor Award for Regional and Urban Design; The American Institute of Architects, for Miami21
- 2013
 - Congress for the New Urbanism Charter Award, Honorable Mention, The Scottish Sustainable Communities Initiative Charrette Series Report, Scotland, UK
- 2012
 - John Nolen Medal; Congress for the New Urbanism Florida Chapter
- 2011
 - National Planning Excellence Award for Best Practice for Miami21, Miami, Florida American Planning Association (APA)
 - Congress for the New Urbanism Charter Award, Honorable Mention, for The Haitian Cabins/Les Cabanons d'Haiti
- 2010
 - Charter Award to DPZ, for Southlands: Agricultural Urbanism, Tsawwassen, Canada: Congress for the New Urbanism
 - Charter Award to DPZ, for Lifelong Communities, Atlanta, Georgia: Congress for the New Urbanism
 - Richard H. Driehaus Charitable Lead Trust Form-Based Code Award to DPZ, for Miami21, Miami, Florida
 - American Planning Association (APA) Florida Chapter Award of Excellence Best Practices for Miami21, Miami, Florida
- 2009
 - Charter Award, The Hertfordshire Guide to Growth - 2021, UK: Congress for the New Urbanism
 - Charter Award, The SmartCode: Congress for the New Urbanism
- 2008
 - "Best New Garden City" for Heulebrug, Knokke-Heist, Belgium, from the Fondation Pour L'Architecture's Prix Rotthier pour la Reconstruction de La Ville
 - Richard H. Driehaus Prize for Classical Architecture to Andres Duany and Elizabeth Plater-Zyberk
- 2007
 - Neighborhood Planning Excellence Award for East Fraserlands, Vancouver, Canada: Canadian Institute of Planners
- 2006
 - Civitas: Traditional Urbanism in Contemporary Practice, The National Building Museum, Washington, DC
- 2005
 - Best in America Living Award, Platinum Award for Outstanding Community Design, to DPZ for Habersham, Beaufort, SC
- 2004
 - Charter Award to DPZ, for NW Hillsborough County, FL: Congress for the New Urbanism

II. PROPOSER'S COMPANY BACKGROUND AND HISTORY - STREET PLANS

THE STREET PLANS COLLABORATIVE

Founded in Miami Beach in 2009, The Street Plans Collaborative (Street Plans) is an award-winning urban planning, design, and research/advocacy private firm with offices in New York City, Miami, and San Francisco. Our firm is known for advancing innovative practices to test and implement projects for a range of public, private, and non-profit clients. We have a strong track record of working collaboratively to integrate Tactical Urbanism demonstration and pilot projects with active transportation, land use, urban design, and comprehensive planning efforts.

We have successfully worked on a variety of zoning codes and urban planning projects, from Comprehensive Plans with Smart Code Applications to Form-based Codes that include an incremental approach to development with predictable, user-friendly and intuitive documents and plans. We consistently engage the public through charrettes, workshops, open forums, tactical urbanism demonstrations, social media and other creative strategies as part of our planning projects. Our personnel consist of:

- Tony Garcia, Principal, Urban Planner/Licensed Architect and Workshop Lead Facilitator
- Mike Lydon, Principal and Urban Planner/Designer and Workshop Lead Facilitator
- Sherryl Muriente, Project Director, Urban Planner/Designer and Community Engagement Facilitator
- Sam Goater, PE, Project Engineer and Planner
- Julie Flynn, Project Director, Urban Planner/Designer and Community Engagement Facilitator
- Dana Wall, Project Manager, Urban Planner/Designer and Workshop Facilitator
- Irene Balza, Project Manager, Urban Planner/Designer and Workshop Facilitator

Street Plans is also known internationally as the creator of *The Open Streets Project* and the leading practitioner of Tactical Urbanism. The firm's thought-leading publications include the 2015 Island Press book, *Tactical Urbanism: Short-term Action for Long-term Change*, as well as *Tactical Urbanism Vol. 1-5*, *Mercado: Lessons from 20 Markets in South America*, *Public Space Stewardship Guide: A Toolkit for Funding, Programming, and Maintenance* – developed for the City of San Francisco Planning Department –, and the recently published *Tactical Urbanism Guide to Materials and Design*, funded by the Knight Foundation.

Planning + Design

Active Transportation

- Comprehensive Bicycle + Pedestrian Master Plans
- Bicycle Parking Plans (Including New York City Bicycle Access Plans)
- Greenway, Path, and Trail Plans
- Bicycle and Pedestrian Network Audits
- SmartCode Bicycle Module Calibration

Transportation Planning

- Comprehensive Plan Transportation Elements
- Street Design Standards
- Street Network Planning + Design

Urban Design + Land Use Planning

- Zoning Codes and Master Plans
- Transit-Oriented Development
- Neighborhood/Corridor/Community/Regional Master Plans
- Comprehensive Plan Amendments + Land Use Policies
- Land Use + Zoning Code Analysis + Form-Based Codes

Architectural Design

- Full Architectural Services
- Building Design
- Building Type Development
- Development + Architectural Standards

Tactical Urbanism

- Lectures | Workshops | Trainings
- Research + Best Practice Development
- Demonstration Projects (1 day - 1 week)
- Pilot Projects (1 month - 1 year)
- Interim Design Projects (1 year - 5 years)
- Policy Development
- Strategy + Advising
- Metrics + Evaluation

Public Involvement

- Meeting + Workshop Facilitation
- Demonstration Projects
- Project Branding and Communications
- Project + Program Websites
- Web-Based Community Planning + Engagement Tools
- Event Planning | Marketing | Public Relations

II. PROPOSER'S COMPANY BACKGROUND AND HISTORY - EAC

EAC CONSULTING, INC.

EAC Consulting, Inc. (EAC) is a locally founded Miami-Dade based multidisciplinary engineering firm that is in its twenty-third (23) year of operations. Our firm was founded with the objective of providing engineering consulting services to public agencies, including municipalities for infrastructure improvement projects. This is embodied in our firm's vision statement, which is "To be the premier infrastructure consulting practice". Our firm's overall commitment to the practice of engineering as well as our objective to maintain excellence in the quality of our services has led to an impressive growth rate. This growth has in turn translated into EAC's ability to provide a wide range of services including planning, design criteria package development, engineering design (plans and specifications), permitting, bid process management, post design, and construction services.

With an overall staff strength of more than 75 professionals, all located in Florida, EAC has had the gracious opportunity to serve the needs of clients from South Florida up to the pan handle. Working out of three offices with headquarters in Miami-Dade County, EAC has continued to commit to providing services to our esteemed clients in a manner that ensures that their goals and constituent objectives are met.

EAC makes client service a priority - client relationships are the cornerstone of the firm's existence and will ensure repeat business. This is evident in that more than 75% of the firm workload is repeat business from existing clients. About 15% of the firm's workload is from clients that were referred to us by our existing clients. This characteristic also ensures that on assigned project's EAC's staff seek innovative solutions that bring value to our clients; whilst accomplishing two major tenets of successful projects – Early Completion and Under Budget.

To ensure that EAC's standard of excellence is maintained on projects, EAC makes a determined effort to staff projects correctly. Assigning the appropriate expertise to project assignments is a key ingredient to ensuring that clients get value for the investments in their projects. At EAC we strive to utilize the right staffing expertise and modern technology (software & platforms) to improve performance and accuracy. EAC takes pride in the delivery and quality of its product and is cognizant that continued and future success is highly dependent on the present.

One of the principles of excellent client service, is a firm's ability to respond timely even with short notice. At EAC we are focused on ensuring that the culture of satisfying our clients through prompt response as mandated by our Corporate Policies. We have built our reputation locally having worked for a considerable number of municipalities and have established an in-house corporate audit program that tracks how well and consistent this value is achieved on our projects. This component of "customer service" is extremely vital and integral to how EAC's staff conducts themselves in the process of performing technical and non-technical services.

State of Florida

Department of State

I certify from the records of this office that EAC CONSULTING, INC. is a corporation organized under the laws of the State of Florida, filed on September 6, 1994.

The document number of this corporation is P94000066488.

I further certify that said corporation has paid all fees due this office through December 31, 2017, that its most recent annual report/uniform business report was filed on January 6, 2017, and that its status is active.

I further certify that said corporation has not filed Articles of Dissolution.

*Given under my hand and the
Great Seal of the State of Florida
at Tallahassee, the Capital, this
the Sixth day of January, 2017*



Ken Detjen
Secretary of State

Tracking Number: CC1721090458

To authenticate this certificate, visit the following site, enter this number, and then follow the instructions displayed.

<https://services.sunbiz.org/Filings/CertificateOfStatus/CertificateAuthentication>

II. PROPOSER'S COMPANY BACKGROUND AND HISTORY - EAC



State of Florida
Board of Professional Engineers
 Attests that
EAC Consulting, Inc.

FBPE
FLORIDA BOARD OF PROFESSIONAL ENGINEERS

Is authorized under the provisions of Section 471.023, Florida Statutes, to offer engineering services to the public through a Professional Engineer, duly licensed under Chapter 471, Florida Statutes.
 Expiration: 2/28/2019
 Audit No: 228201901972 R

CA Lic. No:
 7011

Local Business Tax Receipt
 Miami-Dade County, State of Florida
THIS IS NOT A BILL - DO NOT PAY

LBT

EXPIRES
SEPTEMBER 30, 2017

Must be displayed in place of business
Payment to County Clerk
Chapter 84-41, F.S. 10

3626679

BUSINESS NAME/LOCATION EAC CONSULTING INC 815 NW 37 AVE 002 MIAMI FL 33136	RECEIPT NO. RENEWAL 3789278
--	--

OWNER:
EAC CONSULTING INC
Employee(s):

SEC. TYPE OF BUSINESS:
215 PLACOPARTNERSHIP

PAYMENT RECEIVED BY TAX COLLECTOR
\$45.00 08/03/2016
77PU02-16-012688

This Local Business Tax Receipt only certifies payment of the Local Business Tax. The Receiptant is not deemed, solely on a certification of the holder's qualifications, to be bonded. Holder must comply with any governmental or professional regulatory laws and requirements which apply to the business.
 The RECEIPT NO. above must be displayed on all commercial vehicles - Miami-Dade Code Sec 84-216.
 For more information, visit www.miamidade.gov/taxcollector



Office of Supplier Diversity
OSD
State of Florida

State of Florida

*Minority, Women &
Service-Disabled Veteran*

Business Certification

EAC Consulting Inc.

Is certified under the provisions of
287 and 295.187, Florida Statutes for a period from:

November 6, 2015 to November 6, 2017



Torey Alston, Executive Director

Florida Department of Management Services
Office of Supplier Diversity

Office of Supplier Diversity • 4050 Esplanade Way, Suite 380 • Tallahassee, FL 32399-0950 • 850.487.0915 • www.osd.dms.state.fl.us

II. KEY PERSONNEL - DPZ



ELIZABETH PLATER-ZYBERK FAIA CNU LEED-AP - PARTNER-IN-CHARGE

A renowned leader in community planning, Elizabeth Plater-Zyberk has expertise at every scale: from the village, to the campus, the town, the city and the region. Ms. Plater-Zyberk is a Founding Partner of DPZ Partners and the Malcom Matheson Distinguished Professor at the University of Miami School of Architecture, where she was Dean from 1995-2013. A graduate of Princeton University, she served on the Board of Trustees for 14 years and has received Honorary Doctorates from the University of Pennsylvania (2001), Notre Dame (1996), and Rollins College (1995). Plater-Zyberk is a founder of the Congress for the New Urbanism, characterized by the New York Times as "the most important phenomenon to emerge in American architecture in the post-Cold War era." She has been recognized with numerous awards. Her publications include *The New Civic Art* and *Suburban Nation*. Ms. Plater-Zyberk continues to be actively involved in architecture, master planning, and code development projects.

Selected Projects

Miami 21, Vision Plan and Form Based Code, Miami, FL
 Downtown West Palm Beach, Downtown Master Plan and Code, FL
 Downtown Kendall Master Plan, Miami, FL
 Downtown Doral Master Plan and Code, Doral, FL
 DownCity Providence Redevelopment Master Plan and Code, Providence, RI
 Downtown Stuart Master Plan, Stuart, FL
 Mississippi Renewal Forum Disaster Recovery and Renewal, 11 Gulf Coast municipalities, MS
 Design District Master Plan and Guidelines, Miami, FL
 Coconut Grove Business Improvement District Redevelopment Action Plan, Miami, FL
 Coconut Grove Streetscape Study, Miami, FL
 East End Transformation Master Plan, Richmond, VA: APA VA Award, 2011
 Rice Village Urban Infill and Streetscape Master Plan, Houston, TX
 University Mall Urban Infill/Sprawl Repair Master Plan, Provo, UT
 Amelia Park Master Plan, Fernandina Beach, FL
 Windsor Master Plan and Code, Vero Beach, FL
 Seaside Master Plan and Code, Sta. Rosa Beach, FL
 Presence Sts Mary and Elizabeth Medical Center Master Plan - West Town Visioning, Chicago, IL
 Bon Secours Memorial Regional Medical Center Campus Master Plan, Hanover Co., VA
 Bon Secours St. Francis Medical Center Campus Master Plan, Midlothian, VA
 Good Shepherd Catholic Church, Miami, FL: AIA Miami Award of Excellence, 1996
 Palmer Trinity School Campus Plan, Miami, FL

Awards and Honors

2012	Albert Simons Medal of Excellence, College of Charleston
2008	The Richard H. Driehaus Prize for Classical Architecture, ICAA
2002	Arthur Ross Award in Community Planning
2001	The Vincent J. Scully Prize, National Building Museum
2001, 1997	Honorary Doctorates, University of Pennsylvania, University of Notre Dame
1993	The Thomas Jefferson Memorial Foundation Medal in Architecture

Academic

1979-Present	Professor, University of Miami School of Architecture, with tenure
1995-2013	Dean, University of Miami School of Architecture
2008, 1998	Resident, American Academy in Rome
1980-1995	Visiting Professorships at Harvard, Maryland, Yale, and Virginia
1974	Master of Architecture, Yale School of Architecture
1972	Bachelor of Arts in Architecture and Urban Planning, Princeton University

Affiliations and Service

2008-Present	United States Commission of Fine Arts
2008-2010	Miami-Dade County Climate Change Advisory Task Force
2005-Present	Board, Institute of Classical Architecture and Art
2004	LEED Accredited Professional, U.S. Green Building Council
1996	Elected AIA College of Fellows
1993-2004	The Congress for the New Urbanism, Co-Founder and Board Member Licensed Architect, NCARB

II. KEY PERSONNEL - DPZ

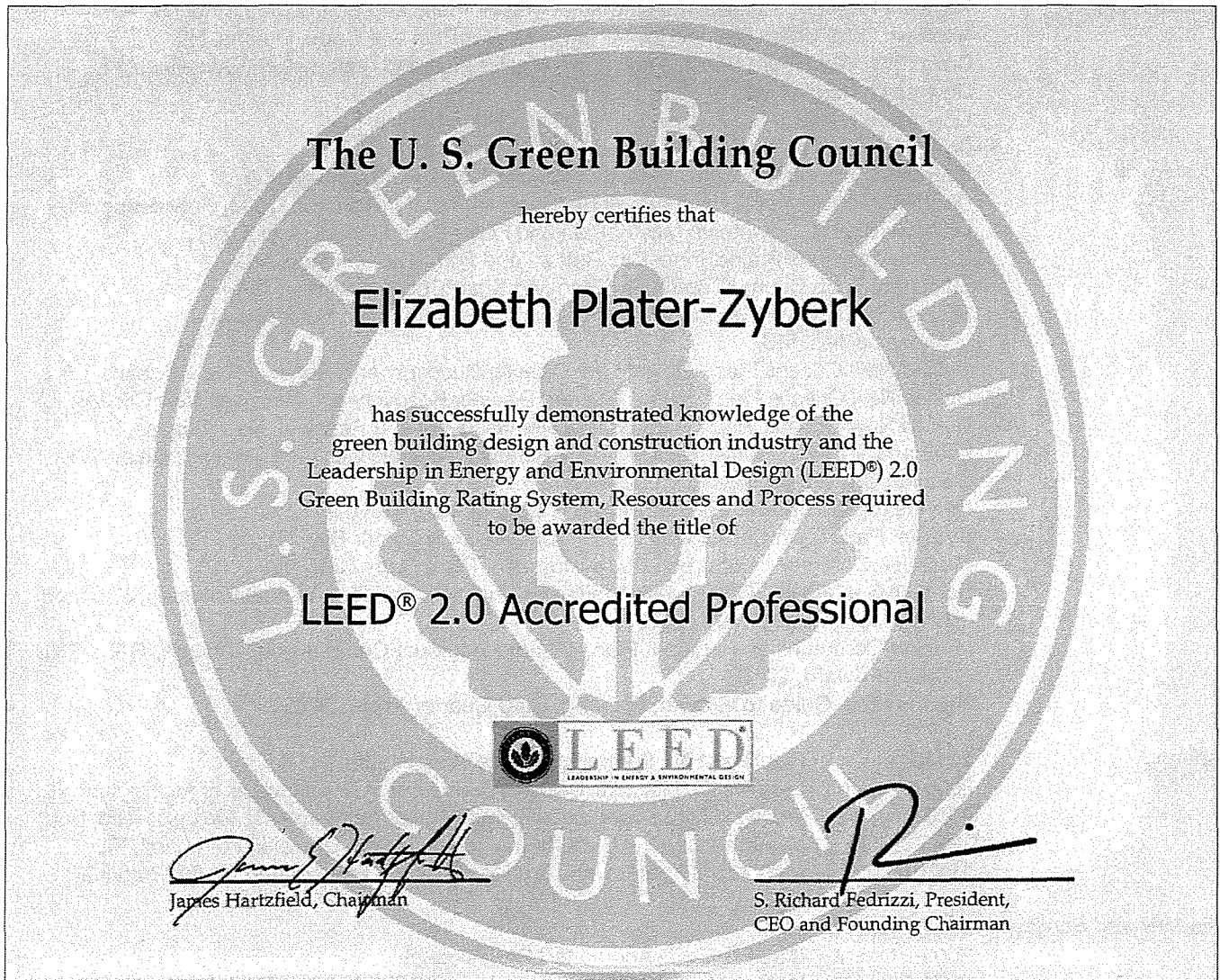
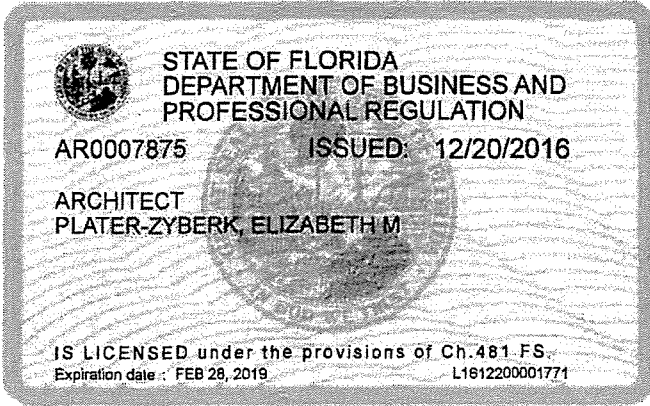

II. KEY PERSONNEL - DPZ



GALINA TACHIEVA AICP CNU PA LEED-AP - PROJECT MANAGER

Galina Tachieva currently is DPZ's Managing Partner, and is a planner, urban designer, and architectural designer with more than twenty years experience in sustainable urbanism, urban redevelopment, sprawl repair, and form-based codes. She is the author of the award-winning *Sprawl Repair Manual* (Island Press) and the SmartCode Sprawl Repair Module. She has worked on projects across the United States, Latin America, the Caribbean, and Europe, including downtowns and urban infill, environmental conservation, and commercial, retail, institutional, and residential buildings. Managing complex projects and teams, she has led charrettes and other public processes from project initiation through implementation. A Fellow of the Congress for the New Urbanism, she has been leading its national Sprawl Retrofit Initiative. She is a founding member of the Council for European Urbanism (CEU), and has been a visiting lecturer and design critic at Harvard University, at the University of Miami, and at other institutions.

Selected Projects

Reinvent Phoenix, Multiple Transit District Master Plans and SmartCode, Phoenix, AZ
 Midtown 2050 Urban District Revitalization Master Plan and Code, Omaha, NE
 Downtown West Palm Beach, Downtown Master Plan and Architectural Guidelines, FL
 Downtown Kendall Master Plan, Miami, FL
 Downtown Naples/Fifth Avenue South Master Plan, Naples, FL
 Downtown Sarasota Master Plan and Code, Sarasota, FL
 Plan Baton Rouge, Downtown Master Plan and Code, Baton Rouge, LA
 DownCity Providence, Downtown Redevelopment Master Plan and Code, Providence, RI
 Midtown Bryant, Downtown Master Plan and Form-Based Code, Bryant, AR
 Uptown Dardenne Prairie, Inner City Retrofit and Form-Based Code, MO
 Mableton/Cobb County Community Plan and SmartCode, Mableton, GA
 Mississippi Renewal Forum Disaster Recovery and Renewal, 11 Gulf Coast municipalities, MS
 Unified New Orleans Plan - Downtown: Disaster Recovery and Renewal, New Orleans, LA
 Unified New Orleans Plan - French Quarter: Disaster Recovery and Renewal, New Orleans, LA
 Unified New Orleans Plan - Gentilly: Disaster Recovery and Renewal, New Orleans, LA
 Louisiana Speaks Disaster Recovery and Renewal, multiple Gulf Coast municipalities, LA
 Coconut Grove Streetscape Study, Miami, FL
 University Mall Urban Infill/Sprawl Repair Master Plan, Provo, UT
 Syosset Park Town Center Mall Pre-Retrofit, Town of Oyster Bay, NY
 Mashpee Commons Suburban Redevelopment Plan, Cape Cod, MA
 Scottish Sustainable Communities Initiative Charrette Series, Regional Visioning, Scotland, UK: CNU Charter Award, 2013
 Lifelong Communities Regional Plan, Atlanta Regional Commission, Atlanta, GA: : CNU Charter Award, 2010
 Hertfordshire Guide to Growth, England: CNU Charter Award 2009

Academic

2015	PlanSmart NJ Summit: Keynote Presentation
2004	Lecturer, Architectural Design III, University of Miami School of Architecture, FL
2003	Visiting faculty, Post-graduate Program, Federal University, Rio de Janeiro, Brazil
1993	M. Architecture in Suburb and Town Design, University of Miami, FL
1989	M.S. Architecture, Univ. Architecture/Civil Engineering, Sofia, Bulgaria

Affiliations and Service

2011-Present	AICP
2004-Present	USGBC LEED Accredited Professional
2004-Present	Institute for Classical Architecture and Art (ICAA), Member
2004-Present	American Planning Association (APA), Member
2003-Present	The Congress for European Urbanism (CEU), Founding Member
1993-Present	The Congress for the New Urbanism, Fellow

Selected Publications

2010	<i>Sprawl Repair Manual</i> (Island Press)
2015	<i>Retrofitting Sprawl</i> , contributing author
2003	<i>The New Civic Art</i> , contributor

This certificate hereby qualifies

Galina Tachieva, AICP

as a member with all the benefits of a Certified Planner
and a commitment to the AICP Code of Ethics and Professional Conduct.

Certified Planner Number 025331

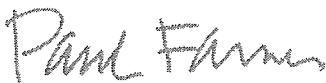

Paul Farmer, FICP
Chief Executive Officer



Anna Breinich, AICP
President



The American Planning Association's
Professional Institute

**American Institute
of Certified Planners**

Making Great Communities Happen

II. KEY PERSONNEL - DPZ



F. XAVIER IGLESIAS CNU-A - SENIOR PLANNER/DESIGNER

Xavier Iglesias is a planner and architectural designer with nearly thirty years of experience. His urban design work includes master plans and design regulations across the Transect, from rural villages to downtown revitalizations for developers, not-for-profit organizations, and municipalities. One special area of concentration has been campus design for religious and recreational institutions. Xavier leads DPZ's Healthcare Initiative, which involves campus and community visioning and urban revitalization plans for hospital systems such as Bon Secours Virginia and Presence Health.

His architectural experience includes all phases of building design, from feasibility studies and schematic design through construction documents and observation, for a variety of building types from single and multi-family residential to educational, medical and civic structures.

Selected Projects

Reinvent Phoenix, Multiple Transit District Master Plans and SmartCode, Phoenix, AZ
Downtown Naples/Fifth Avenue South Master Plan, Naples, FL
Downtown Doral Master Plan and Code, Doral, FL
Ignite High Point Downtown Master Plan/Urban Infill/Mall Retrofit/Campus Plan,
High Point, NC
Louisiana Speaks Disaster Recovery and Renewal, multiple Gulf Coast municipalities, LA
Design District Master Plan and Guidelines, Miami, FL
Coconut Grove Business Improvement District Redevelopment Action Plan, Miami, FL
Rice Village Urban Infill and Streetscape Master Plan, Houston, TX
Presence Sts Mary and Elizabeth Medical Center Master Plan - West Town Visioning,
Chicago, IL
Bon Secours Memorial Regional Medical Center Campus Master Plan, Hanover Co., VA
East End Transformation Master Plan, Richmond, VA: APA VA Award, 2011
Bon Secours St. Mary's Hospital Campus Master Plan, Richmond, VA
Bon Secours St. Francis Medical Center Campus Master Plan, Midlothian, VA
Legacy Town Center Master Plan, Plano, TX
Scottish Sustainable Communities Initiative Charrette Series, Regional Visioning, Scotland,
UK: CNU Charter Award, 2013
Lifelong Communities Regional Plan, Atlanta Regional Commission, Atlanta, GA: : CNU
Charter Award, 2010
Hertfordshire Guide to Growth, England: CNU Charter Award 2009
Town of Seaside Update 2012, Master Plan and Code, Ft. Walton Co., FL
Good Shepherd Catholic Church, Miami, FL: AIA Miami Award of Excellence, 1996
The Village of Windsor, Vero Beach, FL

Academic

1997 - Present Visiting Lecturer/ Juror University of Miami School of Architecture, FL
2009 Visiting Lecturer, King Fahd University, Dhahran, KSA
1986 B. Architecture/M. Architecture, *magna cum laude*, Tulane University, LA
Member, Tau Sigma Delta Honor Society

Affiliations and Service

2004 - Present The Florida Chapter of the Congress for the New Urbanism
1993 - Present The Congress for the New Urbanism, Charter & Accredited Member

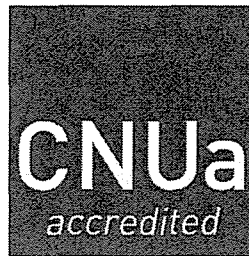

The Congress for the New Urbanism

recognizes

F. Xavier Iglesias

CNU-Accredited member

on the nomination of the faculty of

University of Miami School of Architecture

as of

December 16, 2009

A handwritten signature in black ink, consisting of a large, stylized 'R' followed by a long horizontal stroke.

Rudolphe EL-Khoury PhD
Dean & Professor of Architecture, University
of Miami School of Architecture

A handwritten signature in black ink, appearing to read "Lynn Richards" in a cursive style.

Lynn Richards
President & CEO, Congress for the New
Urbanism

II. KEY PERSONNEL - DPZ



MICHAEL E. HUSTON ARCH CNU LEED AP - SENIOR PLANNER/DESIGNER

Michael Huston is a licensed architect, urban designer, and planner with over twenty years of professional experience. His background includes many years devoted to downtown revitalization in Louisville, KY, working first with city government and subsequently in partnership with a developer; a decade of designing educational facilities; and many years in private practice.

Huston's experience in all phases of development and design has been an important contribution to his work at DPZ on master plans for downtown and urban district revitalizations, transit oriented development, and sprawl repair, as well as on the coding and the development of building type studies for those plans.

Selected Projects

Reinvent Phoenix, Multiple Transit District Master Plans and SmartCode, Phoenix, AZ
Midtown 2050 Urban District Revitalization Master Plan, Omaha, NE
Ignite High Point Downtown Master Plan/Urban Infill/Mall Retrofit/Campus Plan,
High Point, NC
Coconut Grove Business Improvement District Redevelopment Action Plan, Miami, FL
Town Madison Urban Infill/Mixed Use Town Center Master Plan and Form-based Code,
Madison, AL
Economic Development Strategic Plan, Orem, UT
University Mall Urban Infill/Sprawl Repair Master Plan, Provo, UT
Rice Village Urban Infill and Streetscape Master Plan, Houston, TX
Westview South Park Urban Infill Master Plan, Frederick, MD
Bethel Transit District Master Plan and Form-based Code, Bethel, MD
West Haven Transit District Master Plan, West Haven CT
Westside Urban Infill Master Plan, Houston, TX
Bayside District Urban Infill Master Plan, South Padre Island, TX
The Land Urban Infill Master Plan, Tulsa, OK
Syosset Park Town Center Mall Pre-Retrofit, Town of Oyster Bay, NY
Bon Secours DePaul Medical Center Campus Redevelopment Plan, Norfolk, VA
Bon Secours Memorial Regional Medical Center Campus Master Plan, Hanover Co., VA
South Point Infill Development Master Plan, Ribeirao Preto, Brazil

Academic

B. Architecture, University of Kentucky
B.A., University of Florida

Affiliations and Service

Registered Architect, Kentucky (#4170), Florida (AR# 94985)
The Congress for the New Urbanism, Member
U.S. Green Building Council (USGBC), LEED Accredited Professional

RICK SCOTT, GOVERNOR KEN LAWSON, SECRETARY



STATE OF FLORIDA
DEPARTMENT OF BUSINESS AND PROFESSIONAL REGULATION
BOARD OF ARCHITECTURE & INTERIOR DESIGN

LICENSE NUMBER

AR94985

The ARCHITECT
 Named below IS LICENSED
 Under the provisions of Chapter 481 FS.
 Expiration date: FEB 28, 2019

HUSTON, MICHAEL EDWIN
 1737 SW 10TH ST
 MIAMI FL 33135

ISSUED: 12/26/2016 DISPLAY AS REQUIRED BY LAW SEQ # L1612260001210

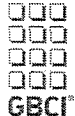

Michael Huston May 26, 2017

Michael,

The Green Building Certification Institute's records indicate that you passed the LEED® AP Exam™. The following are the details for your exam appointment:

Exam Track	Exam Date	Results
LEED AP New Construction	06/02/2009	Pass

By passing the LEED AP exam, you are now recognized as a LEED AP Legacy by GBCI. Your GBCI # is 10428089.

Thank you for your participation in the LEED® Professional Credentialing program, and we wish you luck in your endeavors towards a sustainable built environment.

Sincerely,

Credentialing Staff
 Green Building Certification Institute

GREEN BUILDING CERTIFICATION INSTITUTE | 2161 L Street NW, Suite 450, Washington, DC 20037 | T: 800.775.1746 | F: 202.626.5110 | www.gbci.org

II. KEY PERSONNEL - DPZ



JUDITH I. BELL CNU-A LEED AP - PLANNER/DESIGNER

Judith I. Bell is a planner and urban and architectural designer with twelve years of experience in a variety of project types, from regional plans and new community master plans, urban revitalization and infill plans, and design guidelines and zoning codes. She has participated in projects in North and South America, the Caribbean, Europe and China, and she has lectured on the New Urbanism and the SmartCode. She also contributes to the firm's publications and marketing process by improving and streamlining reports, book layouts and presentation graphics. Judith is fluent in both English and Spanish, received her Bachelors and Masters degrees in Architecture from the University of Miami and is a LEED-accredited professional.

Selected Projects

Miami 21, Vision Plan and Form-Based Code, Miami, FL
 Reinvent Phoenix, Multiple Transit District Master Plans and SmartCode, Phoenix, AZ
 City of Charleston, The B.A.R Process, Charleston, SC
 Bull Street, Campus Redevelopment, Community Master Plan, Form-Based Code, Columbia, SC
 New Town St. Charles, Community Master Plan and Urban Regulations, St. Charles, MO
 Scottish Sustainable Communities Initiative Charrette Series, Regional Visioning, Scotland, UK: CNU Charter Award, 2013
 Chapelton of Elswick, Community Master Plan and Urban Regulations, Aberdeen, Scotland, UK
 Grandhome, Community Master Plan, Aberdeen, Scotland, UK
 City of Charleston, The B.A.R Process, Charleston, SC
 Ave Maria School of Law, Campus Master Plan Exploration, Naples, FL
 Olowalu, Community Master Plan and Urban Regulations, Maui, HI
 Alys Beach, Community Master Plan, Walton County, FL
 Beachtown New Village, Community Master Plan, Galveston, TX
 The Land Urban Infill Master Plan, Tulsa, OK
 River District (East Fraserlands), Urban Infill Master Plan and Code, Vancouver, Canada
 Southlands Master Plan, Tsawwassen, British Columbia, Canada
 The Village at Niagara on the Lake, Community Master Plan and Urban Regulations, Toronto, Canada
 Big Bay Point Resort, Village Master Plan and Urban Regulations, Inisfill, Ontario, Canada
 Porta Norte, Community Master Plan and Code, City of Panama, Panama
 Schooner Bay, Prototypical Houses, Great Abaco Island, The Bahamas
 Xi Shui Dong, Urban Infill, Wuxi, China
 Marina Rio Lujan, Infill Village Plan, Tigre, Argentina

Academic

2004 M. Architecture in Urban Design, University of Miami, FL
 2003 B. Architecture, *cum laude*, Minor in Business Administration, University of Miami, FL

Affiliations and Service

CNU-Accredited Professional, Congress for New Urbanism
 LEED Accredited Professional, US Green Building Council

Selected Publications and Lectures

2014 - Present Guest Juror, University of Miami School of Architecture
 2012 Graphics Editor, *Garden Cities: Theory & Practice of Agrarian Urbanism*, (The Prince's Foundation)
 2011 Lecturer, Smartcode Calibration 202, Congress of New Urbanism (CNU 19), Madison, WI
 2010 Lecturer, "Principles of New Urbanism", Universidad Americana de Asunción, Paraguay
 2010 Contributor, *Sprawl Repair Manual*, (Island Press)

CNU

The Congress for the New Urbanism
on the nomination of the faculty of the
University of Miami
School of Architecture
recognizes

Judith Bell

as a CNU Accredited Member

DATE
December 16, 2009



Elizabeth Plater-Zyberk
ELIZABETH PLATER-ZYBERK
Dean
University of Miami
School of Architecture

John Noguist
JOHN NOGUIST
President and CEO
Congress For the
New Urbanism

THE UNIVERSITY OF MIAMI
SCHOOL OF ARCHITECTURE
PRESENTS A

CERTIFICATE OF COMPLETION
TO
JUDITH BELL
FOR SUCCESSFUL COMPLETION OF
THE PRINCIPLES AND PRACTICE OF NEW URBANISM
ON THE TWENTY-SECOND OF DECEMBER, TWO THOUSAND NINE

Elizabeth Plater-Zyberk
ELIZABETH PLATER-ZYBERK, DEAN

Charles C. Bell
CHARLES C. BELL, Ph.D., DIRECTOR



U.S. Green Building Council

HEREBY CERTIFIES THAT

Judith Bell

HAS ACHIEVED THE DESIGNATION OF

LEED ACCREDITED PROFESSIONAL

BY DEMONSTRATING THE KNOWLEDGE OF GREEN BUILDING PRACTICE
REQUIRED FOR SUCCESSFUL IMPLEMENTATION OF THE LEADERSHIP IN ENERGY
AND ENVIRONMENTAL DESIGN (LEED) GREEN BUILDING RATING SYSTEM.

[Signature]
Chairman

Date issued:
November 15, 2006

[Signature]
S. Richard Fejzic, President, CEO and Founding Chairman

Printed on 100% Recycled Paper | 1-800-452-7272 | www.usgbc.org

II. KEY PERSONNEL - STREET PLANS

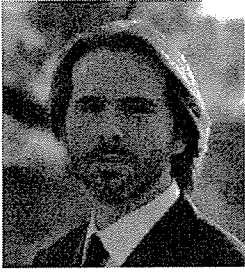

ANTHONY GARCIA

Principal, The Street Plans Collaborative

Tony Garcia is a Principal of Street Plans Collaborative, and leads the firm's Miami office. Anthony is a nationally recognized architect, writer, speaker, and advocate in the field of transit, pedestrian, and bicycle infrastructure.

As a writer and advocate, Tony's work has appeared in, or been featured by, The Daily Business Review, Atlantic Cities, Next American City Magazine, New Urban News, The Real Deal, Momentum Magazine, Streetsblog, the Miami Herald, the El Paso Times, and The Miami New Times, among other publications. Tony is a coauthor of the globally acclaimed series Tactical Urbanism: Short-Term Action, Long-Term Change Vol. 2. Together with Mike Lydon, Tony is the recipient of the 2017 Seaside Prize and co-author of the full-length book Tactical Urbanism, published by Island Press in March 2015, named by Planetizen as one of the top 10 books of the year. He is a part-time adjunct faculty member at the University of Miami School of Architecture, and co-founded the Ludlam Trail project, which will result in the addition of over 50 acres of new park space in Miami-Dade County.

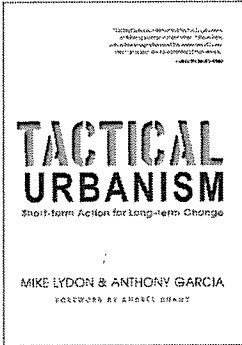

Tactical Urbanism: Short-term Action for Long-term Change was published by Island Press and ranked by Planetizen as a top 10 planning book in 2015.

Education

- University of Miami School of Architecture, Masters of Architecture, 2005.
- University of Miami School of Architecture, Rome Program for City Planning, 2003.
- Harvard University, Graduate School of Design Summer Architecture Program, 2002.
- New York University, B.A. Urban Planning & Architecture, 2002.

Relevant Project Experience

Principal || The Street Plans Collaborative || Miami, FL, 2010 - Present

- Miami-Dade Transportation Quick-Build Program, Miami, FL
- Biscayne Green Tactical Urbanism Pilot Project, Miami, FL
- BikeNWA Tactical Urbanism Pilot Projects, Northwest Arkansas
- The Tactical Urbanist's Guide to Materials + Design, 2016
- Village and Barrio Master Plan and Tactical Urbanism Plaza Project, Carlsbad, CA
- Bayfront Parkway, Miami, FL, Tactical Urbanism Pop-up Park
- Ludlam Days Demonstration Projects, Miami, FL
- Somerville By Design – East Somerville Neighborhood Master Plan and Demonstration Project, Somerville, MA
- Downtown Demonstration Project and Form-Based Code, San Marcos, TX
- Kootenai Cut-Off Road Pedestrian Improvement Demonstration Project, Ponderay, ID
- Ponderay Greenways and Pathways Master Plan, Ponderay, ID
- Village of Pinecrest U.S. 1 Mobility Plan, Pinecrest, FL
- Miami Beach Bicycle Master Plan and Street Design Guide, Miami Beach, FL
- University of Miami Pedestrian Safety Study
- Northwest Community Master Plan, El Paso, TX, SmartCode Application
- El Paso, TX Plan El Paso TX Citywide Bicycle Atlas, Handlebar Survey
- Brighton Boulevard, Denver, CO, Context-Sensitive Street Design Plan and Technical Assistance
- Mission Valley Infill Master Plan, El Paso, TX, SmartCode Application
- El Paso, TX Plan El Paso Comprehensive Plan, Charrette, and Website

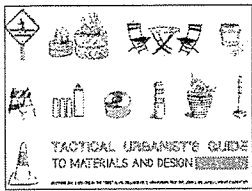

Tactical Urbanist's Guide to Materials and Design Version 1.0 published in December 2016.

II. KEY PERSONNEL - STREET PLANS

RICK SCOTT, GOVERNOR

KEN LAWSON, SECRETARY

STATE OF FLORIDA
DEPARTMENT OF BUSINESS AND PROFESSIONAL REGULATION
BOARD OF ARCHITECTURE & INTERIOR DESIGN

LICENSE NUMBER

AR97799

The ARCHITECT
Named below IS LICENSED
Under the provisions of Chapter 481 FS.
Expiration date: FEB 28, 2017

GARCIA, ANTHONY TEPEDINO
6815 SW 57TH TERRACE
MIAMI FL 33143



ISSUED: 09/06/2015

DISPLAY AS REQUIRED BY LAW

SEQ # L1509060000393

II. KEY PERSONNEL - STREET PLANS

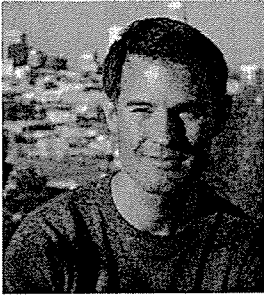

MIKE LYDON

Principal, The Street Plans Collaborative

Mike Lydon is a Principal of Street Plans, leading the firm's New York office. Mike is an internationally recognized planner, writer, speaker, and advocate for livable cities. NPR, The New York Times, CNN Headline News, ABC News, City Lab, Planetizen, Salon, Next City, and Streetsblog have featured his work, among other publications.

Mike is the creator and primary author of the The Open Streets Project and the globally acclaimed digital series Tactical Urbanism: Short-Term Action, Long-Term Change Vol.1 – 4. With Tony Garcia, Mike is the recipient of the 2017 Seaside Prize and co-author of the full-length book Tactical Urbanism, published by Island Press in March 2015 and honored by Planetizen as one of the top ten planning books of the year. Mike also collaborated with Andres Duany and Jeff Speck in writing The Smart Growth Manual, published by McGraw-Hill in 2009, which was honored by Planetizen as one of the top ten planning books of 2010.

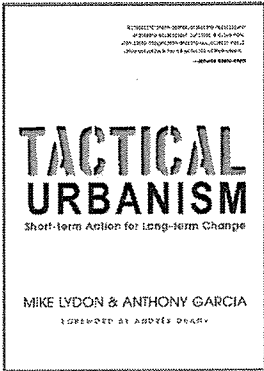

Tactical Urbanism: Short-term Action for Long-term Change was published by Island Press and ranked by Planetizen as a top 10 planning book in 2015.

Education

- University of Michigan, Master of Urban Planning, Physical Planning, 2007.
- EDAW Inc., Transit-Oriented Development Research Fellow, Nov. 2006 – Aug. 2007.
- Bates College, B.A. American Cultural Studies, 2004.

Relevant Project Experience

Principal || The Street Plans Collaborative || Brooklyn, NY, 2009 - Present

- The Tactical Urbanist's Guide to Materials + Design, 2016
- BikeNWA Tactical Urbanism Pilot Projects, Northwest Arkansas
- PlanBTV Walk/Bike Master Plan + Placemaking/Demonstration Project Implementation, Burlington, VT
- Monterey Road Complete Streets Demonstration Project, Morgan Hill, CA
- Complete Streets Rapid Delivery Workshop, Auckland, New Zealand
- ARC "Lifelong Communities" Demonstration Project, Atlanta, GA
- Fairmount Station Placemaking Plan, Boston, MA
- Activate Auckland Place Activation Program for Auckland City Center, Auckland, New Zealand
- Public Space Stewardship Guide: A Toolkit for Funding, Programming, and Maintenance, San Francisco, CA
- Make My Park Pop! Placemaking Implementation, Penrith, Australia
- Davis Square Neighborhood Plan + Plaza Demonstration Project, Somerville, MA
- East Somerville Neighborhood Plan and Placemaking Implementation Project, Somerville, MA
- Washington Gateway Main Street I-93 Underpass Activation Project, Boston, MA
- Scott Street and Business Circle Demonstration Projects, San Jose, CA
- Village and Barrio Master Plan and Tactical Urbanism Plaza Project, Carlsbad, CA
- Linda Vista Library Plaza Placemaking Delivery Project, San Diego, CA
- Tactical Urbanism Workshop and Implementation Plan, Hamilton, ON
- East Market Street Streetscape Demonstration Project, Louisville, KY
- Kootenai Cut-Off Road Pedestrian Improvement Demonstration Project, Ponderay, ID
- Trailnet Streets For Everyone Guide, St. Louis, MO

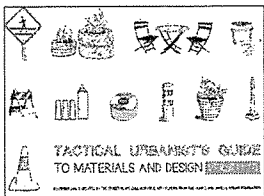

Tactical Urbanist's Guide to Materials and Design Version 1.0 published in December 2016.

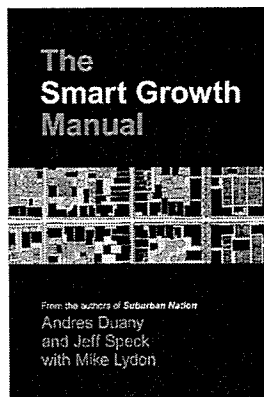

The Smart Growth Manual was published by McGraw-Hill and ranked by Planetizen as a top 10 plan-



SHERRYL MURIENTE

Project Director, The Street Plans Collaborative

Sherryl is a Project Director at Street Plans' Coral Gables office with a strong background in urban acupuncture, design and architecture, and teaching urban design courses and workshops. She has also collaborated on projects in Taiwan, Italy, Puerto Rico, and South Florida.

Prior to joining Street Plans, Sherryl worked as an urban design instructor at Florida Atlantic University, where she managed an international exchange program, mentored students, and researched and presented her work in tactical urbanism, community storytelling, and the human layer of planning and design. Sherryl has also served as the Creative Director of LeJobart, artist duet, in which she has curated and managed large-scale public art projects. She has worked on an array of community engagement projects that use tactical urbanism demonstration techniques and processes for community-led interventions, alleyway restorations, and parklet studies.

As part of her grant work, Sherryl has also managed the first Office of Public Life in the US, as an urban lab, with Gehl Studio in the City of West Palm Beach. Her work in Artena, Italy, has been featured as part of a biourbanism documentary, *ReGeneration City*. An advocate for common sense urbanism, incremental urban planning, and testing of demonstrations and pilot studies, Sherryl brings an expertise in getting the community engaged in activating place through action. She is an elected councilor for the National Strategic Council of the American Institute of Architects, and an appointed member of the Florida Architects Political Action Committee. She is fluent in Spanish and French.

Education

- Florida Atlantic University, Master of Urban and Regional Planning, 2009.
- Florida Atlantic University, Bachelor of Architecture, 2007.

Relevant Project Experience

Project Director || The Street Plans Collaborative || Miami, FL, 2016 - Present

- Happy City Shore to Core Wellness Survey, West Palm Beach, FL
- Public Space Public Life Survey, West Palm Beach, FL
- Biscayne Green Tactical Urbanism Pilot Project, Miami, FL
- BikeNWA Tactical Urbanism Pilot Projects, Northwest Arkansas
- The Tactical Urbanist's Guide to Materials + Design, 2016
- Poughkeepsie City Center Connectivity, Poughkeepsie, NY

Creative Director || LeJobart || West Palm Beach, FL, 2012 -2016

- CityZen Garden Art Park for Broadstone Residential, West Palm Beach, FL
- Office of Public Life with Gehl Studio, West Palm Beach, FL
- The Megaphone Community Engagement, West Palm Beach, FL
- Story Share & the Megaphone: Sistrunk Community Hub, Ft. Lauderdale, FL
- Street Balcony Pilot Parklet Project, West Palm Beach, FL
- C'est la Via: Rethinking the Alleyways, West Palm Beach, FL
- ArtPARK & ArtCUBES for Continuum, West Palm Beach, FL
- (Park)ing Day Demonstration, West Palm Beach, FL
- CAAP Art: LaLa Urban Acupuncture at the Garden, Lauderdale Lakes, FL
- Auguraculum Colletivo: Urban Storytelling, Segni, Rome, Italy
- La Maastra: The Bread Story Artena, Rome, Italy

II. KEY PERSONNEL - STREET PLANS



IRENE BALZA

Project Manager, The Street Plans Collaborative

Irene Balza is a project manager at Street Plans Collaborative at the firm's Miami office. She has a background in architecture and sustainable design for urban planning and design projects.

Prior to joining Street Plans, Irene worked with the Miami Downtown Development Authority on various urban design, transportation, and street-improvement projects. While at the Miami DDA, she was part of the design team for Biscayne Green, a one-month public space installation in the heart of Downtown Miami, and for a Complete Streets design initiative on SE/SW 1st St. She produced site designs and proposals and also worked on design award submissions for the various design projects.

In addition to having experience with the City of Miami, Irene also has a strong background in urban design after working with Duany Plater-Zyberk & Co. During her internship, she worked on generating RFP's and design presentations for the clients, as well as producing site drawings and plans for the design charettes.

Irene has earned a Bachelor of Architecture and is currently pursuing a Master of Urban Design and Development at the University of Miami. While pursuing her degree, she participated in the Southeast Florida Regional Climate Change Compact with community leaders and experts to develop full resilient design concepts for the Florida Climate Institute (FCI) to serve as model approaches for communities facing similar challenges.

Education

- University of Miami, Bachelor of Architecture, 2016.

Relevant Project Experience

Project Manager || The Street Plans Collaborative || Miami, FL, May 2017 - Present

- Magic City TUP Site Plan Proposal and Permitting, Miami, FL

Urban Planning and Transportation Designer || Miami DDA || Miami, FL || 2015-2017

- Biscayne Green Tactical Urbanism Pilot Project. Miami, FL
- SE SW 1st St. Complete Streets Project. Miami, FL
- Miami Baywalk and Riverwalk Signage and Wayfinding Guide. Miami, FL

Urban Designer || Duany Plater Zyberk || Miami, FL || 2013 - 2014

- Coding and Implementation Plan for Historic District for the City of Charleston, SC
- Oyster Bay, NY Master Plan design for a mixed-use village



MICHAEL ADEIFE, P.E.

Principal-in-Charge

Michael Adeife, P.E. has more than 23 years of combined design / management of engineering and construction experience. His engineering experience is extensive and yet diverse and encompasses transportation, utilities, urban planning, civil design, stormwater/hydraulics design and management and land development. Mr. Adeife has successfully held positions that range from Design engineer to Project Manager to Vice President, and as such is familiar with every aspect of consulting engineering. Mr. Adeife's proven skills as a certified professional engineer / manager, his diverse engineering experience, and his commitment to delivery of quality, on schedule and budget controlled projects have propelled his success and continue to drive his passion to perform to the highest level of service.

RELEVANT EXPERIENCE

Miami International Airport Central Boulevard Modifications- Miami Dade County

Engineer responsible for traffic analysis of existing and future conditions for the MIA Central Boulevard expansion and realignment project. Project required the modeling of Central Boulevard as a freeway using CORSIM Analysis & Simulation Package. The traffic tasks included the conversion of model volumes to DHVs based on the existing traffic patterns as well as the development of MOEs comparing the existing and the project year conditions.

Metrorail East-West Multi-modal Corridor Study- Miami Dade Transit Agency

Engineer responsible for the development of traffic flow analysis factors based on existing traffic volumes. Responsible for the conversion of FSUTMS model volumes to projected year design hour volumes. Mr. Adeife was responsible for all arterial intersection analysis and arterial segment analysis using applicable software. He was also responsible for the development of design hour link volumes and speeds for existing and project year scenarios; for the compilation of traffic data information for air/noise quality analysis for existing and project year scenario and for traffic analysis, simulation and the development of MOEs comparing existing and project year alternatives

MegaTransport Zone- Broward County Aviation Department

Engineer responsible for assessing the existing traffic conditions (capacity issues) as well roadway conditions – including geometry, signage, egress and ingress, traffic lane assignments, etc; within the Mega Transport Zone (Ft-Lauderdale Airport/ Port Everglades). Traffic assessment was required as part of the documentation of an issue statement detailing the need for transit and transportation infrastructure development within the Mega Transport Zone.

Engineering Assessment for Two Way Traffic Operations, NE 8th Ave. and NE 10th Ave. – City of Hallandale Beach

Project Manager responsible for this project involving a traffic assessment/study to evaluate the conversion of local/residential streets of NE 8th Avenue and NE 10th Avenue to two way traffic operating streets.

Miami-Dade MPO Congested Intersections Project - Metropolitan Planning Organization

Design Engineer responsible for the assessment adverse roadway conditions impeding the effective traffic flow and safety of roadway users for several locations within Miami-Dade County. Responsible for the provision of recommendations to eliminate such adverse conditions.

North Corridor Bus Rapid Transit (BRT) FEIS- Metropolitan Planning Organization

Engineer responsible for the analysis of existing and proposed conditions at ten major intersections as well as nine arterial segments within the north corridor. The project involves data collection relating to existing roadway geometry and configuration, socio-economic information, governmental planning, the verification and compilation of data corresponding to the existing and proposed operations of transit modes within the corridor. In addition, proposed traffic conditions were analyzed for the project year based on model generated volumes as well as pre-developed conversion factors from the existing traffic patterns. Responsible for the development of MOEs comparing existing and project year BRT alternative.

Biscayne Point Neighborhood Infrastructure Improvement - City of Miami Beach

Project Manager for the Biscayne Point Neighborhood Improvement Project that encompasses targeted potable water distribution and roadway/streetscape improvements. The project requires the design of approximately 19,000 LF of pressurized DIP water mains ranging in size from 8-inch to 16-inch and service connections to homes of more than 500 residents in Miami Beach.

YEARS OF EXPERIENCE: 23

Education

1992 Bachelor of Science in Civil Engineering – University of Lagos, Nigeria

1996 Master of Science in Civil Engineering – Florida International University

Licenses

Professional Registration: Florida – 56094

II. KEY PERSONNEL - EAC

NOTICE

FBPE no longer requires that continuing education be reported by the provider. Instead licensees will be subject to a random audit no more than every four (4) years. If you are selected for the random audit, you must provide verification of one (1) hour of Florida laws and rules, one (1) hour of professional ethics, four (4) hours of area of practice and twelve (12) hours in any topic pertaining to the practice of engineering, all taken prior to February 28, 2017. (See s. 471.017, Fl. Stat.) Any CE hours taken after February 28, 2017 will result in a \$100 delinquent fee and your license being placed in a delinquent status until the additional fee is paid.

State of Florida
Board of Professional Engineers
Attests that
Michael Adebowale Adeife, P.E.

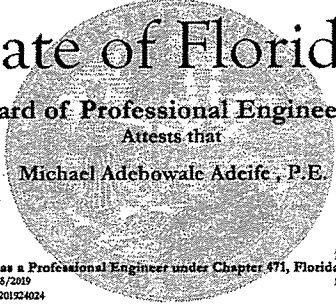

Is licensed as a Professional Engineer under Chapter 471, Florida Statutes
Expiration: 2/28/2019
Audit No: 228201924024

FBPE
P.E. Lic. No:
56094

State of Florida
Board of Professional Engineers
Attests that
Michael Adebowale Adeife, P.E.

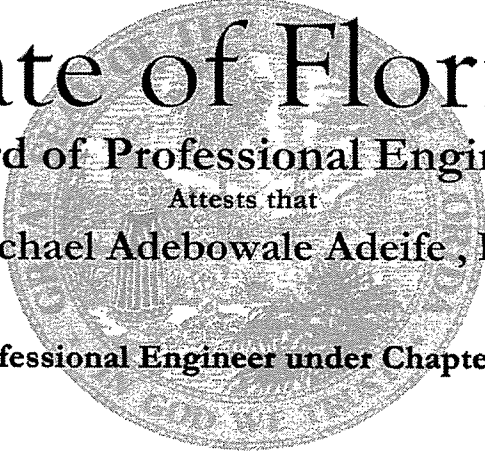

Is licensed as a Professional Engineer under Chapter 471, Florida Statutes
Expiration: 2/28/2019
Audit No: 228201924024 R



P.E. Lic. No:
56094



DAVID GILPIN-HUDSON, AICP

Project Manager

Mr. Gilpin-Hudson's career of over 30 years includes leadership roles in strategic planning, policy analysis, comprehensive planning, resource planning, best practice implementation, performance measurement, evaluation, and reporting. Mr. Gilpin-Hudson has successfully supervised numerous multi-disciplinary teams in developing and implementing regional and sub-regional plans. He has extensive experience in creating and maintaining improved efficiencies and connectivity between policy, planning, and regulatory initiatives. Mr. Gilpin-Hudson has a stellar project management success record, including comprehensive experience in conceiving, developing, implementing, and reporting on regional and local projects. These planning roles typically included significant public participation, consulting with stakeholders, and bringing about joint ownership of solutions. Mr. Gilpin-Hudson has authored many plans and reports as a primary or contributing author, some of which have been recognized by national organizations with awards. He has also successfully made numerous presentations to governing boards, local government commissions, advisory councils, charrette groups, and the public.

RELEVANT EXPERIENCE

Indian River Lagoon-South Feasibility Study

Primary author. Consulting with South Florida Engineering & Consulting (a contractor for the St. Johns River Water Management District) - prepared a literature review for project development and feasibility study to investigate future opportunities to reduce anthropogenic nutrient and sediment loads to the Indian River Lagoon through the capture and treatment of stormwater flows.

Strategic Plan - South Florida Water Management District (SFWMD)

Project manager. Aligned planning, budgeting and evaluation activities with SFWMD priorities and plans. Coordinated with the Governing Board, Executive Office and project managers to identify priorities, define performance measures, and determine agency actions for success. Managed the SFWMD Strategic Plan annually from initiation to Governing Board adoption, through implementation, performance measurement and reporting. Coordinated with the budget development process to ensure consistency between the Strategic Plan, Annual Work Plan, and budget; implemented strategic initiatives, developed metrics, evaluated and interpreted results for feedback to agency leadership and interested and affected parties. Made numerous presentations to the SFWMD Governing Board, local government commissions, advisory groups, and the public on water management issues.

South Florida Environmental Report - South Florida Water Management District (SFWMD)

Project manager. Managed the annual development of Volume II of the South Florida Environmental Report – which replaced numerous individual fiscal, capital improvement, water resource, and land management reports. Also penned South Florida Environmental Report legislative bill in coordination with DEP and Florida's other water management districts. Resulting legislation based on bill language now guides all water management districts.

Water Supply Plans - South Florida Water Management District (SFWMD)

Supervisor of regional project managers. Supervised the development and implementation of four regional water supply plans that cumulatively cover the entire SFWMD. These regional plans include analyses of shortfalls in water resources versus demand forecasts, as well as implementing projects to make the necessary water resources available. Plan development included water resource analysis through mathematical modeling; economic analyses, budgeting and project development; as well as coordination with local governments, utilities and urban, agricultural and environmental interest groups. Coordinated water supply plan implementation with the Comprehensive Everglades Restoration Plan (CERP). Prepared cost projections for projects within regional water supply plans.

Comprehensive Plan Review - South Florida Water Management District (SFWMD)

Supervisor of project managers. Supervised the SFWMD Comprehensive Plan review process to meet SFWMD responsibilities within specified deadlines. Supervised the SFWMD review of Comprehensive Plans for municipalities within the SFWMD, including Evaluation Appraisal Reports (EARs). Participated in charrette process as part of Comprehensive Planning town-hall meetings.

YEARS OF EXPERIENCE: 31

Education:

1986-Master of Science in Agricultural Engineering, University of Florida
1982-Bachelor of Science in Agricultural Economics, University of Florida

Certifications

Certified Planner, American Institute of Certified Planners (AICP)

II. KEY PERSONNEL - EAC

055985 David Gilpin-Hudson, AICP (iMIS Live Enterprise)

File Edit Cmds Help

iMIS Home Customers Billing Events AR/Cash Orders Subscriptions

Customers

Manage customers Regular Member - David Gilpin-Hudson, AICP

ID: 055985 Regular Member Active Category

Prefix: David Suffix: Gilpin-Hudson Member Title: AICP

Company: Wellington Company Sort: WELLINGTON

Work Address Home Address Street Address

Address: 15562 Cypress Park Dr Status: Address 2: Address 3: Wellington FL 33414 United States

Preferred: Mail Bill Ship

Phone: (561) 687-6784 Fax: E-mail: DO NOT ENTER

Status: Profile Ind_Demographics Financial Custom_Credit Advocacy Other Notes Custom_Credit Mailing Demographics Verification

Chapter: Florida Chapter Join Date: 2/25/1993 Paid Through Date: 3/31/2017

Renewed: 4/4/2016 Date Added: Last Update: 5/31/2012 4:39:17 PM Last Updated By: KBLANK

Results Record History Activities-All Roster Billing Dues AR/Cash Events Orders Relationships Change Log Sales Letters

Item	Status	Pad Thru	Bill Date	Amount	Payment	Balance	PR Item
APA	A	3/31/2017	1/3/2016	220.00	50.00	0.00	No
CHAPT.FL	A	3/31/2017	1/3/2016	99.00	10.00	0.00	No
AICP	A	3/31/2017	1/3/2016	125.00	25.00	0.00	No

New Delete Find Print User Credentials 1 result returned History Save Cancel

10:46 AM 7/12/2015

III. PROJECT UNDERSTANDING, PROPOSED APPROACH, AND METHODOLOGY

It is our understanding that the City of Coral Gables has initiated this rezoning project as a result of an extensive community-driven comprehensive planning process, and that the vision and policy recommendations of the Comprehensive Plan are intended to guide the new and revised regulations. The proposed update to the Zoning Code is intended to resolve and repair internal inconsistencies and conflicts, whilst maintaining the preservation of neighborhood character, improving connectedness for walkability, ensuring a predictable and easily administered framework for continued appropriate growth and appropriate development.

The DPZ team has a great admiration for the natural and built environment of Coral Gables (several of our team members, as well as many of our firms' staff, reside in the City). Its beautifully designed, historic neighborhoods; vibrant commercial areas; important institutional campuses; and lush, green landscapes and streetscapes combine to make a city of unique character.

The City's appeal is magnified by its role as a primary metropolitan area within Miami-Dade County. In this situation it is understood that development pressure from welcomed economic growth is often at odds with the goal of maintaining a cultural and built history of a different scale.

We propose a **Scope of Services** and **Work Plan** comprising a process of four Phases subdivided into fifteen Tasks. The first three of the four Phases comprise the scope described in the RFP – from Code assessment and amendment through the Code adoption process. In addition to these, and based on our extensive experience with Zoning Code efforts, we propose a fourth Phase, comprising Implementation.

In **Phase 1 Assessment and Analysis**, five Tasks are proposed, comprising Project Start-up, Analysis of Background Materials, Draft Assessment and Analysis, Final Assessment and Analysis Findings, and Revisions to the Project Schedule and Other Adjustments.

In **Phase 2 Draft Updated Zoning Code**, the five Tasks include the Draft Updated Zoning Code Development (along with the Draft Equivalency Chart), Draft Updated Zoning Map Development, Testing of Sample Conditions, Revised Draft Updated Code and Map, and Final Presentation.

Phase 3 Adoption Process includes Technical Support, Presentation Aids and Graphics, and Public Meetings.

Phase 4 Implementation includes Training Sessions and the preparation of a Guidebook and Handouts. Phases 1, 2, and 3 are envisioned to occur over twelve (12) months, per the RFP. Phase 4 provisionally is estimated to comprise an additional three (3) months.

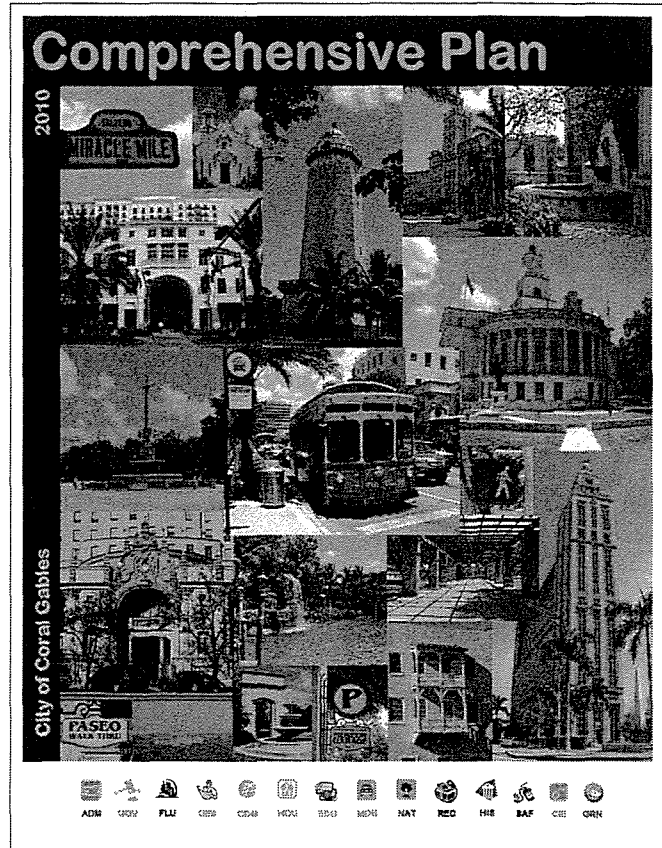

Cover to *The City of Coral Gables Comprehensive Plan (2010)*.

**CITY OF CORAL GABLES
PLANNING SERVICES FOR ZONING CODE UPDATE
PROPOSED SCHEDULE**

TASKS	MEETINGS AND PRESENTATIONS			TEAM ASSIGNMENT			PROJECT MONTH															
	Working Group (+ Staff)	Staff	Public	DPZ	Street Plans	EAC	1	2	3	4	5	6	7	8	9	10	11	12	13	14	15	
Phase 1 Assessment and Analysis (Months 1 - 3)	6 mtgs.	As needed	1 mtg.				Phase 1															
Task 1 Project Start-up	1 mtg.	✓☐		✓																		
Task 2 Interactive Analysis of Project Background Materials	2 mtgs.	✓☐		✓	✓	✓																
Task 3 Draft Assessment and Analysis	1 mtg.	✓☐		✓	✓	✓																
Task 4 Final Assessment and Analysis	1 mtg.	✓☐	1 mtg.	✓	✓	✓																
Task 5 Revisions to the Project Schedule and Other Adjustments	1 mtg.	✓☐		✓																		
Phase 2 Draft Updated Zoning Code (Months 4 - 9)	8 mtgs.	As needed	2 mtgs.				Phase 2															
Task 6 Draft Updated Zoning Code Development	2 mtgs.	✓☐		✓	✓																	
Task 7 Draft Updated Zoning Map Development	2 mtgs.	✓☐		✓	✓	✓																
Task 8 Testing of Sample Conditions	1 mtg.	✓☐		✓	✓	✓																
Task 9 Revised Draft Updated Zoning Code and Map	1 mtg.	✓☐	1 mtg.	✓	✓	✓																
Task 10 Final Presentation	2 mtgs.	✓☐	1 mtg.	✓																		
Phase 3 Adoption Process (Months 10 - 12)	1 mtg.	As needed	TBD				Phase 3															
Task 11 Technical Support	1 mtg.	✓☐		✓	✓	✓																
Task 12 Presentation Aids and Graphics		✓☐		✓																		
Task 13 Public Meetings		✓☐	✓☐	✓																		
Phase 4 Implementation (Months 13 - 15)	1 mtg.	As needed	N/A				Phase 4															
Task 14 Training Sessions	1 mtg.	✓☐		✓																		
Task 15 Guidebook and Handouts	1 mtg.	✓☐		✓																		

Project Management / Ongoing Tasks for all Phases

- Prepare support materials and graphics for meetings and public outreach
- Coordinate with Staff before meetings to determine roles and approach
- Follow up with Staff after meetings to clarify next steps
- Phone conversations, email communication, and briefings (as needed)

Notes

- The proposed Work Plan, Schedule, and Deliverables are subject to adjustment in consultation with the City of Coral Gables, upon consultant appointment.
- Specific deliverables are described in the document text.

III. PROJECT UNDERSTANDING, PROPOSED APPROACH, AND METHODOLOGY

We understand the process and deliverables must be tailored to the needs of the City. Our team possesses the flexibility and experience that enable us to adjust to evolving conditions.

The proposed final documents are an Updated Zoning Code and an Updated Zoning Map. Other documents to be used as tools for the process include analytical studies, illustrations, comparative tables (Zoning Equivalency Chart), and digital presentations, among others. Goals include: integration of Smart Growth principles, consistency with Comprehensive Plan and other regulations and policies, sustainable land use, reduction of complexity, rules that are logical, clear and easy to understand, predictability of built result, and a framework for responding to change over time.

PHASE 1 – ASSESSMENT AND ANALYSIS

Task 1: A Project Start-up meeting will be conducted to establish the process and procedures of the Project; the Project Schedule of work, production, meetings and presentations; the Work Plan Services and Deliverables; and methods of communication of proposals and progress.

Meetings: 1 meeting with City Work Group and Staff; other meetings with Staff as needed.

Task 2: An Interactive Analysis of Project Background Materials will be undertaken to document the existing conditions, regulations and procedures; to analyze and assess the same; to develop an outline of the mission and goals of the new regulations; to develop an outline of the adjustments identified as desirable by the Comprehensive Plan; to develop the structure of updated Code as; and to review the relationship of the updated Zoning Code to other existing regulations.

Deliverable: Successive PowerPoint presentations

Meetings: 2 City Work Group and Staff meetings (one of these may include a tour of the City and areas of critical concern), other meetings with Staff as needed.

Task 3: The **Draft Assessment and Analysis** comprises the draft documentation of the Interactive Analysis for public review. This includes a complete list of goals and critical concerns to address in the updated regulations.

Deliverable: PowerPoint, booklet, media communication materials

Meetings: 1 City Work Group and Staff meeting; other meetings with Staff as needed

Task 4: The **Final Assessment and Analysis** incorporates all responses to prior presentations and to the Draft

Excerpts from the Miami 21 Code and Zoning Map for the City of Miami, FL (2010).

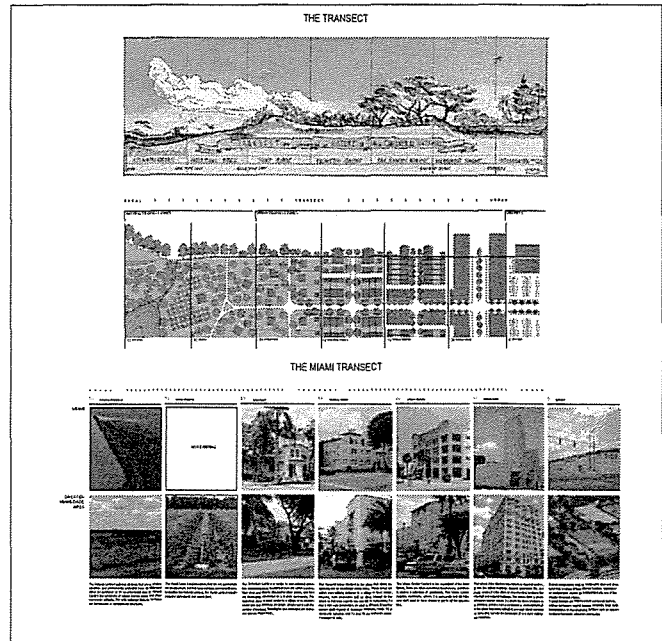

Rural-to-Urban Transect of typical Miami conditions

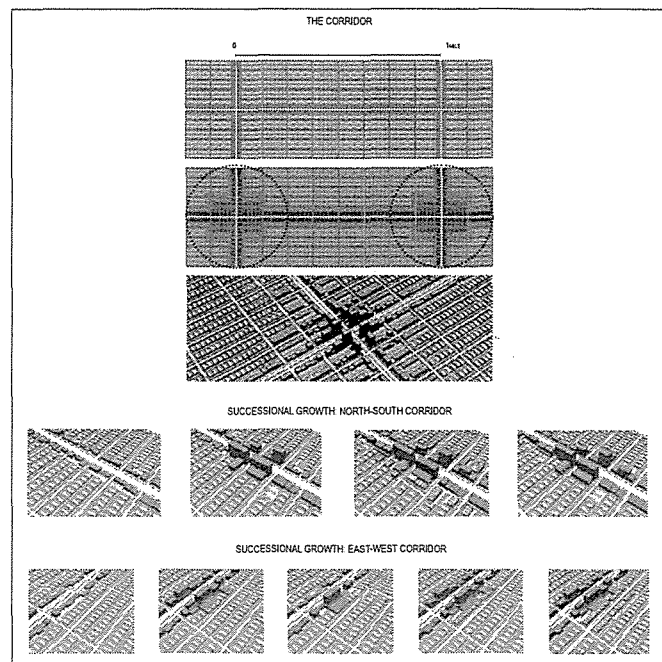

Corridor growth pattern studies of typical Miami conditions

III. PROJECT UNDERSTANDING, PROPOSED APPROACH, AND METHODOLOGY

Deliverables: Large scale paper printouts, PowerPoint, web and media communication materials

Meetings: 2 City Work Group and Staff meetings; other meetings with Staff as needed

Note: For Tasks 6 and 7, a multi-day workshop or Charrette may be added to engage topics specifically and to enable a condensed and iterative process.

Task 8: The Testing of Sample Conditions examines a number of master plan, urban design, and building development conditions, identified during development of the Draft Updated Code and Map as potential concerns for stakeholders or staff. These may address examples of institutional growth, commercial development/redevelopment, and residential property development, for each showing the possible development scenario under current zoning and that intended by the proposed updated zoning.

Deliverables: PowerPoint presentation, web and media communication as needed

Meetings: 1 City Work Group and Staff meeting; other meetings with Staff as needed

Task 9: Under the Revised Draft Updated Zoning Code and Map task, all feedback from meetings and public communication under Tasks 6 through 8 are incorporated as appropriate into revised documents to be presented for public presentation and response. This may be facilitated with several days of public workshops with members of specific stakeholder or community groups, to be determined in the course of prior task work.

Deliverables: Electronic and paper Updated Zoning Code, Map, and Equivalency Chart, PowerPoint presentation, web and media communication materials

Meetings: 1 City Work Group and Staff meeting; 1 Charrette or series of public workshops; other meetings with Staff as needed

Task 10: The Final Presentation completes Phase 2, as well as kicks off the adoption process and the finalization of documents in response to public input received on the Draft Updated Zoning Code and Map. A presentation to the City's Planning and Zoning Board will be followed by revisions and presentation to the City Commission.

Deliverables: Electronic and paper Updated Zoning Code, Map and Equivalency Chart, PowerPoint Presentation, web and media communication materials

Meetings: 1 City Work Group and Staff meeting to prepare for public meetings; 1 Planning and Zoning Board meeting; 1 City Commission meeting; Staff meetings

Miami 21: Sample page from Zoning Code

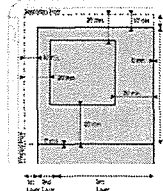
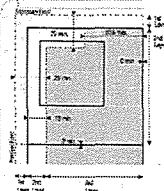
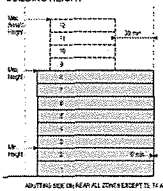
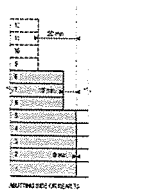
MIAMI 21		ARTICLE 5. SPECIFIC TO ZONES	
AS ADOPTED - OCTOBER 2009		5.6 URBAN CORE TRANSECT ZONES T6-8	
BUILDING DISPOSITION		BUILDING PLACEMENT	PARKING PLACEMENT
LOT OCCUPATION			
a. Lot Area	5,000 s.f. min.; 40,000 s.f. max.	BUILDING HEIGHT	
b. Lot Width	50 ft. min.		
c. Lot Coverage	-1.8 Stories 20% max. 15,000 sq. ft. max. Floorplate for Residential & Lodging 30,000 sq. ft. max. Floorplate for Office & Commercial	BUILDING CONFIGURATION	
d. Floor Lot Ratio (FLR)	57.25% additional Public Benefit	FRONTAGE	
e. Frontage at Front Setback	70% min.	a. Common Lanes	prohibited
f. Open Space Requirements	10% Lot Area min.	b. Fences & Fences	prohibited
g. Density	150 du/acre max. *	c. Temp or L.C.	prohibited
		d. Forecourt	permitted
		e. Shop	permitted
		f. Signage	permitted (T6 & L & T6 & O only)
		g. Gallery	permitted by Special Area Plan
		h. Arcade	permitted by Special Area Plan
BUILDING SETBACK		BUILDING HEIGHT	
a. Principal Front	10 ft. min.; 20 ft. min. above 8 th Story	a. Min. Height	2 Stories
b. Secondary Front	10 ft. min.; 20 ft. min. above 8 th Story	b. Max. Height	3 Stories
c. Side	0 ft. min.; 30 ft. min. above 8 th Story	c. Max. Bay/Block Height	4 Stories Abutting all Trained Zones except T3
d. Rear	0 ft. min.; 30 ft. min. above 8 th Story		
e. Abutting Side or Rear T5	0 ft. min., 1 st through 5 th Story 10 ft. min., 6 th through 8 th Story 30 ft. min. above 8 th Story		
Abutting Side or Rear T4	0 ft. min., 1 st through 5 th Story 25 ft. min. above 5 th Story		
Abutting Side or Rear T3	10% of Lot depth min., 1 st through 2 nd Story 25 ft. min., 3 rd through 5 th Story 45 ft. min. above 5 th Story		

Miami 21: The Permitting process is also simplified from the prior code and is clearly outlined

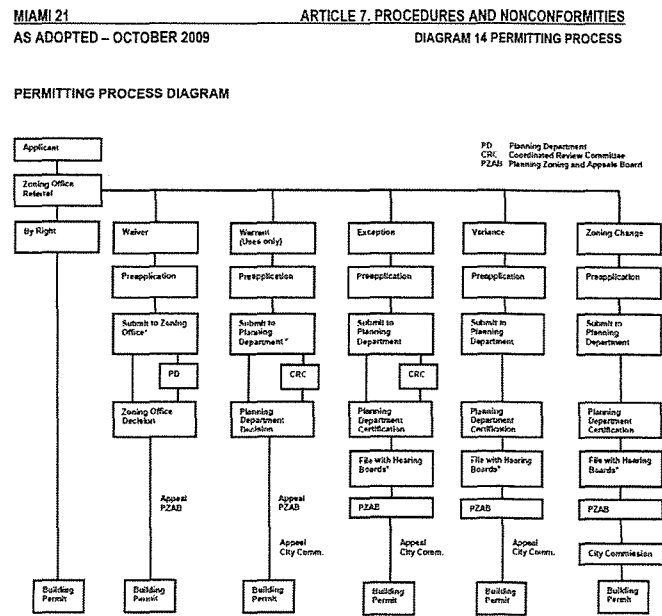

III. PROJECT UNDERSTANDING, PROPOSED APPROACH, AND METHODOLOGY

and support as needed to respond to questions and incorporate revisions

PHASE 3 – ADOPTION PROCESS

Task 11: Technical Support comprises the provision of technical support from the DPZ team to City Staff during the Adoption Process

Deliverables: Responses to on-going questions and comments, advice on potential changes and adjustments, written and graphic documentation for public communication.

Meetings: 1 City Work Group and Staff meeting; other Staff meetings as needed

Task 12: Presentation Aids and Graphics are prepared as needed for the Staff during the Adoption Process.

Deliverables: Text and graphic paper and electronic documents, PowerPoint presentations, web and media communication materials as needed

Meetings: With Staff, as needed

Task 13: Public Meetings as potentially needed are included in the Work Plan.

PHASE 4 – IMPLEMENTATION

Task 14: Training Sessions shall be undertaken to provide instruction on the use of the Updated Zoning

(Below) Images of various meeting types from the Miami 21 planning process



(Left) Implementation Tools: These images from the Sprawl Repair Manual depict the urban transformation of conventional development types, here a commercial strip center and a corner gas station. With intelligent redevelopment techniques, these suburban building types can easily be modified and infilled to create additional real estate opportunities. These new spaces repair car-dominated domains, create more pedestrian friendly building frontages and spaces, and allow for growth while preserving open space and historic neighborhoods.

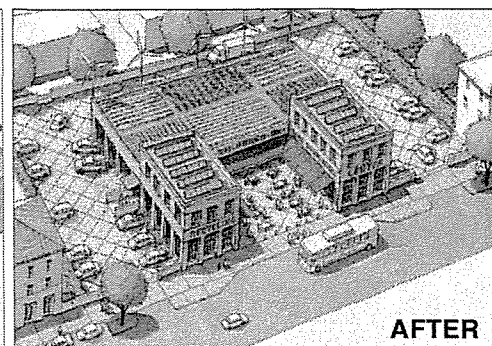
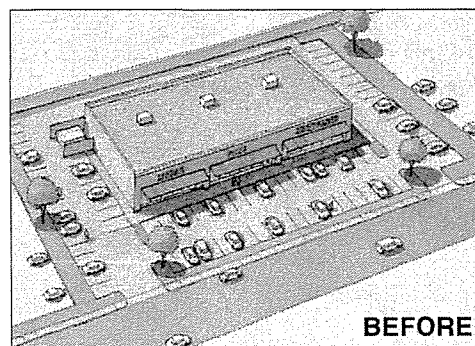
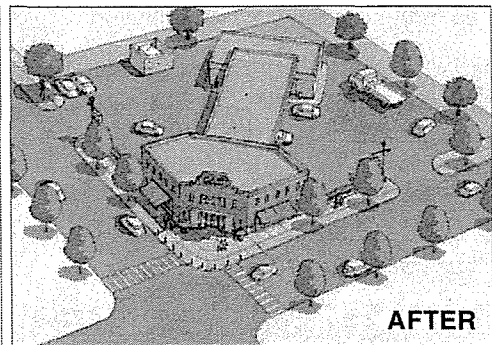
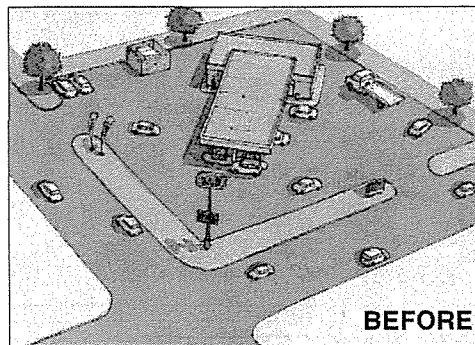

III. PROJECT UNDERSTANDING, PROPOSED APPROACH, AND METHODOLOGY

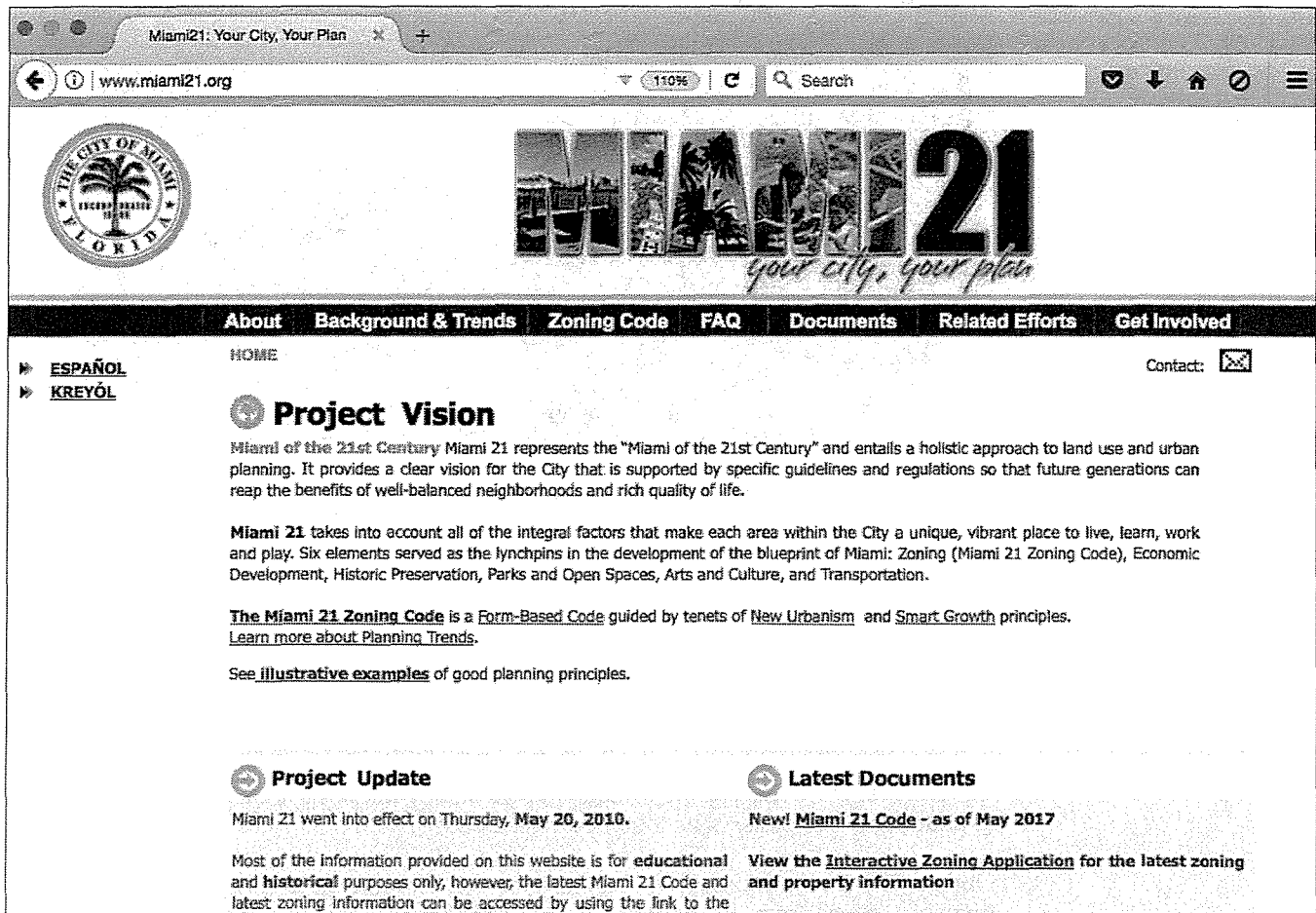

Code and Map to City officials and Staff, professionals, residents, civic associations and other stakeholders; the number and frequency of these are to be determined.

Meetings: 1 Work Group and Staff meeting; 3 Staff meetings; 1 public session

Task 15: A Guidebook and Handouts of the Updated Zoning Code and Map shall be prepared in both electronic and hard-copy formats for ongoing use by City Officials and Staff.

Deliverables: Text and graphic paper and electronic documents, web and communication media materials

Meetings: Staff meetings as needed

Other Implementation Tools:

(Above) The Miami21 website, regularly updated

(Right) A video tutorial for the Interactive Zoning Application process

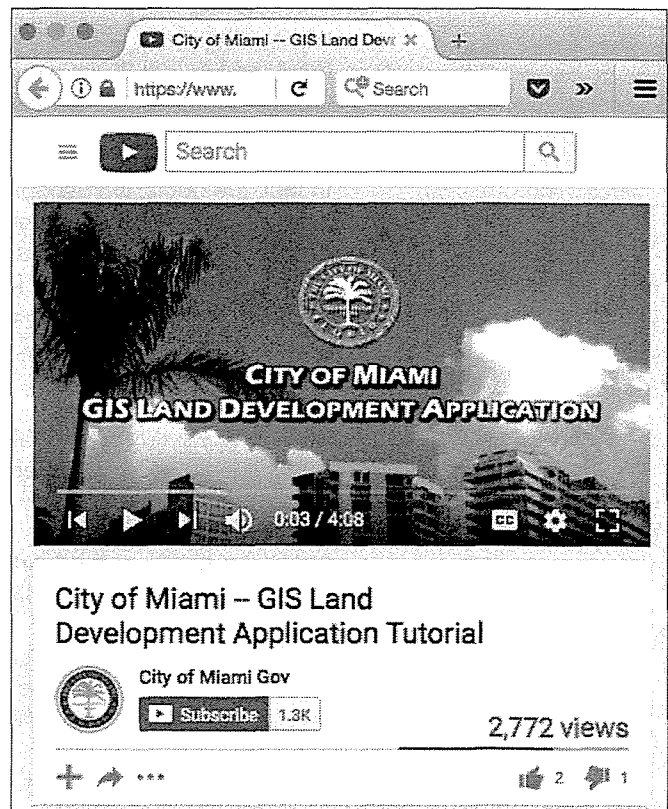

III. RECENT, CURRENT, AND PROJECT WORKLOAD

DPZ Managing Partner Galina Tachieva leads the charrette for Reinvent Phoenix

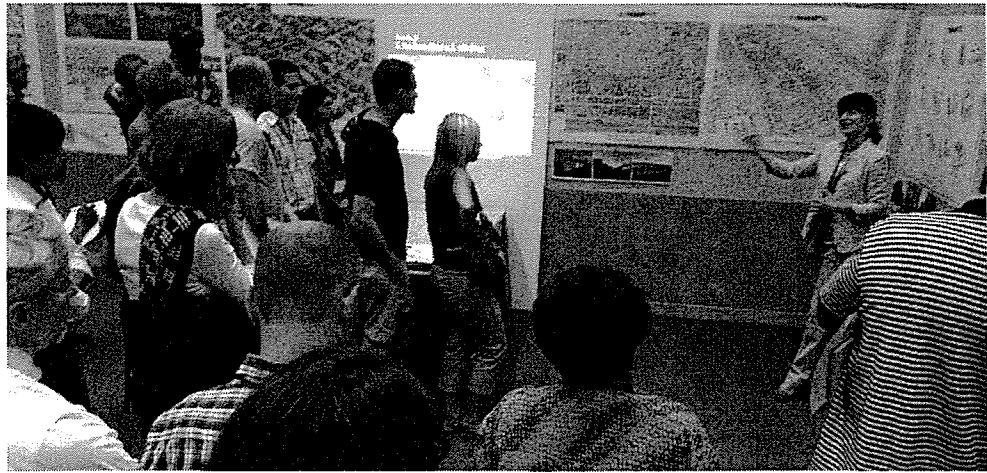

DPZ believes that its recent, current, and projected workload will not interfere with our ability to undertake the scope of work contemplated herein in a professional, diligent, and timely manner.

DPZ has chosen to remain a small firm in order to maintain complete control over quality of our work. With the continued success of our projects, we have fairly consistently received more offers of employment than our 26-person firm can handle, and we have responded by selecting only those projects that best exemplify our professional objectives. We only respond to RFQs and RFPs when we believe that there exists an opportunity for us to make a significant contribution and an opportunity for us to learn as well as to teach. In this manner, we maintain a steady workload, alongside the capacity to undertake new projects as the opportunities arise.

Our confidence in maintaining this balance among current and anticipated project demands stems from our experience with other similar projects, and from an office methodology which is geared to providing a high level of service to a limited client base. When DPZ chooses to work on a specific project, we dedicate the majority of our resources to that project in anticipation of finishing it quickly. We typically take on only one major new planning/design project each month, and most of the significant work is completed during the intense, time-efficient Charrette.

In fact, the public workshop/design Charrette is the most significant factor in our timely provision of services. Under this methodology, the DPZ team sets up an office on or near the project site and leads a collaborative design process that is intended to incorporate the contributions of local government, consultants, and the public at large with the entire design team committed to the project one hundred percent over the course of each workshop. All DPZ team members identified in this proposal are available to work on this study.

Many of our clients, especially municipal governments, agree that our workshops/Charrettes are a much more effective, efficient and inexpensive way to produce a successful plan and code. Further, few clients wish to avoid the considerable publicity which each workshop/charrette typically generates. Our municipal clients are especially enthusiastic about the ability of the workshop/Charrette to bring together disparate governmental bodies and community decision-makers that are not accustomed to acting collectively.

In addition, DPZ always operates as a "virtual firm," collaborating with affiliate firms from our large network of professionals, apart from the local municipal staff in the various places we work. These affiliates, here in the form of Street Plans and EAC, provide valuable assistance to the team in terms of assessments and preparation of proposals vis-a-vis the local development context.

IV. PAST PERFORMANCE AND REFERENCES

DPZ: REINVENT PHOENIX

Type: Phoenix, Arizona
Client Name: Zoning Code, TOD/Corridor Master Plans
Client Address: City of Phoenix, Planning & Development
 200 Washington St, Phoenix, AZ 85003
Contact Name: Curt Upton, City of Denver
 formerly City of Phoenix Planning and Development
Contact Telephone Number: 720 865 2942
Contact Email Address: curt.upton@denvergov.org
Start-End Dates: 2013-2014
Contract Amount: Approx. \$1,100,000
Services Provided:

Reinvent Phoenix represents a new vision for a more livable and equitable development future in the five TOD districts along the existing Metro light rail corridor. The effort is funded by a U.S. Department of Housing and Urban Development Community Challenge Grant from the Office of Sustainable Housing and Communities. DPZ completed the design, coding, and implementation plan for Reinvent Phoenix during a series of three charrettes, where the design team worked closely with local steering committees, the public, the City of Phoenix Planning and Development Department and other departments, agencies and organizations, as well as the City's partners, Arizona State University (ASU), and St. Luke's Health Initiative.

As the prime consultants, DPZ led a large team of sub-consultants with national and local resources and talent, in the areas of coding, civil and traffic engineering, community development, sustainability, marketing and neighborhood outreach, retail development, and local academic research.

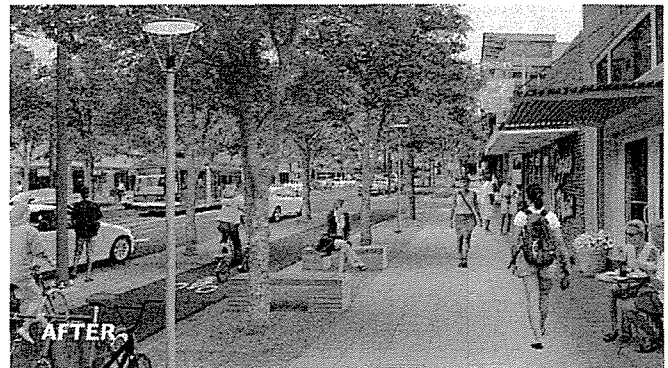

The photo and rendering above show a main thoroughfare with the addition of light rail and numerous streetscape improvements, including on-street parking, planted medians, a protected bike lane, storefront improvements, and wider sidewalks with seating areas. Below are excerpts from the new code.

SECTION 1303: TRANSECT ZONING DISTRICTS **CHAPTER 13**
City of Phoenix, AZ

TABLE 1303.02 (C) - BUILDING SETBACKS AND LOT REQUIREMENTS

BUILDING SETBACKS AND LOT REQUIREMENTS	
FRONT SETBACK	Minimum: 5 feet
REAR SETBACK	Minimum: 5 feet
SIDE SETBACK	Minimum: 5 feet
MINIMUM LOT AREA	Minimum: 10,000 sq. ft.
MINIMUM LOT WIDTH	Minimum: 100 feet
MINIMUM LOT DEPTH	Minimum: 100 feet

TABLE 1303.03 (C) - BUILDING HEIGHTS

Building Type	Maximum Height
Single-Family Detached	35 feet
Single-Family Attached	35 feet
Multi-Family Residential	45 feet
Commercial	60 feet
Industrial	45 feet

CHAPTER 13 **SECTION 1306: FRONTAGE STANDARDS**
City of Phoenix, AZ

TABLE 1306.01 - FRONTAGE SETBACK TYPES

Setback Type	Requirements
Setback Type - Building	Minimum setback of 5 feet from the street line. Maximum setback of 10 feet from the street line. Minimum setback of 5 feet from the street line. Minimum setback of 5 feet from the street line.
Setback Type - Sidewalk	Minimum setback of 5 feet from the street line. Maximum setback of 10 feet from the street line. Minimum setback of 5 feet from the street line. Minimum setback of 5 feet from the street line.

SECTION 1309: SIGNAGE STANDARDS **CHAPTER 13**
City of Phoenix, AZ

TABLE 1309.01 - SIGNAGE HEIGHT REGULATIONS

Signage Type	Maximum Height
Billboard	60 feet
Signage	45 feet
Signage	45 feet
Signage	45 feet

IV. PAST PERFORMANCE AND REFERENCES

DPZ: ORANGE COUNTY CODE Orange County, Florida
 Type: Zoning Code
 Client Name: Orange County, Florida
 Client Address: 2450 W 33rd ST, 2nd Floor, Orlando, FL 32839
 Contact Name: Susan McCune, AICP
 Planning Division - Community, Environmental,
 and Development Services
 Contact Telephone Number: 407 836 0952
 Contact Email Address: Susan.McCune@ocfl.net
 Start-End Dates: 2016-Present
 Contract Amount: \$460,000

Services Provided:

Canin Associates and DPZ have been engaged by Orange County Florida to prepare comprehensive updates to the County's Land Development Code. The scope of work comprises five broad tasks – Task 1: General Assessment; Task 2: Market Area Analysis; Task 3: Public Engagement; Task 4: Targeted Market Areas Code Development; and Task 5: County-wide Code Development – and is anticipated to be completed in three years.

Specific deliverables include but are not limited to:

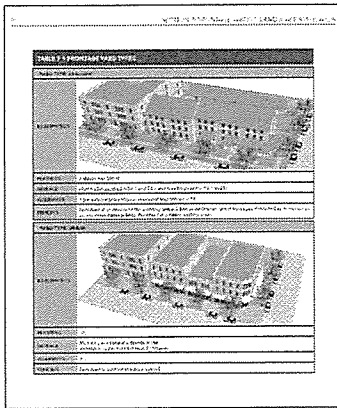
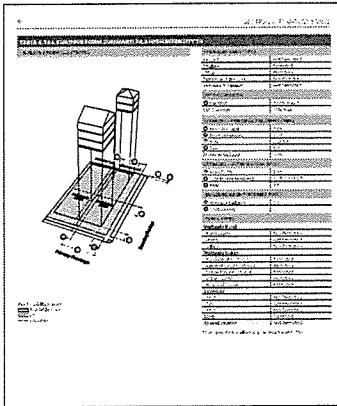

- **Code Modules.** The code update shall regulate development to ensure high-quality public spaces by context-sensitive building types and uses. It shall incorporate building form standards, street standards, (plan and cross-section), use regulations, descriptive building or lot types, regulating plan requirements, and other elements needed to implement the development strategies for transit oriented development (TOD) and greenfield development.
- **Zoning Atlas.** The Zoning Atlas will be the new zoning document for Orange County. However, to fully implement the vision, further studies such as the calibration of specific Place Types plans with local public involvement will be required after the adoption of the code which will result in further map amendments.
- **Transect Zone Standards.** The preparation of the Standards include the development of the major design parameters associated with site and building requirements. These standards govern basic building form, placement, and fundamental urban elements to ensure that all buildings complement neighboring structures and the street. Development regulations may include building form standards such as “build-to-lines” or “required building lines” and building type or form designations.
- **Subdivision (/Place Type) Standards.** The preparation of these standards includes revisions to or replacement of the current Subdivision standards, and may include the development of land development standards categorized by Place Type such as location and types of open spaces permitted, permitted roadway types, maximum block sizes, and other standards that are most appropriately addressed at the scale of the pedestrian shed.
- **Other Major Standards** include those for signage, streets, landscape, and open space that may be integrated into multiple transect zones or Place Types as appropriate, and will be developed in detail after the primary transect-based standards are largely complete. Public space/street standards define design attributes and geometries that balance the needs of motorists, pedestrians, bicyclists, and transit riders while promoting a vital public realm. These standards shall include design specifications for sidewalks, travel lane widths, parking, curb geometry, trees, lighting, etc.
- **Development Regulations** for areas within the urban service area and rural settlement areas, as well as in greenfield development areas may include: maximum block sizes to enhance interconnectivity and walkability; public space types (such as greens, squares, and parks); and other special features.

IV. PAST PERFORMANCE AND REFERENCES

DPZ: WEST HAVEN TOD AND FORM-BASED CODE West Haven, Connecticut

Type: TOD and Zoning Code
 Client Name: City of West Haven, Connecticut
 Client Address: 200 Washington St, Phoenix, AZ 85003
 Contact Name: Joe Riccio, Commissioner
 Department of Planning and Development

Contact Telephone Number: 203 937 3580
 Contact Email Address: jriccio@westhaven-ct.gov
 Start-End Dates: 2014-2016
 Contract Amount: Approx. \$200,200
 Services Provided:

In the summer of 2013, the City of West Haven opened the state-of-the-art West Haven passenger station. Working with the momentum of the new station and with great support of the state government, the City of West Haven identified 130 acres for a Transit-Oriented Development vision plan as well as an updated code to ease its implementation.

Hired by the City in 2014, the DPZ team looked at three levels of intervention, considering underlying land ownership carefully: a lean vision, with infill and other minimal intervention strategies; a short-term vision, which includes smaller incremental development; and a longer-term vision with redevelopment that can accommodate significant population growth. All three plans prioritize retrofit and adaptive re-use; preserve a combination of housing, commercial, and light industrial uses; identify specific parcels in need of sprawl repair; suggest street modifications that accommodate all modes of circulation; and look to the larger urban area, connecting the TOD area to West Haven's historic Main Street. Given the importance of this transportation node and the proposed higher densities and mixed-use building types, a code was prepared to facilitate and incentivize the right kind of development.

Currently, the project is moving towards implementation, inspiring other cities along the Connecticut rail lines to follow suit.

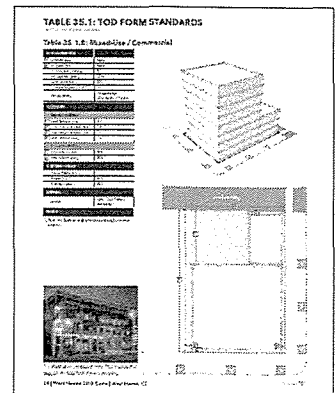
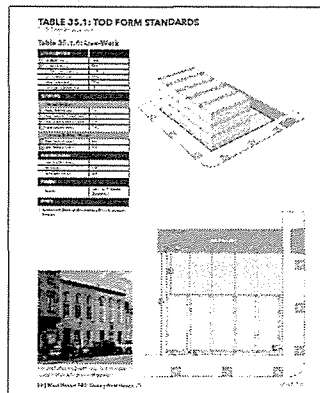
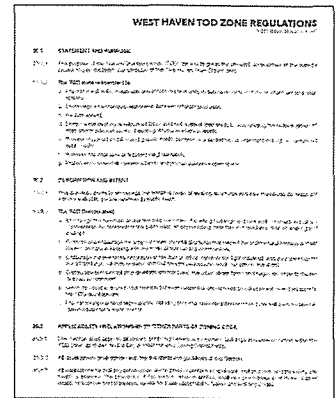
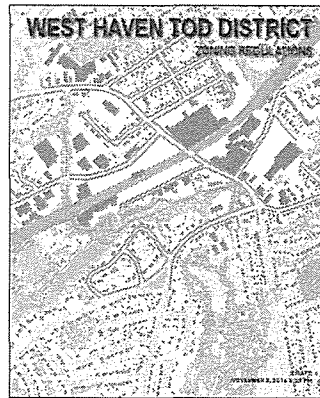

IV. PAST PERFORMANCE AND REFERENCES

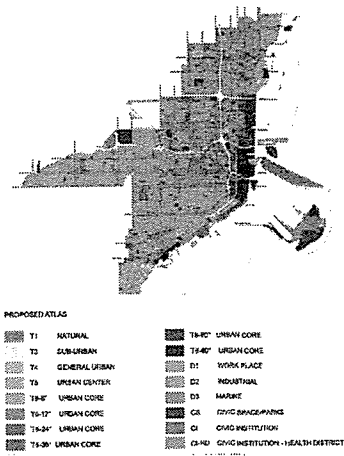

Miami 21 Zoning Atlas

DPZ: MIAMI21

Type:
Client Name:
Client Address:
Contact Name:

Miami, Florida
Zoning Code Update
City of Miami, Florida
444 SW 2nd Avenue, Miami, FL 33130
Manny Diaz
former Mayor of Miami
305 416 3180
manny@lydeckerdiaz.com
2014-2010
Approx. \$2,000,000

Contact Telephone Number:
Contact Email Address:
Start-End Dates:
Contract Amount:
Services Provided:

DPZ led the preparation of Miami21 – a form-based zoning code that replaced Miami's FAR and land use-based regulations. Using the Transect and the SmartCode as its basis, the new code focuses on the control of building to assure pedestrian-oriented public space, and provide physical predictability for developers and residents alike. Multiple use and density types are consolidated, and the translation from FAR to FLR (floor lot ratio, that includes parking) simplifies building capacity measure and reduces parking. A public benefits program encourages the provision of affordable housing, public open space, and historic preservation.

2011 APA National Planning Excellence Award for Best Practice
2010 Driehaus Form-Based Code Award
Paul Crawford Distinction for a Ground-Breaking Code
APA FL 2010 Award of Excellence, Best Practices Category

While Miami21 was completed 7 years ago, two years over the 5-year cut-off stipulated in the RFP, we nonetheless have included it herein as a relevant project, and Mayor Manny Diaz as a key reference, given the core significance and success of the undertaking.

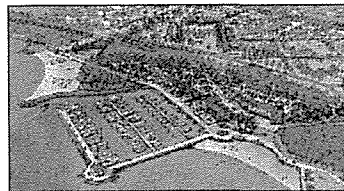

STREET PLANS: HIGHWAY 200 MASTER PLAN AND CODE

Type:
Client Name:
Client Address:
Contact Name:

Ponderay, Idaho
Sub-Area Plan and Zoning Code
City of Ponderay, Idaho
288 Fourth Street, Ponderay, ID 83852
Erik Brubaker
Planning Director
208 265 5468
planner@ponderay.org
2014-2017
Approx. \$150,000

Contact Telephone Number:
Contact Email Address:
Start-End Dates:
Contract Amount:
Services Provided:

Street Plans created a regulating plan and code for Highway 200 and the Pend D'Oreille Lakeside. The Code includes new zoning district regulations that will transition existing suburban land use patterns into compact walkable land use patterns by using an incremental approach to development.

To kick off the planning process, Street Plans visited Ponderay to observe and document existing conditions and interview stakeholders. The planning process included a robust public outreach and engagement strategy, comprised first of a design charrette. This charrette was followed by multiple public meetings. While the end result included new land development regulations, the public process also included discussions of alternatives for street design, street connectivity, and town planning strategies that create vital town centers, corridors, and livable neighborhoods. The form-based code presents a new future of land development for Ponderay, and builds off of the existing urbanism present in Ponderay.

IV. PROPOSER'S PREVIOUS CONTRACTS WITH THE CITY OF CORAL GABLES

DPZ's Elizabeth Plater-Zyberk, on an individual basis or via the University of Miami School of Architecture (UMSoA) where she was formerly the Dean and today continues to teach, has served as a consultant to the City of Coral Gables Planning and Zoning Division on various small planning efforts. Among these consultations are: as a contracted consultant on the North Ponce Community Visioning Workshop in 2015; as a volunteer advising the City on potential zoning revisions pertaining to housing; as an intermittent peer reviewer on development proposals for the Holiday Inn and Mediterranean Village/Ponce Circle sites in 2014, via the UMSoA; and as among the lead planners for the Coral Gables Master Plan in 2002, also via the UM SoA and the Knight Program in Community Building.

Street Plans worked on the Coral Gables Bicycle and Pedestrian Master Plan from 2012 to 2013. In collaboration with Stantec, Street Plans conducted a study that identified short term phase projects that could be implemented with the initial \$400,000 investment that was voted on by the City Commission in 2010. The historic decision to invest in the expansion of bicycle facilities around the city was a positive move towards a more walkable and bikeable Coral Gables. Simultaneously, the city also embarked on an ambitious public works campaign to repave city streets and implement traffic calming projects around the city, which it is currently underway. Contacts for the City of Coral Gables during the awarded contract were Ernesto Pino, Assistant Public Works Director and Sonia Succar, Environmental Manager.

Besides the short term phase recommendations, Street Plans also identified bicycle and pedestrian investments that could be made in the years ahead. For this initial investment, this study recommended the implementation of a bike lane along the most heavily used route in the city, from Salzedo in the downtown core, to University Drive, straight to the University of Miami Campus. Over the long term phase, the proposed Coral Gables Bicycle/Pedestrian Plan envisioned more than 27 miles of new or improved bikeways, sidewalks and crosswalks with a focus on inexpensive and practical projects. In 2012, the City of Coral Gables Bicycle network included 9.1 miles of Bicycle Lanes, Shared Use Paths, and Greenways. Thus, this plan recommended a comprehensive expansion and diversification of facilities to expand the demographic of residents who bicycle.

Last but not least, EAC successfully negotiated a Professional Services Agreement on June 10, 2016 with the City of Coral Gables to provide General Engineering Consulting Services to the City for a two (2) year period which may be extended for one (1) additional two (2) year period.

The purpose of the Contract is to provide the City with planning and general civil design services, paving and drainage assessment and design, surveying, mechanical, electrical, plumbing and HVAC assessment and design, structural analysis and design, construction management and contract administration, construction engineering and inspection services, bridges (structural design and inspections), and cost estimating.

The City's Contract Administrator for EAC's engagement above is Ed Santamaria, Director of Public Works Department.

IV. PUBLIC SECTOR CLIENTS THAT HAVE DISCONTINUED USE OF PROPOSER'S SERVICES

DPZ's services have never been discontinued by any of its public sector clients within the past two years.

Street Plans' services have never been discontinued by any of its public sector clients within the past two years.

EAC's services have never been discontinued by any of its public sector clients within the past two years.

To complete a planning effort with the scope of services as described in this RFP response document, DPZ's price proposal comprises **US Dollars Three Hundred Five Thousand and Seven Hundred Ninety (\$305,790.00)**, comprising \$290,790.00 in professional services and \$15,000.00 in (reimbursable) expenses. The full Pricing Form is provided on page 63, showing the estimated number of team members, number of hours, and unit cost average, and sub-total fees by task.

The team's price proposal does not include fees and/or expenses for other third-party consultants directly engaged by the City of Coral Gables.

The DPZ team's anticipated expenses comprise the following items, as incurred in our service to the City of Coral Gables:

- Cost of round-trip travel for DPZ team members who are non-South Florida residents, as required (economy class), and other ground transportation (i.e. Uber/Lyft, taxis) as required;
- Cost of local accommodations and meals for the DPZ team, as required;
- The cost of expendable drafting/drawing supplies (e.g. pencils, pens, paper, other Charrette studio supplies, etc.) the DPZ team requires at the Charrettes; and
- Estimated reprographics costs (for printing of reports), and shipping/transmittal.

Meanwhile, we have assumed that the City of Coral Gables is able to provide a suitable Charrette studio space, as well as the necessary studio furniture, equipment, and other technical requirements and local logistics (e.g. Internet), per the DPZ team's specifications and at no cost to the DPZ team.

Additional deliverables that are one-time and/or finite products, such as the production of a Project video, and/or other additional marketing-quality project material apart from those described in this proposal document, are to be priced on a case-by-case, hourly or lump sum basis; the cost for these are not included in our price proposal.

The full Pricing Form table provided on page 63 has been altered as allowed by the RFP; as the sample table provided in the RFP does not account for differing hourly rates among various project team members, what is shown herein is a rate that is averaged from the subtotal fee per task divided by the subtotal number of hours per task. This accounts for the varying average hourly rates shown in the table.

The Section 8 signature page from the RFP is provided on the next page.

We would be happy to discuss with the City this price proposal vis-a-vis the proposed scope should our team be selected to undertake the work.

SECTION 8

Request for Proposal (RFP) No 2017.05.MS

8.0: PROPOSAL PRICING

Each Proposer shall ensure the Proposal Pricing Schedule listed below is completed in full, with Proposer providing a detailed list of all costs to provide Services.

Proposer shall submit a Proposal expressing its interest in providing the services described herein. To receive consideration, this Request for Proposal must be submitted in its entirety, with all forms executed. All corrections to prices made by the Proposer must be initialed. Any additional information to be submitted as part of the Proposal may be attached behind the Proposal Pricing Schedule, carefully cross-referencing each item number and/or letter.

The City reserves the right to add or delete any service, at any time. Should the City determine to add an additional service for which pricing was not previously secured; the City shall seek the Successful Proposer to provide reasonable cost(s) for same. Should the City determine the pricing unreasonable, the City reserves the right to negotiate cost(s) or seek another vendor for the provision of said service(s).

8.1. Pricing Form

Please complete the following table, which may be altered to clearly reflect all relevant information to derive the total cost to provide all services as described in this solicitation.

Tasks	No. of Team Members	No. of Hours	Unit Cost:	Total:
Project Management				
Preliminary Tasks				
Public Participation Process				
Zoning Code Amendments				
Adoption Process				
Travel Expenses				
Materials & Supplies				
Other				
Total				

Please refer to the full/completed Pricing Form on the facing page.

Proposer: DPZ PARTNERS, LLC dba DPZ CoDESIGN Address 1023 SW 25th AVENUE, MIAMI, FLORIDA 33135

Contact Name SENEN M. A. ANTONIO Title PARTNER Signature 

Telephone 305 644 1023 Email: SENEN@DPZ.COM

Balance of Page Intentionally Left Blank

**CITY OF CORAL GABLES
PLANNING SERVICES FOR ZONING CODE UPDATE
PROPOSAL PRICING SCHEDULE - PRICING FORM**

TASKS	DPZ CoDESIGN				THE STREET PLANS COLLABORATIVE				EAC CONSULTING				TOTAL (\$)
	No. of Team Members	No. of Hours	Unit Cost Average (\$/Hour)	Sub-Total (\$)	No. of Team Members	No. of Hours	Unit Cost Average (\$/Hour)	Sub-Total (\$)	No. of Team Members	No. of Hours	Unit Cost Average (\$/Hour)	Sub-Total (\$)	
PHASE 1 ASSESSMENT AND ANALYSIS (MONTHS 1 - 3)													
Task 1 Project Start-up	3	40	170.00	\$6,800	0	0	0.00	\$0	0	0	0.00	\$0	\$6,800
Task 2 Interactive Analysis of Project Background Materials	4	140	128.57	\$18,000	3	40	160.00	\$6,400	2	60	190.00	\$11,400	\$35,800
Task 3 Draft Assessment and Analysis	6	174	135.06	\$23,500	3	20	157.00	\$3,140	2	60	190.00	\$11,400	\$38,040
Task 4 Final Assessment and Analysis	6	154	133.12	\$20,500	3	20	157.00	\$3,140	2	30	190.00	\$5,700	\$29,340
Task 5 Revisions to the Project Schedule and Other Adjustments	2	14	214.29	\$3,000	0	0	0.00	\$0	0	0	0.00	\$0	\$3,000
Sub-Total		522		\$71,800		80		\$12,680		150		\$28,500	\$112,980
PHASE 2 DRAFT UPDATED ZONING CODE (MONTHS 4 - 9)													
Task 6 Draft Updated Zoning Code Development	8	240	147.50	\$35,400	4	40	136.75	\$5,470	0	0	0.00	\$0	\$40,870
Task 7 Draft Updated Zoning Map Development	8	240	147.50	\$35,400	4	20	150.00	\$3,000	2	30	190.00	\$5,700	\$44,100
Task 8 Testing of Sample Conditions	6	94	156.38	\$14,700	4	20	150.00	\$3,000	2	16	190.00	\$3,040	\$20,740
Task 9 Revised Draft Updated Zoning Code and Map	5	84	145.24	\$12,200	4	20	150.00	\$3,000	2	24	190.00	\$4,560	\$19,760
Task 10 Final Presentation	3	52	146.15	\$7,600	0	0	0.00	\$0	0	0	0.00	\$0	\$7,600
Sub-Total		710		\$105,300		100		\$14,470		70		\$13,300	\$133,070
PHASE 3 ADOPTION PROCESS (MONTHS 10 - 12)													
Task 11 Technical Support	4	54	148.15	\$8,000	4	20	142.00	\$2,840	2	30	190.00	\$5,700	\$16,540
Task 12 Presentation Aids and Graphics	4	52	146.15	\$7,600	0	0	0.00	\$0	0	0	0.00	\$0	\$7,600
Task 13 Public Meetings	2	14	214.29	\$3,000	0	0	0.00	\$0	0	0	0.00	\$0	\$3,000
Sub-Total		120		\$18,600		20		\$2,840		30		\$5,700	\$27,140
Phase 4 Implementation (Months 13 - 15)													
Task 14 Training Sessions	4	64	156.25	\$10,000	0	0	0.00	\$0	0	0	0.00	\$0	\$10,000
Task 15 Guidebook and Handouts	4	52	146.15	\$7,600	0	0	0.00	\$0	0	0	0.00	\$0	\$7,600
Sub-Total		116		\$17,600		0		\$0		0		\$0	\$17,600
Expenses (Travel, Materials, Supplies, and Reprographics)				\$15,000				\$0				\$0	\$15,000
TOTAL		1468		\$228,300		200		\$29,990		250		\$47,500	\$305,790

This page is intentionally blank.