

## CITY OF CORAL GABLES - MEMORANDUM -

**TO:** ARCELI REDILA  
CITY PLANNER

**DATE:** MARCH 4, 2020

**FROM:** PAUL RODAS, P.E.

**SUBJECT:** 250 BIRD RD. TENTATIVE PLAT

---

As per Zoning Code Article 3, "Development Review", Division 9, "Platting/Subdivision", the Public Works Department is required to review and comment on all proposed tentative plats. Public Works has reviewed the 250 Bird Road tentative plat in accordance to the re-plat requirements specified in Zone Code Article 5, "Development Standards", Division 15 "Platting Standards and have the following comments:

1. *The City of Coral Gables Public Works Department does not object to the re-platting of the subject property. The Department's Surveyor review revealed that the submitted plans and field work meet the minimum technical standards set forth by the Florida Board of Land Surveyors.*
2. *The proposed tentative plat shall be submitted to Miami-Dade County Transportation and Public Works Department and Miami-Dade County for review and approval, prior to consideration as final plat by the City Commission.*
3. *Utility easements by deed reservation along the side and rear lines of platted lots (a.k.a. Merrick Easements) are to be vacated via Resolution by the City Commission of Coral Gables.*
4. *The relocation of existing utilities from alley previously vacated by Ordinance 2015-08, including but not limited to sanitary sewer, FPL, communication and telephone, shall be completed prior to Final Plat approval.*
5. *The demolition of all existing improvements except the existing building noted to remain in the tentative plat shall be completed prior to Final Plat approval.*
6. *The existing building that is scheduled to remain has certain encroachments into the Salzedo Street and Bird Road rights-of-way as noted in the tentative plat. Encroachment covenants shall be approved by the City Commission and executed prior to Final Plat approval.*

Additional comments that were part of the Development Review Committee process:

- Additional connection fees will be assessed relative to the proposed sewer flows in accordance with an existing sewer agreement to reimburse previously constructed sanitary sewer system improvements. Additional sewer system improvements may be required including but not limited to the lining of existing sewer lines and manholes abutting the property as necessary.
- Right-of-way improvements to include new curb & gutter, landscaping, bike parking, covered bus stop, paving and drainage improvements, etc. will be required along adjacent streets. Improvements along Bird Road to be coordinated with FDOT's corridor plan. FDOT approval of those improvements will be required.
- Streetscape improvements will be required in accordance with the City of Coral Gables streetscape master plan.

## Attachment C

- Lighting improvements might be required subject to a photometric analysis. All new lighting in the ROW shall be LED, 3000k, Coral Gables pole with acorn fixture. You may request additional specifications from the department.
- Sight triangles shall be maintained at all intersections and driveway approaches.
- Restrictive covenants must be executed for all non-standard improvements and all encroachments in the public Right of Way. Encroachments along Bird Road require coordinate with FDOT.

For a full list of comments provided under the Development Review Committee and Planning and Zoning Board processes, please contact Development Services at 305-460-5245. Their offices are located at 405 Biltmore Way. For any questions or comments on the Public Works comments, please feel ~~free~~ to contact my office at (305)460-5048.



Sincerely,

Paul Rodas, P.E.  
Permit Section Manager  
City of Coral Gables  
Department of Public Works  
2800 SW 72nd Avenue  
Miami, FL 33155  
T: 305.460.5048

cc: Ramon Trias, Assistant Director for Planning  
Hermes Diaz, P.E., Public Works Director  
Jorge Gomez, P.E., Public Works Deputy Director/City Engineer  
Jessica Keller, Public Works Assistant Director  
Juan Martinez, PSM, Public Works Surveyor

**CITY OF CORAL GABLES**

**- MEMORANDUM -**

**TO:** ARCELI REDILA  
PRINCIPAL PLANNER

**DATE:** JULY 13, 2020

**FROM:** MELISSA DEZAYAS, P.E.  
SR MULTIMODAL TRANSPORTATION ENGINEER

**SUBJECT:** 250 Merrick

---

**Proposed Development:** 250 Merrick – Mixed-Use Building

**Contents of Development:** 11-story mixed-use building with residential (215 units), retail (11,840 SF), and office (22,591 SF) uses plus parking garage

**Proposed Location:** 250 Bird Road, Coral Gables, Florida

---

**Resolution**

A traffic study for the 250 Merrick located at 250 Bird Road was submitted by A&P Consulting Transportation Engineers (APCTE) on February 27, 2020. The City had David Plummer and Associates (DPA) review the first submitted traffic study, and comments were provided on April 9, 2020. APCTE responded to these comments on April 21, 2020, without resubmitting a revised traffic study. DPA provided a second round of review comments on May 12, 2020. APCTE provided a final revised traffic study addressing all of DPA's comments on May 29, 2020. DPA confirmed that all comments had been resolved on June 1, 2020.

The City of Coral Gables Public Works Department also reviewed the information, comments provided by both consultants, and revised traffic study. Based on the City's review, the traffic study for the proposed development at 250 Bird Road meets the requirements stated within City of Coral Gables *Ordinance 2018-09* and applicable TIS Standards.

Should there be any changes or questions, please contact the Project Manager, Melissa DeZayas at [mdezayas@coralgables.com](mailto:mdezayas@coralgables.com)

## RESPONSE TO COMMENTS

**FROM:** Dima Poe, P.E.

**TO:** Melissa DeZayas, P.E.

**CC:** Juan Espinosa, P.E.

**STUDY:** TWO #01 250 Merrick Mixed Used Building Traffic Impact Study

**STUDY PERFORMED BY:** A&P Consulting Transportation Engineers

**DATE OF REPORT:** February 27, 2020 (Date of 1<sup>st</sup> Review Response to Comments: April 21, 2020)

**STUDY REVIEWED BY:** David Plummer & Associates, Dated April 9, 2020 (1<sup>st</sup> Review), May 12, 2020 (2<sup>nd</sup> Review)

---

Based on the second review of the subject report, please consider the following responses to comments:

1. **Section 1.1** – The project is proposing 10,895 SF of ground floor retail space not 11,840 SF as shown in the description and analysis. Please update text and analysis as appropriate.

**Response:** The plans received from Behar Font (architect) on February 12, 2020 and provided in Appendix A, shows that Retail space will consist of 11,840 SF (6,740+ 1,160 + 3,940) Please note that there is one land use labeled Office/Retail however the distinction between how much of the 6,740 SF would be Office versus Retail was not provided. Additionally, the excess 945 SF was not accounted for in any of the other listed land uses with in the plan sheet (i.e. new proposed office LU). Therefore, in order to assign trips to the total proposed square footage of the building we counted the 945 SF under retail since it was color coded with that land use area.

**DPA Response:** Comment addressed. It should be noted that the site plan has been modified since the start of the traffic study. Although the square footage of the retail/office was reduced the conclusions of the traffic study will remain the same.

**Response 2:** Noted. Since the change to square footage does not alter the conclusions of the study, no change to the report study or analysis will be made regarding the trip generation/distribution or level-of-service and parking analysis. No further action or changes required.

2. **Section 1.1** – The project is proposing 362 parking spaces. All proposed parking spaces will be shared by the residential, office and retail users. Please update text and parking analysis as appropriate. In particular, please update Table 15 to reflect that the project's proposed parking complies with the City's parking requirements pursuant to the shared parking matrix provided in Section 5-1410(B)(2) of the Zoning Code.

**Response:** As per discussion with Behar Font and as shown in the updated plans in Appendix A, the development is proposing a total of 367 parking spaces. We confirmed this number by reviewing each floor plan provided for the parking garage and counting the spaces. The parking spaces for office and retail will be shared. However, from that discussion, it was understood that residential units' parking spaces will not be shared. Likely due to the use/operation of mechanical lifts and tandem parking spaces. This information

was used to conduct the parking requirements analysis using the City's Zoning Code methodology. The required number of parking spots calculated to be 368, with a difference of one space from proposed. However, with all the surround area's on-street (remote) parking, and with 13 street parking spaces directly adjacent to the development, the requirement of one retail/office parking space is offset. The provided parking spaces are sufficient for the land uses proposed under this development.

**DPA Response:** Comment not addressed. As mentioned before, the site plan has been modified since the start of the traffic study. The revised site plan proposes 362 parking spaces. It was confirmed with the developer and the architect that the intent is to have one (1) reserved parking space for each residential unit (215 spaces) and to share the remaining number of spaces between residential, office and retail uses. Please update the parking analysis as appropriate. In particular, please update Table 15 to reflect that the project's proposed parking complies with the City's parking requirements pursuant to the shared parking matrix provided in Section 5-1410(B)(2) of the Zoning Code.

**Response 2:** Agree, we have contacted the Architect again and obtained the updated parking information. The parking analysis will be updated to account for the parking spaces that are to be shared between residential, office and retail uses. We shall adhere to the City's parking requirements provided in Section 5-1410(B)(2) of the Zoning Code.

- 3. Section 2** – Please consider including an exhibit showing the existing lane configuration and signalization at the analyzed intersection. This will help better understand the roadway network adjacent to the development.

**Response:** Agree, we will create a figure showing the existing lane configuration and included it in the report. Signalization, SOP, and timing plans are described in Section 2.3 on Page 10 of the report and provided in Appendix D.

**DPA Response:** Comment addressed.

**Response 2:** Noted. No further action or changes required.

- 4. Figure 2** – San Lorenzo Avenue / Ponce de Leon Boulevard is a T-intersection. Please remove the east leg from the exhibit. This comment also applies to Figures 3, 4 and 5.

**Response:** Agree, the east leg will be removed from the exhibit.

**DPA Response:** Comment addressed.

**Response 2:** Noted. No further action or changes required.

- 5. Table 2** – Filed observations at Asset 6165 described a conflict between the westbound left turn movement and pedestrians crossing the south crosswalk. However, there is no westbound movement at this signalized intersection. Please correct the description or provide additional information.

**Response:** Agree, the description in that cell was incorrectly placed. The table will be revised.

**DPA Response:** Comment addressed.

**Response 2:** Noted. No further action or changes required.

6. **Section 3.2** – Please provide data and calculations that demonstrate that a pass-by reduction was not justified.

**Response:** Using the methodology explained in the Trip Generation Handbook, 3<sup>rd</sup> Edition (Derive a pass-by estimate from national database presented in Appendix E) the most recent data to compute a pass-by reduction dates to 1994, for a 17,000 SF shopping center in Orlando, FL. (ITE LU: 820). The pass-by reduction calculated with this methodology would be 66%. Applying the reduction would have decreased the trips from Retail down to less than 10 trips entering in the PM peak period, and less than 5 trips in the AM peak period. Therefore, to maintain a conservative analysis and a realistic assessment of the number of trips associated with the proposed land uses, pass-by trips were not deducted.

**DPA Response:** Comment addressed. However, it should be noted that is not uncommon for a retail space fronting a major roadway (Bird Road) to attract a high percentage of vehicle trips from traffic already in the system. We agree that by not applying a pass-by deduction, the study provides for a conservative analysis.

**Response 2:** Noted. No further action or changes required.

7. **Section 3.2** – Please explain why ITE Land Use 221- Multifamily Housing (Mid-Rise) was used to estimate the residential trips instead of Land Use 222 Multifamily Housing (High-Rise) since the project has over 10 levels (floors).

**Response:** The plans received from Behar Font show that there are only 10 floors that contain dwelling units; and two of those levels only have four units. Since the Mid-Rise lane use code is used for multifamily buildings between 3 to 10 floors, it is applicable to this development.

**DPA Response:** Comment addressed. Please note that ITE does not define that the floors need to be habitable; it only defines High-rise as a building over 10 floors in general. However, using Mid-rise does provide for a conservative analysis.

**Response 2:** Noted. No further action or changes required.

8. **Section 3.2** – Please explain why a multimodal (other modes of transportation) deduction was not applied to the trip generation analysis. As explained in Section 2.5 of the report, the project is located in an area conducive to pedestrian movement and served by transit.

**Response:** A more conservative analysis was conducted by excluding these modes. The results show no adverse impact due to the new traffic added by the proposed development. As such, including or excluding these modal deductions would not significantly change the LOS results (LOS on the major corridors in the vicinity of the project). The level of service analysis for the future with development condition showed the same intersection approaches at LOS F as without the development. As well as, all intersections and roadway segments operated under the 150% capacity threshold of the roadway, as allowed by the City of Coral Gables in the Comprehensive Plan (Policy MOB-2.1.1 and MOB-2-1.2).

**DPA Response:** Comment addressed. We agree that by not applying a “other modes of transportation” deduction, the study provides for a conservative analysis.

**Response 2:** Noted. No further action or changes required

9. **Table 6** – Please include a column showing the City’s level of service standards for each roadway. This comment also applies to Tables 8 and 10.

**Response:** Agree, Tables 6, 8, and 10 will be revised to show the City’s LOS standard as defined in the City’s Comprehensive Plan Policy MOB-2-1.1 and MOB-2-2-1.2. The v/c ratios will be displayed within the tables as well.

**DPA Response:** Comment addressed.

**Response 2:** Noted. No further action or changes required.

10. **Table 7** - It is not clear why the arterial analysis was based on speed instead of traffic volume. Please consider performing a roadway segment analysis based on peak period traffic volumes to be consistent with the City’s Comprehensive Plan (Policy MOB-2.1.1).

**Response:** The arterial analysis results shown in Table 7 are based on the AM and PM peak traffic volumes which were entered into Synchro 10 in order to compute the arterial speed. As per the Highway Capacity Manual, arterial LOS is a function of the class of arterial under study and the **travel speed** along the arterial.

**DPA Response:** Comment addressed.

**Response 2:** Noted. No further action or changes required.

11. **Table 7** - Please include a column showing the City’s level of service standards for each roadway segment. This comment also applies to Tables 9 and 11.

**Response:** Please refer to response for Comment #10. City level of service standards will be outlined in the text and shown in Tables 6, 8, and 10.

**DPA Response:** Comment addressed.

**Response 2:** Noted. No further action or changes required.

12. **Section 3.6** – All proposed parking spaces will be shared by the residential, office and retail users. Please update parking analysis to reflect this.

**Response:** Please refer to response for Comment #2.

**DPA Response:** Comment not addressed. As mentioned before, the site plan has been modified since the start of the traffic study. The revised site plan proposes 362 parking spaces. It was confirmed with the developer and the architect that the intent is to have one (1) reserved parking space for each residential unit (215 spaces) and to share the remaining number of spaces between residential, office and retail uses. Please update the parking analysis as appropriate. In particular, please update Table 15 to reflect that the project’s

proposed parking complies with the City's parking requirements pursuant to the shared parking matrix provided in Section 5-1410(B)(2) of the Zoning Code.

**Response 2:** Agree, we have contacted the Architect again and obtained the updated parking information. The parking analysis will be updated to account for the parking spaces that are to be shared between residential, office and retail uses. We shall adhere to the City's parking requirements provided in Section 5-1410(B)(2) of the Zoning Code.

13. **Section 4** – The report concludes that some intersection approaches are operating and will continue to operate below the City's LOS standards. However, the study does not identify the LOS standards adopted by the City in their Comprehensive Plan.

**Response:** Agree, the City's LOS standards adopted in the Comprehensive plan will be stated in the report.

**DPA Response:** Comment addressed.

**Response 2:** Noted. No further action or changes required.





# TRAFFIC IMPACT STUDIES

CONSULTING SERVICES  
FOR 250 MERRICK  
MIXED USE BUILDING



CITY OF CORAL GABLES  
Department of Public Works

Presented by:



A&P Consulting Transportation  
Engineers, Corp.

## Engineer's Certification

I, Elio R. Espino, P.E., certify that I currently hold an active Professional Engineer's License in the State of Florida and I am competent through education and experience to provide engineering services in the civil and traffic engineering disciplines contained in this report. I further certify that this report was prepared by me or under my responsible charge as defined in Chapter 61G15-18.011 and that all statements, conclusions and recommendations made herein are true and correct to the best of my knowledge and ability.

**Project:** Traffic Impact Study for 250 Merrick Mixed Use Building

**Location:** 250 Bird Road  
City of Coral Gables, Miami-Dade County, Florida

**Prepared for:**

City of Coral Gables, Department of Public Works

**Prepared by:**

A & P Consulting Transportation Engineers Corp.



Date 5/28/2020

## TABLE OF CONTENTS

<b>1. INTRODUCTION .....</b>	<b>5</b>
1.1 Project Background .....	5
1.2 Study Objective.....	5
1.3 Study Methodology.....	7
Data Collection .....	7
Traffic Analysis.....	7
<b>2. DATA COLLECTION &amp; EXISTING CONDITIONS.....</b>	<b>8</b>
2.1 Seventy Two-Hour Vehicular Traffic Counts .....	8
2.2 Four-Hour Turning Movement Counts (TMCs).....	8
2.3 Signalized Intersection Data .....	11
2.4 Land Uses .....	13
2.5 Multimodal Facilities .....	13
2.6 Future Approved and Funded Transportation Projects.....	13
2.7 Field Reviews .....	15
<b>3. TRAFFIC ANALYSIS.....</b>	<b>16</b>
3.1 Background Traffic and Committed Developments .....	16
3.2 Trip Generation.....	18
3.3 Project Trip Distribution .....	19
3.4 Level-of-Service Analysis (LOS) .....	21
Existing Conditions Analysis .....	21
Future without Project Analysis .....	23
Future with Proposed Project Analysis .....	25
3.5 Multimodal LOS.....	28
3.6 Parking Analysis.....	30
<b>4. CONCLUSION.....</b>	<b>32</b>

## LIST OF FIGURES

Figure 1 - Location Map .....	6
Figure 2. Existing Lane Configuration at Analyzed Intersections .....	9
Figure 3. Existing Traffic Volumes (AM & PM Peak Periods).....	10
Figure 4. Future W/O Project Traffic Volumes (AM & PM Peak Periods).....	17
Figure 5. Project Trip Distribution .....	20
Figure 6. Future with Project Traffic Volumes (AM & PM Peak Period) .....	26

## LIST OF TABLES

Table 1. Signal Change and Clearance Intervals .....	12
Table 2. Field Review Summary .....	15
Table 3. Committed Development Trip Generation .....	16
Table 4. Project Trip Generation Summary .....	19
Table 5. Cardinal Distributions for TAZ 1098.....	19
Table 6. Existing Intersection Capacity Analysis for Weekday AM and PM Peak Hours.....	22
Table 7. Existing Arterial Capacity Analysis for AM and PM Peak Hours.....	23
Table 8. Future without Project Intersection Capacity Analysis for AM and PM Peak Hours.....	24
Table 9. Future without Project Arterial Capacity Analysis for AM and PM Peak Hours.....	25
Table 10. Future with Project Intersection Capacity Analysis for AM and PM Peak Hours .....	27
Table 11. Future with Project Arterial Capacity Analysis for AM and PM Peak Hours.....	28
Table 12. Existing Conditions Multimodal LOS.....	29
Table 13. Future Conditions Multimodal LOS .....	29
Table 14. Amount of Required Parking as per City of Coral Gables Zoning Code .....	30
Table 15. City of Coral Gables Shared Parking Analysis .....	31
Table 16. Required Loading Spaces .....	31

**Appendix A: Site Plan**

**Appendix B: Vehicular Traffic Counts**

**Appendix C: Peak Season Factor Category Report**

**Appendix D: Signal Timing Data**

**Appendix E: County and City Transit Maps**

**Appendix F: Recent and Future Approved and Funded Transportation Projects**

**Appendix G: Historic Growth Rate Data & Analysis**

**Appendix H: Committed Development Trip Generation**

**Appendix I: Trip Generation and Internal Capture Rate**

**Appendix J: Cardinal Traffic Analysis Zone Trip Distribution**

**Appendix K: Synchro Level-of-Service (LOS) Output Reports**

**Appendix L: Multimodal Level-of-Service (LOS) Output Reports**

**Appendix M: Parking Generation Analysis**

# 1. INTRODUCTION

## 1.1 Project Background

The development will be located at 250 Bird Road, between Aurora Street and Salzedo Street along SR 976/Bird Road in Coral Gables, Florida. The project proposes an 11-story (120 feet) mixed-use building providing 215 residential units, 11,840 square feet of new retail space, and 22,591 square feet of office space. The existing office building on the southwest corner (at Bird Road and Salzedo Street) of the property will be renovated and maintained. Please note that the project is within the Gables Redevelopment Infill District (GRID) and therefore is within a Traffic Concurrency Exemption Area.

The development proposes an onsite parking garage providing a total of 362 parking spaces. One (1) parking space will be reserved for each residential unit (215 spaces) and the remaining number of spaces will be shared between residential, office and retail uses. Access to and from the parking garage, including loading access, to the site will be provided through a single driveway on Aurora Street. A project location map is included as **Figure 1** and a site plan is provided in **Appendix A**. The project is expected to be completed by the year 2022. This traffic impact study is consistent with the methodology previously agreed upon by the developer and the City of Coral Gables Public Works Department.

## 1.2 Study Objective

The purpose of this study is to conduct a traffic impact analysis of the proposed development on the adjacent roadway network. This study includes an analysis of the roadway and intersection capacity, trip generation, parking requirements, and a review of the suitability to accommodate pedestrians in the project area.

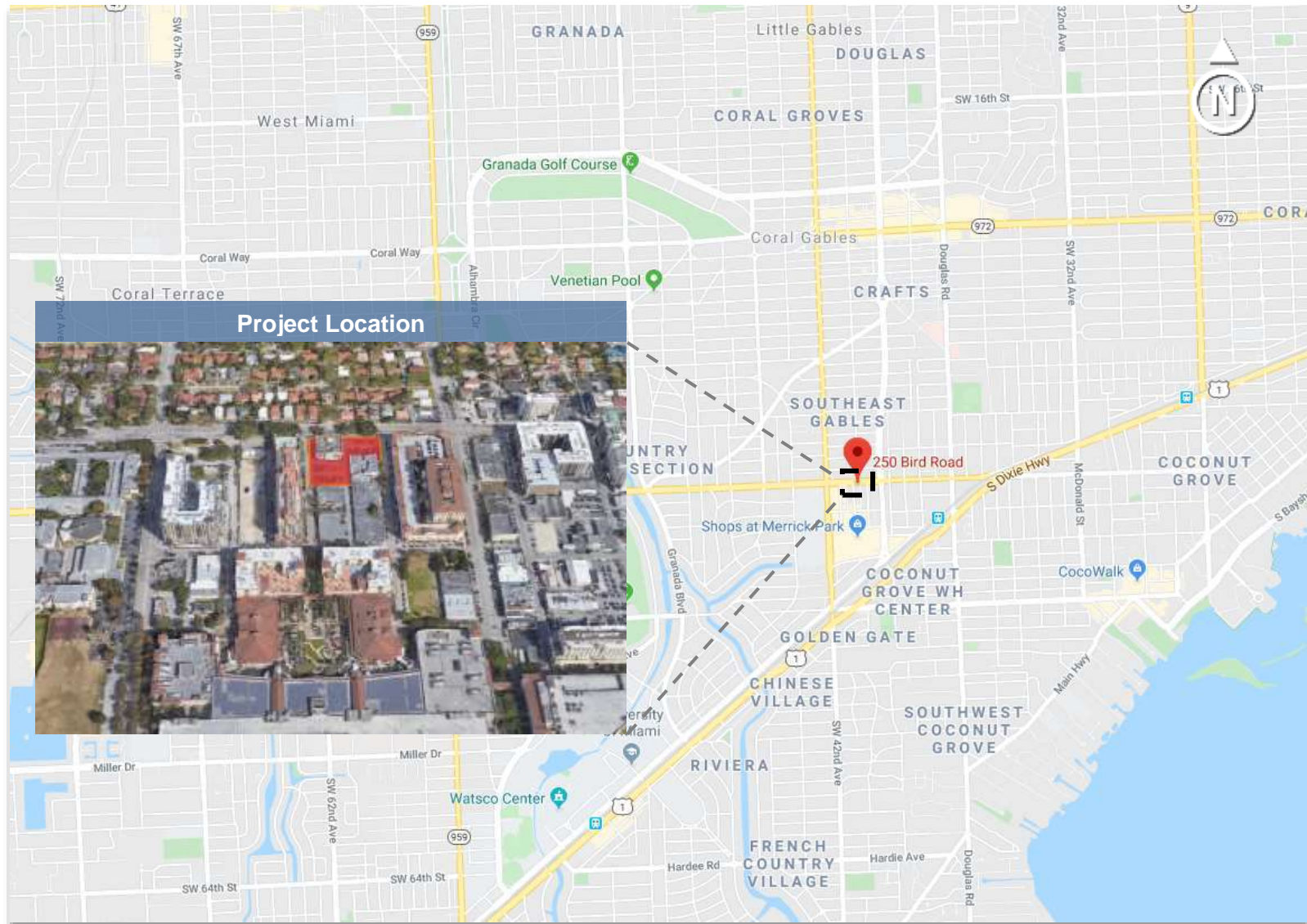

Figure 1 - Location Map

### 1.3 Study Methodology

The study methodology is based upon the City of Coral Gables' Traffic Impact Study Process and Methodology document. The traffic impact study requirements were previously discussed with and approved by the City of Coral Gables at a methodology meeting held on October 30, 2019 with the developer. A summary of the study tasks and methodology is as follows:

#### Data Collection

- Collect 72-Hour vehicular traffic counts during typical weekdays (Tuesday, Wednesday, and Thursday) avoiding holidays, adverse weather events, school closures, special events, and/or incidents.
- Collect 4-Hour Turning Movement Counts (TMCs), two hours each during the AM and PM peak periods.
- Obtain and review all relevant documentation; including intersection signal data (check operations and clearances), traffic impact studies of previously committed developments, list of programmed transportation projects, and any citizen complaints made within the vicinity of the study development.
- Conduct field reviews during the AM and PM peak periods on a typical weekday to assess traffic operations at the adjacent roadway links, intersections, and identify existing attractors/generators in the area.

#### Traffic Analysis

- Develop project specific trip generation rates and distribute traffic along surrounding roadway network.
- Develop future projected traffic volumes.
- Conduct multimodal level-of-service (LOS) analysis for existing, future without development, and future with build-out development conditions.
- Conduct a parking generation analysis for the mixed-use development.



## 2. DATA COLLECTION & EXISTING CONDITIONS

### 2.1 Seventy Two-Hour Vehicular Traffic Counts

Bi-directional traffic counts were collected on Tuesday, January 21 through Thursday, January 23, 2020 at the following roadway segments:

- SR 976/Bird Road between SR 953/Le Jeune Road and Ponce De Leon Boulevard
- Aurora Street between Altara Avenue and SR 976/Bird Road
- Altara Avenue between SR 953/Le Jeune Road and Ponce De Leon Boulevard
- Ponce De Leon Boulevard between San Lorenzo Avenue and SR 976/Bird Road
- SR 953/Le Jeune Road between Altara Avenue and SR 976/Bird Road

Peak periods were chosen from these bi-directional counts. The counts revealed that the overall AM peak hours of traffic were from 7 AM to 9 AM and the PM peak hours of traffic were from 4 PM to 6 PM. The 72-hour bidirectional counts are provided in **Appendix B**.

### 2.2 Four-Hour Turning Movement Counts (TMCs)

Four-hour TMCs were collected for the AM Peak and PM Peak hours (two hours per peak period) on January 28, 2019 at the following intersections:

- SR 953/Le Jeune Road and SR 976/Bird Road (Signalized)
- SR 953/Le Jeune Road and Altara Avenue (Signalized)
- Ponce De Leon Boulevard and SR 976/Bird Road (Signalized)
- Ponce De Leon Boulevard and Altara Avenue (Unsignalized)
- Ponce De Leon Boulevard and San Lorenzo Avenue (Signalized)
- SR 976/Bird Road and Aurora Street (Unsignalized)
- Altara Avenue and Aurora Street (Unsignalized)

A PSCF of 1.02 was applied to the traffic movement counts to account for seasonal variations. These counts, with minor volume balancing adjustments, were utilized in the capacity analysis for the existing conditions, as well as for future conditions with a growth rate applied. The existing lane configuration and signalization at the analyzed intersections are shown in **Figure 2**, and the existing turning movement volumes are shown in **Figure 3**. Traffic movement counts are provided in **Appendix B** and FDOT peak season factor report in **Appendix C**.

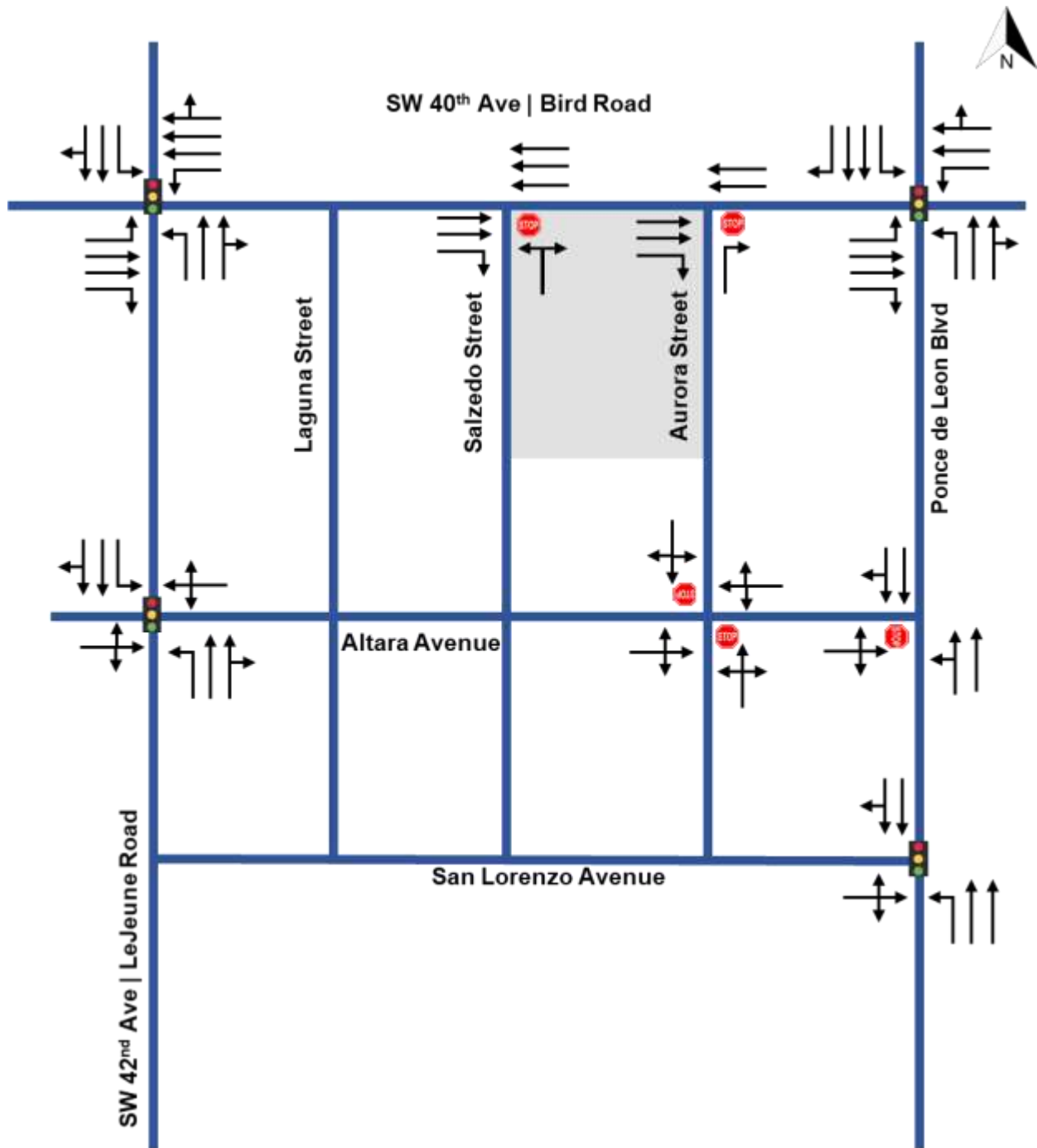
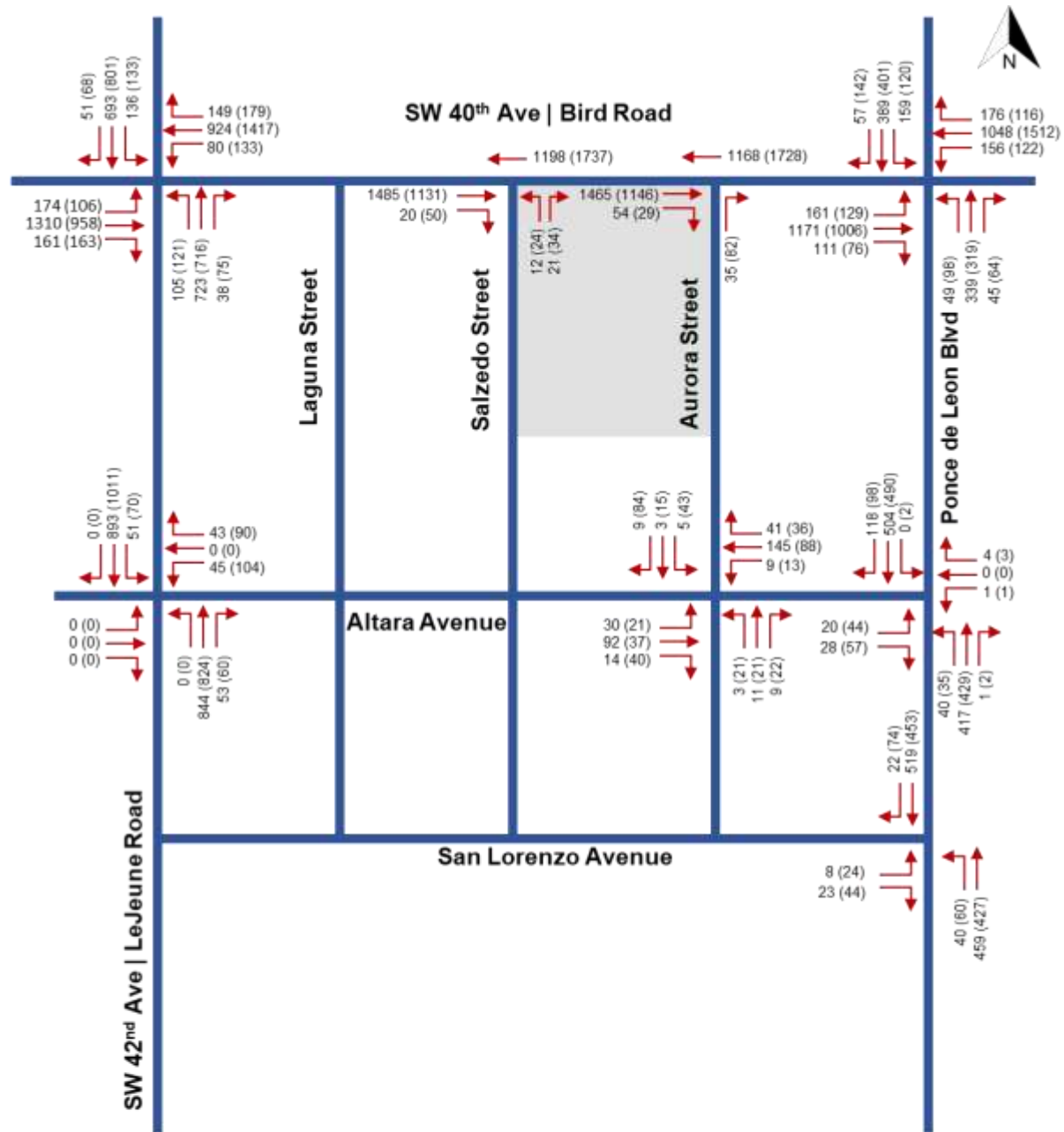

Figure 2. Existing Lane Configuration at Analyzed Intersections



**Legend**

00 = AM Peak Hour  
 (00) = PM Peak Hour  
 Intersection Volumes →

Figure 3. Existing Traffic Volumes (AM & PM Peak Periods)

### 2.3 Signalized Intersection Data

Signal timing data for the four signalized study intersections was obtained from Miami-Dade County's Traffic Signals and Signs Division (TS&S) of the Department of Transportation and Public Works (DTPW). The four intersections within the study area are semi-actuated; vehicle actuation is provided via loop detection and pedestrian actuation via push buttons. The intersections of SR 976/Bird Road at SR 953/Le Jeune Road and SR 976/Bird Road at Ponce de Leon Boulevard operate under four signal phases, while the intersection of Ponce de Leon Boulevard at San Lorenzo Avenue operate under two signal phases, and Le Jeune Road at Altara Avenue under three signal phases.

The traffic signals along SR 976/Bird Road are within an eastbound/westbound coordinated section (Signal Section "49 Bird Road"), the signals are coordinated eastbound/westbound during both the AM peak and PM peak hours. The other two intersections are not within a coordinated section; however, offsets are set to provide vehicle progression in the north and south directions, when possible. All the signals within the study area operate with a cycle length of 180 seconds during the AM and PM peak hours.

An assessment of signal timing data with respect to traffic signal change and clearance intervals for both vehicles and pedestrians was performed to verify that the controllers' safety parameters meet the minimum standards required by the Manual on Uniform Traffic Control Devices (MUTCD). The assessment indicated that the FLASHING DON'T WALK time for the eastbound crosswalk at SR 953/Le Jeune Road and San Lorenzo Avenue does not meet the minimum pedestrian clearance interval. Based on MUTCD methodology the FLASHING DON'T WALK interval for the eastbound movement (Phase 8) must be 14 seconds. All other intersections meet the minimum standards. The results are provided in **Table 1** below.

Furthermore, the signal timing data was used to develop the existing and future scenarios in Synchro 10 for the capacity analysis. The traffic signal data is provided in **Appendix D**.

**Table 1. Signal Change and Clearance Intervals**

2595 - Bird Road & Le Jeune Rd										
Timing Function No.	1	2	3	4	5	6	7	8	Meet MUTCD ?	
Movement Direction	EBL	WBT	SBL	NBT	WBL	EBT	NBL	SBT		
Timing Parameters	Yellow Change	4	4	4.4	4.4	4	4	4.4	4.4	Yes
	Red Clearance	2	2	2.5	2.5	2	2	2.5	2.5	Yes
	Walk Time		7		7		7		7	Yes
	Flashing Don't Walk		14		24		14		24	Yes

2594 - Bird Road and Ponce de Leon Blvd										
Timing Function No.	1	2	3	4	5	6	7	8	Meet MUTCD ?	
Movement Direction	EBL	WBT	SBL	NBT	WBL	EBT	NBL	SBT		
Timing Parameters	Yellow Change	4	4	3.7	4	4	4	3.7	4	Yes
	Red Clearance	2.3	2.3	3.1	3.1	2.3	2.3	3.1	3.1	Yes
	Walk Time		7		7		7		7	Yes
	Flashing Don't Walk		26		26		26		26	Yes

3272 - Le Jeune Road and Altara Ave										
Timing Function No.	1	2	3	4	5	6	7	8	Meet MUTCD ?	
Movement Direction		SBT		WBT		NB T		EBT		
Timing Parameters	Yellow Change		4		4		4		4	Yes
	Red Clearance		2		2.3		2		2.3	Yes
	Walk Time								7	Yes
	Flashing Don't Walk								13	Yes

6165 - Ponce de Leon Blvd and San Lorenzo Ave										
Timing Function No.	1	2	3	4	5	6	7	8	Meet MUTCD ?	
Movement Direction	NBL	SBT				NB T		EBT		
Timing Parameters	Yellow Change	3.7	4				4		4	Yes
	Red Clearance	2.6	2.6				2.6		2.3	Yes
	Walk Time								7	Yes
	Flashing Don't Walk								10	<b>No</b>

## 2.4 Land Uses

The land uses in the vicinity of the development are low density single-family, business and commercial, and mixed-use business/residential. Some major trip generators/attractors within the development study area are the Shops at Merrick Park, The Collection, Coral Gables High School, and the mixed-use developments directly adjacent to and west of the proposed development.

## 2.5 Multimodal Facilities

A continuous network of sidewalk, with curb and gutter, from the major roadway facilities to the project location is provided on both sides of SR 976/Bird Road, SR 953/Le Jeune Road, Ponce de Leon Boulevard, and Aurora Street. Two-stripe high emphasis crosswalks with pedestrian curb ramps, detectable warnings, countdown pedestrian signal heads, and pedestrian push buttons are provided on all signalized intersections. There are no bicycle facilities (exclusive bicycle lane or shared bicycle pavement markings) in the vicinity of the project. The project site can be accessed via transit through three different transit systems: Miami-Dade Metrobus (Routes 40- Bird Road and 42- Le Jeune Road), Coral Gables Trolley (along Ponce de Leon Boulevard), and Miami-Dade Metrorail. There is a total of seven bus stops: three along SR 976/Bird Road, two along SR 953/Le Jeune Road and two along Ponce de Leon Boulevard. The closest Metrorail station (Douglas Road Station) is located at the intersection of SW 37<sup>th</sup> Avenue/Douglas Road and US-1 at an approximate distance of 0.66 miles. Miami-Dade County and City transit maps are provided in **Appendix E**.

## 2.6 Future Approved and Funded Transportation Projects

FDOT's Five Year Work Program was reviewed and there are two roadway resurfacing projects in the vicinity of the project with construction funding set for Fiscal Year 2024: 446001.1 – SR 976/Bird Road from east of Launa Street to west of SW 38 Avenue and 446002.1 – SR 953/Le Jeune Road from S. Dixie Highway to south of Altara Avenue.

The Miami-Dade County's 2045 Long Range Transportation Plan (LRTP) was also reviewed for any multimodal improvements for the roadways in the vicinity of the project. There is a congestion management process (CMP) project along SR 976/Bird Road for Bus Rapid Transit from SW 67 Street to US-1/S. Dixie Highway with a funded planning period between 2026 to 2030. There are also several pedestrian and bicycle facility improvements, however all these projects are currently unfunded projects with in the 2045 LRTP and Bicycle Pedestrian Master Plan. There are two

proposed On-Road Bicycle and Pedestrian Facility Improvement projects to be installed along Ponce de Leon Boulevard and Salzedo Street and a pedestrian facility enhancements project along SR 976/Bird Road near the proposed development. Since these bicycle and pedestrian are currently unfunded and the Bus Rapid Transit is planned for several years beyond the build-out date of the development, they were not included in the multimodal analysis for the future conditions.

Additionally, FDOT's Correspondence Tracking Program (CTP) was accessed to identify any traffic operation deficiency reported through the citizen complaint program within the past five years. The system website revealed that there were six CTPs from 2015 to present, however the majority of the citizen concerns have already been addressed. The one CTP in 2019 triggered a bottleneck analysis traffic study for the intersection of SR 976/Bird Road and SR 953/Le Jeune Road. The intent of the analysis was to evaluate short term, low cost treatments to reduce the duration and intensity of congestion and improve mobility through the intersection. Another recently completed FDOT project (FPID 434766-1-52-01) at the same intersection provided for backplates for the signal heads on the eastbound and westbound approaches, as well as re-designed the left turn lanes to be offset and to provide additional green time for the eastbound/westbound left turn phases.

Excerpts from the FDOT Work Program, Miami-Dade's LRTP, and FDOT Project Suite are provided in **Appendix F**.

## 2.7 Field Reviews

Two field reviews were conducted on February 4, 2020 during the AM (7-9 AM) and PM (4-6 PM) peak hours to assess traffic operations at the adjacent roadway links, intersections, and existing attractors/generators in the area. A summary of the field reviews is provided in **Table 2**.

**Table 2. Field Review Summary**

Intersection	Field Observations	Comments
Asset 2595 - Bird Rd & Le Jeune Rd	Through traffic was observed to operate efficiently. School traffic did not seem to have a negative impact on the intersection capacity nor the corridor progression. However, the southbound left and westbound left turn movements were observed to have an overflow queue in multiple cycles during the AM and PM peak hours.	Basic signal timing changes, such as allocating more green time to the left turn phases has the potential to mitigate this issue and improve southbound and northbound traffic flow and increase the westbound left turn lane capacity.  Please note that the pedestrian pushbutton in the northeast corner was observed to be out of service. Miami-Dade County TS&S should be notified of this issue.
Asset 2594- Bird Rd & Ponce De Leon Blvd	The intersection was observed to operate well. No excessive delay nor capacity issues were observed. Timing plans for the AM and PM peak hours have enough green time to accommodate the traffic demand.	
Asset 3272 - Altara Ave & Le Jeune Rd	There were no traffic operation deficiencies observed at this intersection during the AM peak hours. However, the PM peak hours experienced multiple pedestrian-vehicle conflicts between the westbound left turn movement and pedestrians crossing the south crosswalk.	A traffic operation and safety study should be performed at this intersection to evaluate the signal operating plan (SOP) and provide a signal timing or geometric design mitigation strategy. It is important to note that most vehicles in the westbound movement turn left or right.
Asset 6165 - Ponce De Leon Blvd & San Lorenzo Ave	The intersection was observed to operate well. Due to the low vehicle volume during the AM and PM peak hours no excessive delay or capacity issues were observed.	The eastbound loop detector is damaged, so the intersection is operating in max recall mode. Miami-Dade County TS&S Division should be notified of this issue so that the traffic signal operates efficiently. Future traffic demand may require the signal to operate in semi-actuated mode to efficiently accommodate the heaviest movement.



### 3. TRAFFIC ANALYSIS

#### 3.1 Background Traffic and Committed Developments

Annual Average Daily Traffic (AADT) counts published by the Florida Department of Transportation (FDOT) were reviewed, and the FDOT Traffic Trend Analysis tool was used to determine the historic growth rate in the area; following the Project Traffic Forecasting Handbook guidelines. The analysis revealed that traffic has decreased in the past years. Nevertheless, a conservative 1.0% annual growth rate was applied for this study. The historic growth rate data and future traffic projections are provided in **Appendix G**.

Three committed developments were identified and included in the analysis for estimating future traffic volumes: Gables Living, Merrick Manor and The Henry. **Table 3** provides the net external trips generated by these developments during the AM and PM peak hours. The future turning movement volumes without the proposed development are shown in **Figure 3**. Detail information on the committed developments trip generation is provided in **Appendix H**.

**Table 3. Committed Development Trip Generation**

Project	Vehicle Trips	AM Peak Trips			PM Peak Trips		
		Entry	Exit	Total	Entry	Exit	Total
Gables Living		23	37	60	44	33	77
Merrick Manor	Net External Trips (Proposed)	22	79	101	109	59	168
The Henry		13	51	64	61	41	102

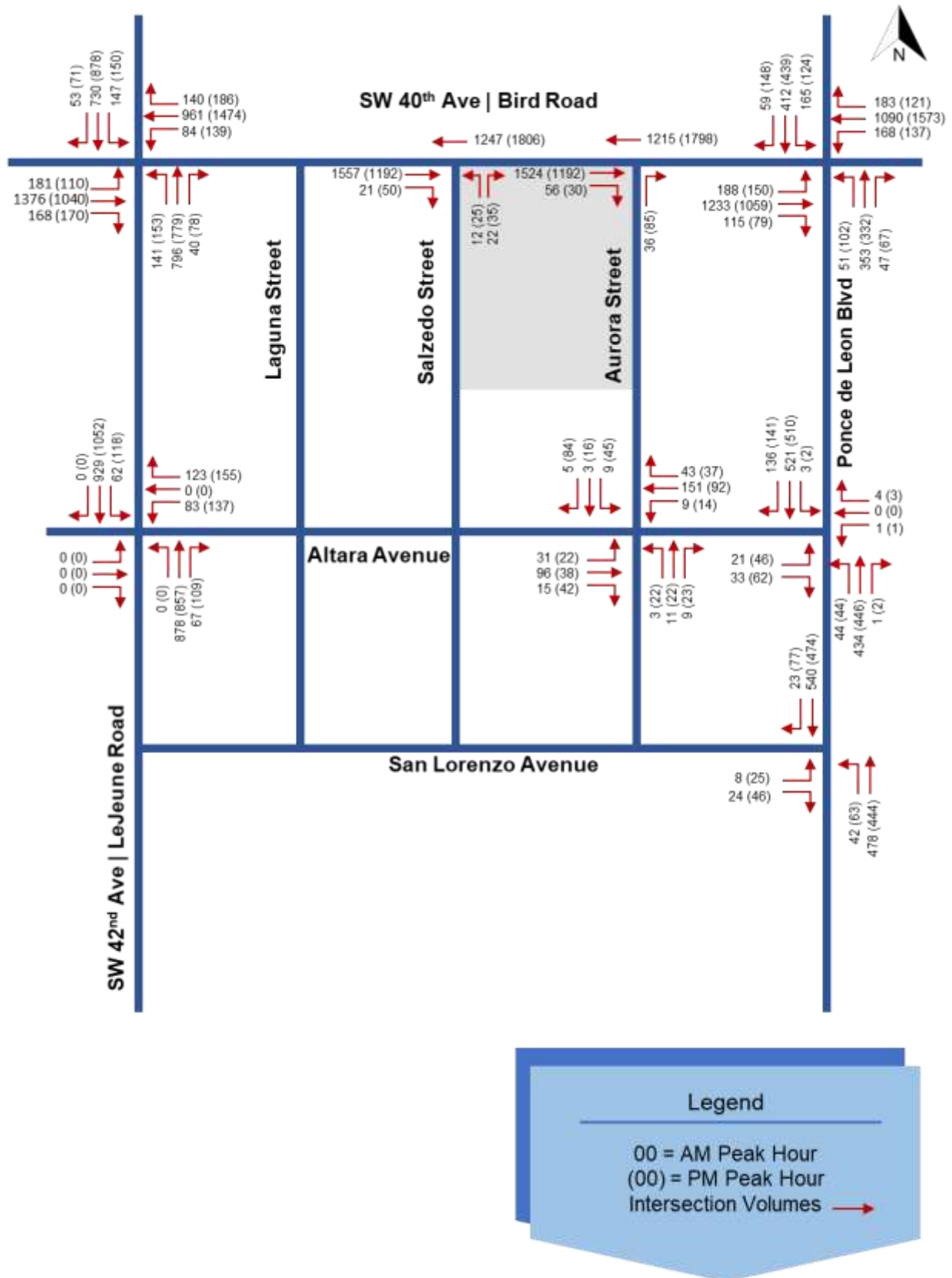

Figure 4. Future W/O Project Traffic Volumes (AM & PM Peak Periods)

### 3.2 Trip Generation

The methodology outlined in the Institute of Transportation Engineers (ITE), Trip Generation Report 10th Edition was used to forecast traffic based on the proposed project land uses. Weekday AM and PM peak hour trips were estimated. Trip generation was determined using ITE Land Use Codes 221 (Mid-Rise Multifamily Housing), 820 (Shopping Center), and 710 (General Office Building). **Table 4** summarizes the project's expected trip generation for both peak periods.

The field review conducted on February 4, 2020 revealed that the existing office building that will be remodeled and maintained as part of the proposed project is currently unoccupied. Thus, the project trip generation analysis did not include any existing trips. All proposed land uses were considered as new external trips.

Due to the complementary nature of the proposed project's land uses, there are some trips that are expected among the on-site uses. The internal capture trips for the project were determined based upon methodology contained in the ITE Trip Generation Handbook, 3rd Edition. The AM peak hour internal capture rate is expected to be 8%, while the PM peak hour internal capture rate is expected to be 16%. The applied internal capture percentages are presented in **Table 4**. See **Appendix I** for trip generation report and internal capture rates sheets.

The available pass-by data showed an unrealistic reduction in the calculated through volume on the adjacent roads for the proposed development. As such, due to the difficulty to obtain high correlation indices for pass-by data and the nature of the project's land uses, pass-by trips were not included in the trip generation analysis.

**Table 4. Project Trip Generation Summary**

Proposed ITE Land Use Code <sup>1</sup>	Size/Units	Daily Vehicle Trips	AM Peak Trips			PM Peak Trips		
			Entry	Exit	Total	Entry	Exit	Total
Multifamily Housing (Mid-Rise) Land Use Code: 221	215 units	1170	18	54	72	56	36	92
Office Land Use Code: 710	22,591 SF	251	41	7	48	4	24	28
Retail/Shopping Center Land Use Code: 820	11,840 SF	447	7	4	11	22	23	45
Subtotal Gross Trips		1868	66	65	131	82	83	165
Internalization <sup>2</sup>	AM 8.2%	N/A	-5	-5	-11	-13	-13	-26
	PM 15.6%							
<b>Net External Trips (Proposed)</b>				<b>61</b>	<b>60</b>	<b>120</b>	<b>69</b>	<b>70</b>

<sup>1</sup> Based on ITE Trip Generation Manual, 10th Edition

<sup>2</sup> Based on ITE Trip Generation Handbook, 3rd Edition

### 3.3 Project Trip Distribution

The trip distribution was based on a cardinal trip distribution for the project site’s traffic analysis zone (TAZ 1098) obtained from the Miami-Dade Metropolitan Planning Organization’s (MPO’s) 2040 Cost Feasible Plan travel demand model. Roadways available to travel to the desired location, and attractiveness and convenience of traveling on a specific roadway were factors considered when determining the project trip distribution. The distribution percentages are presented in **Table 5** and in **Figure 4** graphically. The distribution data is provided in **Appendix J**.

**Table 5. Cardinal Distributions for TAZ 1098**

Direction	% Distribution
NNE	23.1
ENE	15.3
ESE	4.3
SSE	1.8
SSW	11.1
WSW	17.5
WNW	10.2
NNW	16.6
Total	100

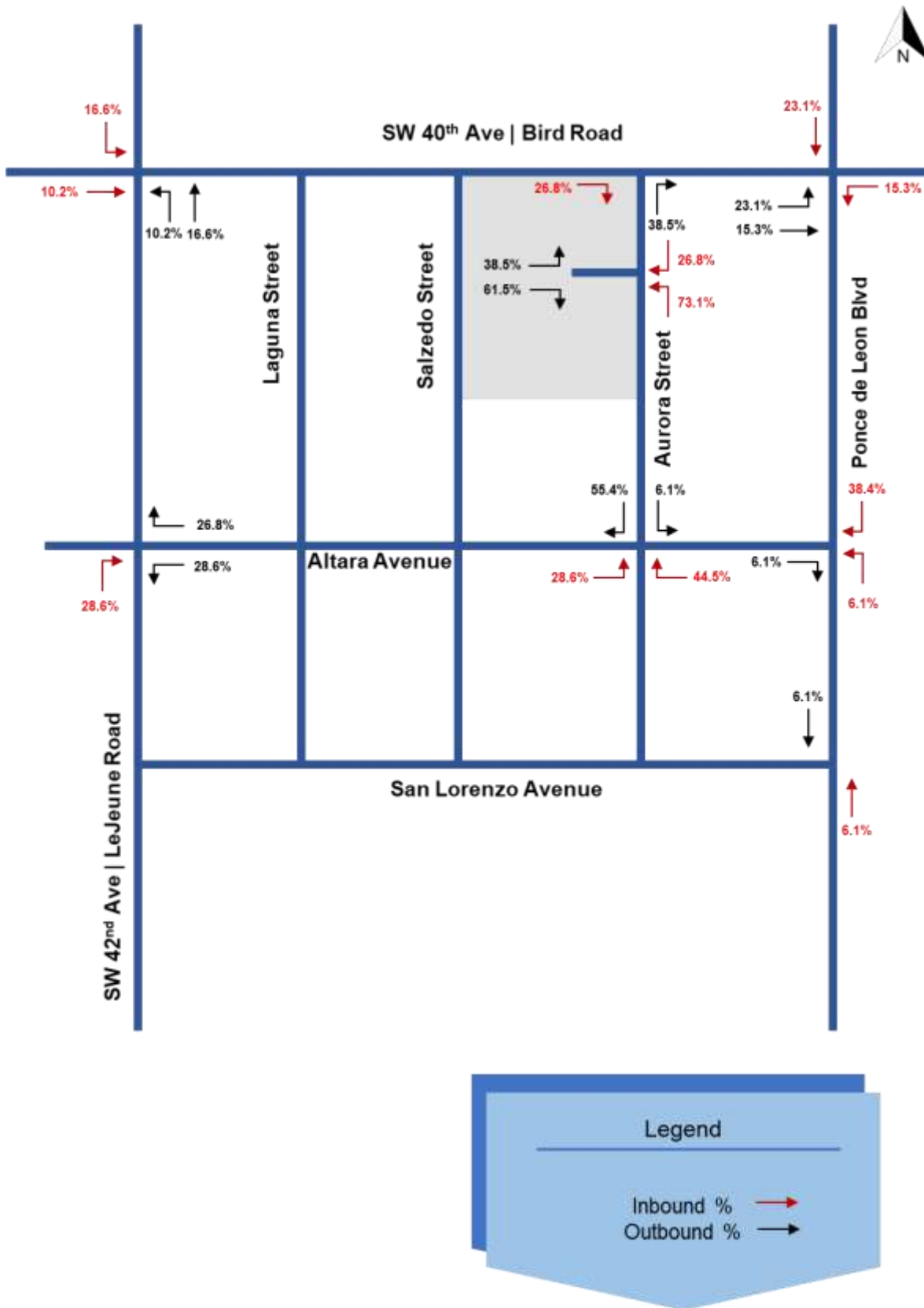

Figure 5. Project Trip Distribution

### 3.4 Level-of-Service Analysis (LOS)

The LOS analysis was performed using the study area network modeled in Synchro 10 (HCM 6<sup>th</sup> Edition) for the existing conditions and for the future opening year (with and without proposed development) of 2022, for the AM and PM peak periods. Volumes for the model were obtained via turning movement counts, trip generation and distribution, and committed developments. It is important to note that the proposed development is located within the city of Coral Gables Redevelopment and Infill District, which is a Transportation Concurrency Exemption Area. The Synchro reports for each peak hour period and scenario are provided in **Appendix K**.

Signalized intersection LOS is stated in terms of average control delay per vehicle (in seconds) during a specified time period (e.g., weekday AM peak hour). LOS is measured based on many variables, including signal cycle length and traffic volumes with respect to intersection capacity and resulting queues.

Unsignalized intersection LOS is reduced into three intersection types: all-way stop, two-way stop, and roundabout control. In this study, only two-way stop-controlled intersections were analyzed. Two-way stop-controlled intersection LOS is defined in terms of the average control delay for each minor-street movement (or shared movement) as well as major-street left-turns. This approach is because major street through vehicles are assumed to experience zero delay, a weighted average of all movements results in very low overall average delay.

The LOS values estimated for the three proposed scenarios were compared to the City's LOS standard (LOS E) adopted in their Comprehensive Plan (Policy MOB-2.1.1).

#### Existing Conditions Analysis

The existing conditions LOS was calculated using the TMCs collected at the eight study intersections. **Table 6** and **7** show the resulting LOS for the existing conditions during the AM and PM peak periods for each intersection and roadway segment within the study area, respectively.

**Table 6. Existing Intersection Capacity Analysis for Weekday AM and PM Peak Hours**

Intersection	Int. <sup>1</sup> Type	Direction	AM Peak Delay (sec)	AM Peak LOS	AM v/c	PM Peak Delay (sec)	PM Peak LOS	PM v/c	Meet City's LOS E Std?	Meet City's v/c (1.5) std?	
Bird Road & Ponce de Leon Blvd	S	NB	90.7	F	0.89	101.4	F	0.89	No	Yes	
		SB	85.2	F	0.72	80.7	F	0.81	No	Yes	
		EB	26.3	C	0.66	9.0	A	0.52	Yes	Yes	
		WB	30.1	C	0.69	31.7	C	0.81	Yes	Yes	
		Intersection	44.1	D	N/A	41.1	D	N/A	Yes	N/A	
Bird Road & Le Jeune Road	S	NB	89.6	F	0.93	79.0	E	0.86	No	Yes	
		SB	91.0	F	0.91	92.3	F	0.93	No	Yes	
		EB	31.0	C	0.69	30.6	C	0.56	Yes	Yes	
		WB	28.7	C	0.41	3.7	A	0.61	Yes	Yes	
		Intersection	53.2	D	N/A	42.8	D	N/A	Yes	N/A	
Le Jeune Road & Altara Avenue	S	NB	3.0	A	0.31	6.3	A	0.33	Yes	Yes	
		SB	2.7	A	0.31	0.3	A	0.38	Yes	Yes	
		EB	No turning movement volumes								
		WB	87.6	F	0.67	81.7	F	0.8	No	Yes	
		Intersection	6.7	A	N/A	10.0	B	N/A	Yes	N/A	
Ponce de Leon Blvd & San Lorenzo Avenue	S	NB	2.2	A	0.18	2.7	A	0.16	Yes	Yes	
		SB	5.5	A	0.24	6.5	A	0.24	Yes	Yes	
		EB	40.4	D	0.47	39.9	D	0.61	Yes	Yes	
		Intersection	5.1	A	N/A	6.9	A	N/A	Yes	N/A	
Bird Road & Salzedo St	U	NB	38.5	E	0.24	42.5	E	0.38	Yes	Yes	
Bird Road & Aurora St	U	NB	16.9	C	0.10	15.5	C	0.21	Yes	Yes	
Altara Avenue & Aurora St	U	NB	14.1	B	0.10	11.4	B	0.10	Yes	Yes	
		SB	13.5	B	0.10	11.2	B	0.20	Yes	Yes	
Ponce de Leon Blvd & Altara Avenue	U	EB	18.0	C	0.15	20.9	C	0.30	Yes	Yes	

<sup>1</sup> S = Signalized, U = Un-signalized

**Table 7. Existing Arterial Capacity Analysis for AM and PM Peak Hours**

Segment	Direction	Arterial Class	AM Peak Speed	AM Peak LOS	PM Peak Speed	PM Peak LOS	City's LOS Std
Bird Road: b/w Le Jeune Road & Ponce de Leon Blvd	EB	II	10.9	E	14.3	D	E
	WB	II	11.2	E	10.4	E	E
Le Jeune Rd: b/w Bird Road & Altara Avenue	NB	III	8.7	F	9.7	F	E
	SB	III	9.2	F	10.0	F	E
Ponce de Leon Blvd: b/w Bird Road & San Lorenzo Avenue	NB	III	7.7	F	7.5	F	E
	SB	III	10.3	E	10.0	F	E
Altara Avenue: b/w Ponce de Leon Blvd and Le Jeune Road	WB	III	28.3	B	28.3	B	E
	EB	-	-	NA	-	NA	

### Future without Project Analysis

The future without project scenario was analyzed by adding background traffic with committed development trips. **Table 8** and **9** show the LOS analysis for the future conditions without the proposed development during the AM and PM peak period for each intersection and segment within the study area, respectively.



**Table 8. Future without Project Intersection Capacity Analysis for AM and PM Peak Hours**

Intersection	Int. <sup>1</sup> Type	Direction	AM Peak Delay (sec)	AM Peak LOS	AM v/c	PM Peak Delay (sec)	PM Peak LOS	PM v/c	Meet City's LOS E Std?	Meet City's v/c (1.5) std?	
Bird Road & Ponce de Leon Blvd	S	NB	91.6	F	0.90	107.1	F	0.89	<b>No</b>	<b>Yes</b>	
		SB	88.6	F	0.74	84.1	F	0.86	<b>No</b>	<b>Yes</b>	
		EB	30.5	C	0.71	19.9	B	0.56	Yes	Yes	
		WB	34.9	C	0.73	35.3	D	0.85	Yes	Yes	
		Intersection	47.9	D	N/A	47.1	D	N/A	Yes	N/A	
Bird Road & Le Jeune Road	S	NB	90.6	F	0.94	96.5	F	0.86	<b>No</b>	<b>Yes</b>	
		SB	98.9	F	0.94	97.8	F	0.94	<b>No</b>	<b>Yes</b>	
		EB	35.6	D	0.76	35.3	D	0.64	Yes	Yes	
		WB	32.0	C	0.44	4.7	A	0.67	Yes	Yes	
		Intersection	58.1	E	N/A	49.7	D	N/A	Yes	N/A	
Le Jeune Road & Altara Avenue	S	NB	7.2	A	0.36	10.9	B	0.39	Yes	Yes	
		SB	6.9	A	0.36	0.6	A	0.43	Yes	Yes	
		EB	No turning movement volumes								
		WB	80.6	F	0.82	85.9	F	0.87	<b>No</b>	<b>Yes</b>	
		Intersection	14.1	B	N/A	15.0	B	N/A	Yes	N/A	
Ponce de Leon Blvd & San Lorenzo Avenue	S	NB	2.3	A	0.18	2.7	A	0.17	Yes	Yes	
		SB	5.6	A	0.25	6.6	A	0.25	Yes	Yes	
		EB	40.4	D	0.47	40.1	D	0.62	Yes	Yes	
		Intersection	5.1	A	N/A	7.0	A	N/A	Yes	N/A	
Bird Road & Salzedo St	U	NB	43.8	E	0.28	51.9	F	0.46	<b>No</b>	<b>Yes</b>	
Bird Road & Aurora St	U	NB	17.6	C	0.12	16.1	C	0.22	Yes	Yes	
Altara Avenue & Aurora St	U	NB	14.3	B	0.10	11.5	B	0.12	Yes	Yes	
		SB	15.7	C	0.10	11.3	B	0.21	Yes	Yes	
Ponce de Leon Blvd & Altara Avenue	U	EB	19.0	C	0.18	23.8	C	0.38	Yes	Yes	

<sup>1</sup> S = Signalized, U = Un-signalized

**Table 9. Future without Project Arterial Capacity Analysis for AM and PM Peak Hours**

Segment	Direction	Arterial Class	AM Peak Speed	AM Peak LOS	PM Peak Speed	PM Peak LOS	City's LOS Std
Bird Road: b/w Le Jeune Road & Ponce de Leon Blvd	EB	II	10	E	13.6	E	E
	WB	II	10.3	E	9.9	F	E
Le Jeune Road: b/w Bird Road & Altara Avenue	NB	III	8.4	F	9.6	F	E
	SB	III	8.8	F	9.8	F	E
Ponce de Leon Blvd: b/w Bird Road & San Lorenzo Avenue	NB	III	7.7	F	7.5	F	E
	SB	III	10.2	E	9.7	F	E
Altara Avenue: b/w Ponce de Leon Blvd and Le Jeune Road	WB	III	28.3	B	28.3	B	E
	EB	-	-	NA	-	NA	

### Future with Proposed Project Analysis

The trip generation, traffic projections and committed development traffic were combined to obtain the total traffic for the future buildout scenario. **Figure 5** shows the projected AM and PM peak turning movement volumes. **Table 10** and **11** show the LOS analysis for the future conditions during the AM and PM peak periods for each intersection within the study area, respectively.

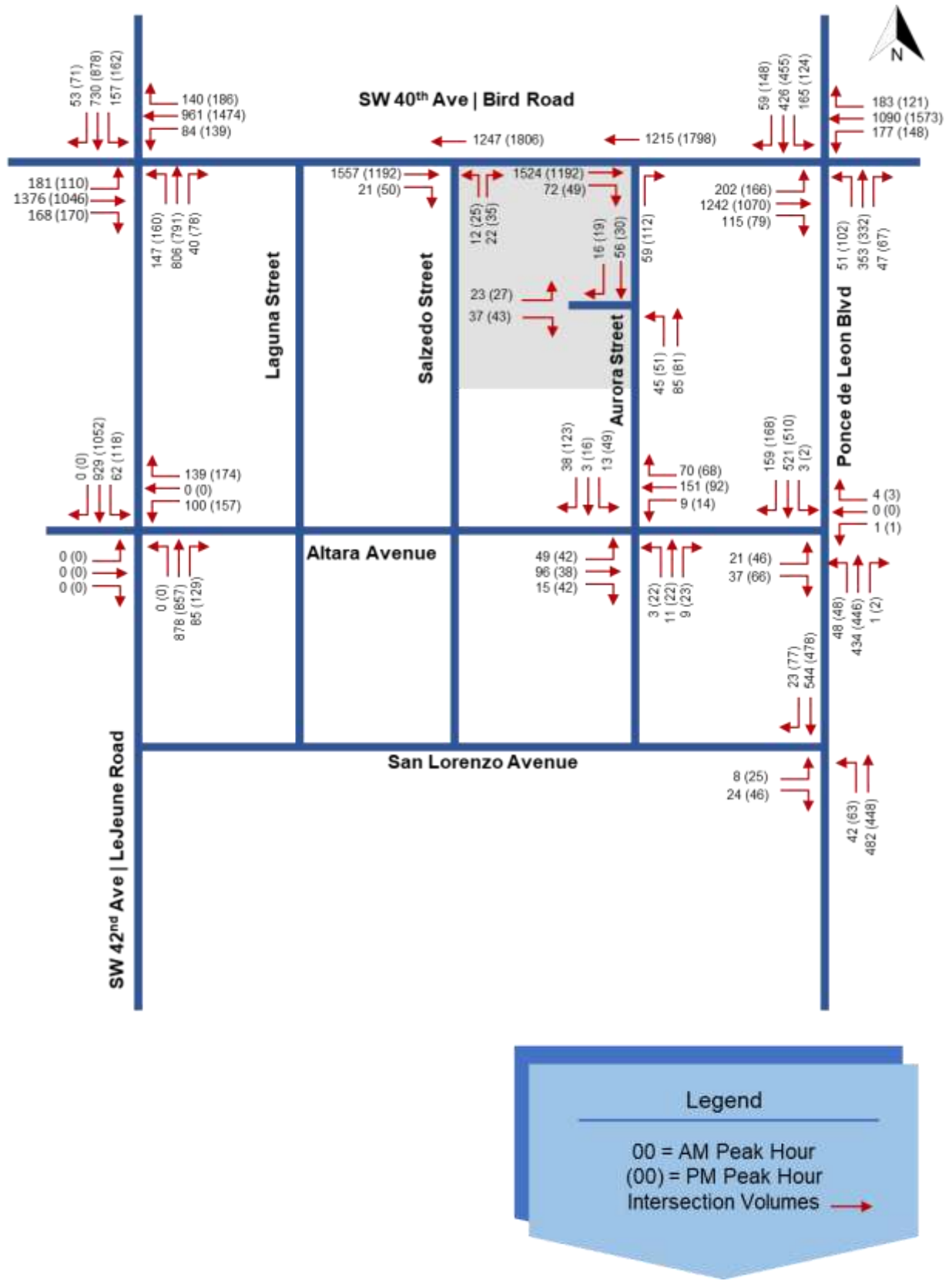

Figure 6. Future with Project Traffic Volumes (AM & PM Peak Period)

**Table 10. Future with Project Intersection Capacity Analysis for AM and PM Peak Hours**

Intersection	Int. <sup>1</sup> Type	Direction	AM Peak Delay (sec)	AM Peak LOS	v/c	PM Peak Delay (sec)	PM Peak LOS	v/c	Meet City's LOS E Std?	Meet City's v/c (1.5) std?	
Bird Road & Ponce de Leon Blvd	S	NB	91.6	F	0.90	109.7	F	0.89	<b>No</b>	<b>Yes</b>	
		SB	89.0	F	0.77	86.1	F	0.89	<b>No</b>	<b>Yes</b>	
		EB	32.2	C	0.72	26.9	C	0.57	Yes	Yes	
		WB	36.3	D	0.74	35.2	D	0.85	Yes	Yes	
		Intersection	49.2	D	N/A	49.7	D	N/A	Yes	N/A	
Bird Road & Le Jeune Road	S	NB	90.6	F	0.95	102.3	F	0.87	<b>No</b>	<b>Yes</b>	
		SB	103.0	F	0.94	105.4	F	0.94	<b>No</b>	<b>Yes</b>	
		EB	36.0	D	0.76	35.3	D	0.64	Yes	Yes	
		WB	32.4	C	0.44	4.7	A	0.67	Yes	Yes	
		Intersection	59.3	E	N/A	52.7	D	N/A	Yes	N/A	
Le Jeune Road & Altara Avenue	S	NB	8.8	A	0.39	13.0	A	0.42	Yes	Yes	
		SB	8.5	A	0.38	0.7	B	0.45	Yes	Yes	
		EB	No turning movement volumes							Yes	
		WB	78.4	E	0.84	87.8	F	0.89	<b>No</b>	<b>Yes</b>	
		Intersection	16.3	B	N/A	17.2	B	N/A	Yes	N/A	
Ponce de Leon Blvd & San Lorenzo Avenue	S	NB	2.3	A	0.19	2.8	A	0.17	Yes	Yes	
		SB	5.7	A	0.25	6.6	A	0.25	Yes	Yes	
		EB	40.4	D	0.47	40.1	D	0.62	Yes	Yes	
		Intersection	5.1	A	N/A	7.0	A	N/A	Yes	N/A	
Bird Road & Salzedo St	U	NB	43.8	E	0.28	51.9	F	0.46	<b>No</b>	<b>Yes</b>	
Bird Road & Aurora St	U	NB	18.7	C	0.19	17.2	C	0.29	Yes	Yes	
Altara Avenue & Aurora St	U	NB	16.4	C	0.12	12.5	B	0.13	Yes	Yes	
		SB	15.2	C	0.22	12.1	B	0.29	Yes	Yes	
Ponce de Leon Blvd & Altara Avenue	U	EB	19.2	C	0.19	25.0	D	0.40	Yes	Yes	
Aurora St & 250 Bird Road (Driveway)	U	EB	9.5	A	0.1	9.5	A	0.1	Yes	Yes	

<sup>1</sup> S = Signalized, U = Un-signalized

**Table 11. Future with Project Arterial Capacity Analysis for AM and PM Peak Hours**

Segment	Direction	Arterial Class	AM Peak Speed	AM Peak LOS	PM Peak Speed	PM Peak LOS	City's LOS Std
Bird Road: b/w Le Jeune Road & Ponce de Leon Blvd	EB	II	9.8	F	13.6	E	E
	WB	II	10.0	E	9.9	F	E
Le Jeune Rd: b/w Bird Road & Altara Avenue	NB	III	8.2	F	9.5	F	E
	SB	III	8.6	F	9.8	F	E
Ponce de Leon Blvd: b/w Bird Road & San Lorenzo Avenue	NB	III	7.7	F	7.5	F	E
	SB	III	10.1	E	9.6	F	E
Altara Avenue: b/w Ponce de Leon Blvd and Le Jeune Road	WB	III	28.3	B	28.3	B	E
	EB	-	-	NA	-	NA	

### 3.5 Multimodal LOS

The multimodal LOS analysis was conducted using the ARTPLAN software. This software takes into account the facility's roadway, traffic, control, and multimodal characteristics to determine the LOS for the automobile, bicycle, pedestrian, and bus modes. The software implements the urban streets methodology describe in Chapter 17 of the HCM. It is important to note that ARTPLAN does not combine the LOS for each of the modes into one overall LOS for the facility since there is no professionally acceptable or scientifically valid technique for combining LOS, instead it calculates an individual LOS for each mode based on common roadway characteristics. **Table 12** and **13** provide the LOS analysis results for automobile, pedestrian, bicycle and bus modes of transportation for existing and future condition, respectively. ARTPLAN output sheets are provided in **Appendix L**.

**Table 12. Existing Conditions Multimodal LOS**

Segment	Mode	LOS Score	Speed (mph)	Multimodal LOS
Bird Road from Le Jeune Road to Ponce de Leon Blvd	Automobile	-	20.23	D
	Pedestrian	4.19	-	D
	Bicyclist	5.44	-	F
	Bus	2.99	-	D
Le Jeune Road from Bird Road to Altara Avenue	Automobile	-	18.26	D
	Pedestrian	3.54	-	D
	Bicyclist	4.56	-	E
	Bus	3.42	-	C
Ponce de Leon Blvd from Bird Road to San Lorenzo Avenue	Automobile	-	11.47	F
	Pedestrian	1.88	-	A
	Bicyclist	6.61	-	F
	Bus	3.82	-	C

**Table 13. Future Conditions Multimodal LOS**

Segment	Mode	LOS Score	Speed (mph)	Multimodal LOS
Bird Road from Le Jeune Road to Ponce de Leon Blvd	Automobile	-	19.69	D
	Pedestrian	4.23	-	D
	Bicyclist	5.45	-	F
	Bus	2.99	-	D
Le Jeune Road from Bird Road to Altara Avenue	Automobile	-	18.20	D
	Pedestrian	3.57	-	D
	Bicyclist	4.57	-	E
	Bus	3.42	-	C
Ponce de Leon Blvd from Bird Road to San Lorenzo Avenue	Automobile	-	11.54	F
	Pedestrian	1.89	-	A
	Bicyclist	6.62	-	F
	Bus	3.82	-	C

The results show that there was not a significant change in the LOS for automobile, pedestrian, bicyclist or bus modes. The multimodal analysis indicated that the quality of service of the analyzed modes would not be adversely impacted by the additional traffic from the proposed development.

### 3.6 Parking Analysis

The estimate of the amount of parking required was calculated using the City of Coral Gables' Zoning Code methodology (Section 5-1409). The zoning code provides a methodology to estimate parking spaces for mixed-use developments that includes estimates of parking spaces per land use, loading spaces, and parking requirement reductions. Parking reductions were applied due to the interaction among different land uses of the mixed-use development. However, no reductions were applied due to the availability of on-street parking or for proximity to or use of transit services. The parking spaces proposed by the developer were compared with the calculated number of parking spaces per the zoning code methodology. The total amount of proposed parking spaces (362) meets the City of Coral Gables' requirements (348 parking spaces) for a mixed-use development. **Table 14** provides the City's minimum parking requirements and **Table 15** provides the total amount of minimum parking required after applying the reduction methodology.

The City requires two loading spaces for mixed-use buildings that exceed a floor area of 199,999 sq. ft. The proposed loading spaces meets the City's requirements as shown in **Table 16**. The City's methodology to estimate the number of parking and loading spaces is provided in **Appendix M**.

**Table 14. Amount of Required Parking as per City of Coral Gables Zoning Code**

Land Use	Size/Units	Minimum Parking Requirements	Minimum Parking Required
Multifamily Housing (Mid-Rise) Land Use Code: 221	215 units	Efficiency and one (1) and bedroom units – 1.0 space per unit. Two (2) bedroom units – 1.75 spaces per unit	265
Office Land Use Code: 710	22,591 SF	One (1) space per three hundred (300) square feet of floor area	76
Retail/Shopping Center Land Use Code: 820	11,840 SF		40
Total Parking Spaces Required			381

**Table 15. City of Coral Gables Shared Parking Analysis**

Land Use	Parking Spaces	Weekday						Weekend					
		Day 8am - 5pm		Evening 5pm - 12am		Night 12am - 8 am		Day 8am - 5pm		Evening 5pm - 12am		Night 12am - 8 am	
		%	Parking Spaces	%	Parking Spaces	%	Parking Spaces	%	Parking Spaces	%	Parking Spaces	%	Parking Spaces
Residential (Shared)	50	60%	30	90%	45	100%	50	80%	40	90%	45	100%	50
Residential (Reserved)	215		215		215		215		215		215		215
Office	76	100%	76	10%	8	5%	4	10%	8	5%	4	5%	4
Retail	40	70%	28	90%	36	5%	2	100%	40	70%	28	5%	2
Total	381		*348		304		271		303		292		271

\*Required Parking: 348 Spaces

**Table 16. Required Loading Spaces**

Nonresidential Floor Area	Required Loading Spaces	Proposed Floor Area	Proposed Loading Spaces
100,000 sq. ft. to 199,999 sq. ft.	One (1)	N/A	N/A
200,000 sq. ft. to 299,999 sq. ft.	Two (2)	221,246 sq. ft.	Two (2)



## 4. CONCLUSION

The purpose of this report was to conduct a traffic impact study for a proposed mixed-use development located in the City of Coral Gables at SR 976/Bird Road (SW 40<sup>th</sup> Street) and Aurora Avenue.

The existing and future LOS were estimated with the aid of Synchro 10, which utilizes the HCM 6<sup>th</sup> Edition methodology. Opening year conditions were based on the results from the trip generation and trip distribution analysis. The results were compared to the City's LOS standard (LOS E) adopted in their Comprehensive Plan.

The Synchro analysis for intersections showed that the proposed mixed-use development will not have a negative impact on adjacent intersections. The existing condition analysis showed that three intersections had approaches that currently operate with a LOS F:

- Northbound Ponce de Leon Boulevard at Bird Road
- Southbound Ponce de Leon Boulevard at Bird Road
- Southbound Le Jeune Road at Bird Road
- Westbound Altara Avenue at Le Jeune Road

The future conditions with committed developments but without the study development maintained a LOS F for the above listed approaches and resulted in a LOS F for the following additional approaches:

- Northbound Le Jeune Road at Bird Road
- Northbound Salzedo St at Bird Road

The analysis for future conditions with the proposed development indicated that same six approaches will continue to operate below the City's LOS standards at LOS F. The remaining intersection approaches in the future with project condition will operate at LOS D or better. The greatest increase in delay due to the new trips generated by the proposed development resulted in only 7 seconds. Similarly, roadway segments would not be negatively impacted by the proposed development; the greatest decrease in segment speed resulted in only 3 percent (3%).

The multimodal analysis computed a LOS E and F for bicycle facilities, this result suggests a lack of bicycle facilities in the area. However, the LOS for bicyclist mode is expected to improve through future projects, which will implement protected bike lanes along Ponce de Leon Boulevard and San Lorenzo Street.

The parking analysis showed that the total amount of proposed parking spaces meets the City of Coral Gables' requirements for a mixed-use development. Please note that the parking generation analysis was conservatively conducted and did not include any reductions for transit or on-street parking.

In addition to the traffic impact analysis, a signal operations and safety clearance check was conducted at existing signalized intersection within the project limits. Pedestrian clearances were evaluated for adequate WALK and FLASHING DON'T WALK intervals to accommodate pedestrians at the study intersections. The assessment indicated that the FLASHING DON'T WALK interval for the eastbound crosswalk at SR 953/Le Jeune Road and San Lorenzo Avenue does not meet the minimum pedestrian clearance interval. Based on MUTCD methodology the FLASHING DON'T WALK interval for the eastbound movement (Phase 8) must be 14 seconds. All other intersections analyzed proved to be adequate for pedestrian mobility.

# APPENDIX A

---

Site Plan

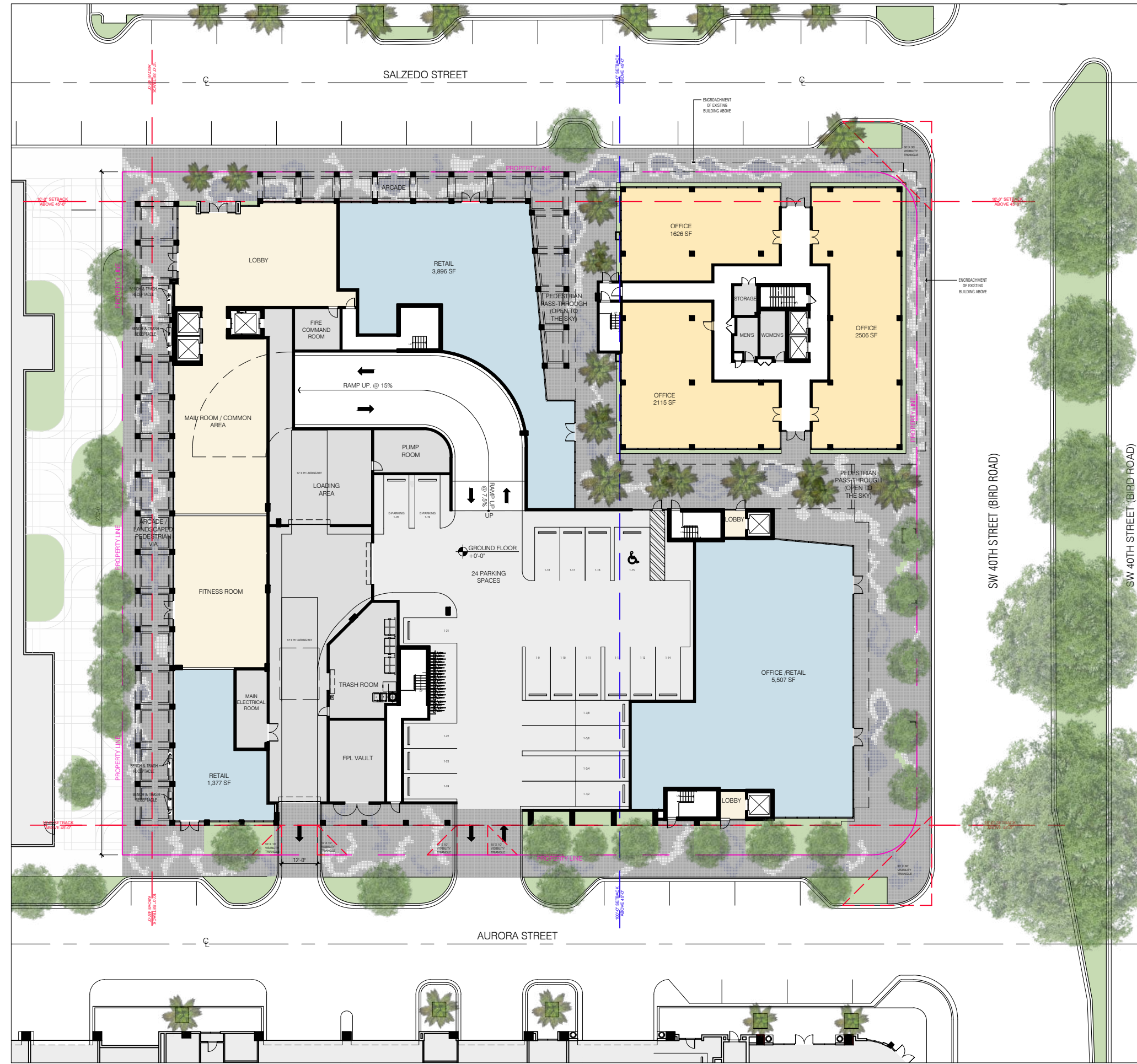

LANDSCAPE OPEN SPACE:	REQUIRED	PROVIDED
		9,285 SF OPEN TO THE SKY
		4,861 SF PROVIDED ARCADE AREA (.75 x 4,861 SF = 3,646 SF)
		9,285 SF + 3,646 SF = 12,931 SF (21.0%)
<b>TOTAL</b>	<b>12,309 SQ.FT. = 20%</b>	<b>LANDSCAPE OPEN SPACE PROVIDED = 12,931 SF (21.0%)</b>

UNIT MATRIX				
LEVEL	STUDIO	1BR	2BR	TOTAL
1ST LEVEL	0	0	0	0
2ND LEVEL	1	2	1	4
3RD LEVEL	1	2	1	4
4TH LEVEL	0	0	0	0
5TH LEVEL (RECREATIONAL)	4	16	4	24
6TH LEVEL	3	14	9	26
7TH LEVEL	3	14	9	26
8TH LEVEL	3	14	9	26
9TH LEVEL	3	14	9	26
10TH LEVEL	3	14	9	26
11TH LEVEL	3	17	7	27
12TH LEVEL	3	14	9	26
<b>TOTALS</b>	<b>27</b>	<b>121</b>	<b>67</b>	<b>215</b>
<b>UNIT MIX</b>	<b>13%</b>	<b>56%</b>	<b>31%</b>	<b>100%</b>

PARKING		REQUIRED	PROVIDED
<b>RESIDENTIAL PARKING</b>			
ST UNITS @ 1.00		1x 27 ST UNITS	27
1BR UNITS @ 1.00		1x 121 1BR UNITS	121.00
2BR UNITS @ 1.75		1.75x 67 2BR UNITS	117.25
		<b>TOTAL (RESIDENTIAL):</b>	<b>265</b>
<b>COMMERCIAL PARKING</b>			
1 SPACE PER 300 SQ.FT			
	EXISTING OFFICE BUILDING	22,591 sq.ft. / 300	76
	GROUND FLOOR COMMERCIAL	10,895 sq.ft. / 300	36
	<b>CITY REQUIRED</b>		<b>21</b>
	<b>TOTAL (RETAIL):</b>		<b>112</b>
	<b>TOTAL</b>		<b>377</b>

PARKING REDUCTION		REQUIRED	PROVIDED
See table for shared parking analysis below			
As per shared parking matrix & Section 5-1410 (B)(2)			
			346
<b>TOTAL PARKING</b>		<b>346</b>	<b>346 + 16 SURPLUS = 362 SPACES</b>

HANDICAPPED PARKING		REQUIRED	PROVIDED
<i>(As per Florida Accessibility Code For Building Const.)</i>			
HANDICAPPED PARKING		7	7
# OF HANDICAPPED SPACES REQUIRED TO BE VAN ACCESSIBLE			
(1 PER 6 REG. HC PARKING SPACES) / 7/6 = 1.16		1.16 = 2	2
<b>TOTAL HANDICAPPED PARKING</b>		<b>7</b>	<b>7</b>

ELECTRIC VEHICLE CHARGING PARKING		REQUIRED	PROVIDED
<i>Section 5-1409 (F)(1)</i>			
2% of the required parking spaces			
	(.02 X 281 = 5.62)	6	8
3% ready	(.03 X 281 = 8.43)	9	12
15% infrastructure ready	(.15 X 281 = 42.15)	43	45
<b>TOTAL =</b>		<b>58</b>	<b>65</b>

LOADING SPACES		REQUIRED	PROVIDED
<i>(As per 5-1409.D City of Coral Gables Zoning Code)</i>			
		(200,000 sq. ft. to 299,999 sq. ft.)	(230,430 sq. ft.)
		2	2

BICYCLE STORAGE SPACES		REQUIRED	PROVIDED
<i>(As per 5-604.B Table 1, City of Coral Gables Zoning Code)</i>			
		10	16

PARKING						
FLOOR	SPACES	HANDICAP	E. CHARGING	TOTAL	TOTAL (WITH LIFTS)	
GROUND FLOOR	21	1	2	24		
2ND LEVEL	79	2	2	83		
3RD LEVEL	103	2	2	107		
4TH LEVEL	94	2	2	98		
POSSIBLE LIFTS	50	0	0		50	
<b>TOTAL</b>		<b>7</b>	<b>4</b>	<b>312</b>	<b>362</b>	

ZONING INFORMATION			
PROJECT NAME:	250 BIRD ROAD		
PROPERTY ADDRESS:	250 BIRD RD CORAL GABLES, FL		
ZONING:	NORTH INDUSTRIAL MXD, COMMERCIAL		
LAND USE:	COMMERCIAL LOW RISE INTENSITY & INDUSTRIAL		
NET LOT AREA:	61,548 SQ.FT. (1.413 ACRES)		

MAXIMUM F.A.R.:	ALLOWED
CORAL GABLES:	61,548 SQ.FT. X 3.0 = 184,644
DEVELOPMENT BONUS STANDARD:	61,548 SQ.FT. X 0.5 = 30,774
ALLOWED F.A.R.	215,418
PURCHASED TDR:	4,904
<b>TOTAL:</b>	<b>220,322</b>

F.A.R.:	AREA	# FLOORS	TOTAL
GROUND	12,453 SQ.FT.	1	
	EXISTING BLDG. GROUND	7,865 SQ.FT.	20,318
2nd LEVEL	3,452 SQ.FT.	1	
	EXISTING BLDG. 2ND	9,527 SQ.FT.	12,979
3rd LEVEL	0 SQ.FT.	1	
4th LEVEL	3,452 SQ.FT.	1	
	EXISTING BLDG. 3RD	9,527 SQ.FT.	12,979
5th REC LEVEL	20,410 SQ.FT.	1	20,410
6th - 10th LEVEL	21,948 SQ.FT.	5	109,740
11th-12th LEVEL	21,948 SQ.FT.	2	43,896
<b>TOTAL</b>			<b>220,322</b>

LOT COVERAGE:		REQUIRED	PROVIDED
		NO MIN. OR MAX.	INCLUDING EXISTING BLDG
			52,746 SQ.FT

MIXED USE PERCENTAGE:		REQUIRED	PROVIDED
	COMMERCIAL:		
	MIN. 8% TOTAL BUILDING SQUARE FOOTAGE OR ENTIRE GROUND FLOOR WHICHEVER IS GREATER	8% OF 220,322 = 17,626 SQ.FT.	18,650 SQ.FT. = 8.46%

HEIGHT:		ALLOWED	PROVIDED
	COMMERCIAL DISTRICT	100'-0"	120'-0" TO ROOF
	INDUSTRIAL DISTRICT	100'-0"	
	*NORTH INDUSTRIAL MXD W/ UNDERLYING INDUSTRIAL ZONING DESIGNATION	ADDITIONAL 20'-0"	130'-4" TO TOP OF ARCHITECTURE
		TOTAL = 120'-0"	*12 STORIES PURSUANT TO PAD APPROVAL

RESIDENTIAL DENSITY:		ALLOWED	PROVIDED
		NO LIMITATION	215 UNITS

SETBACKS:		ALLOWED	PROVIDED
FRONT (BIRD RD):		UP TO 45'-0" : 0'-0"	EXISTING BLDG. UP TO 45'-0" : 0'-0"
			PROPOSED BLDG. ABOVE 45'-0" : N/A
SIDE STREET (SALZEDO ST):		UP TO 45'-0" : 0'-0"	EXISTING BLDG. UP TO 45'-0" : 0'-0"
			PROPOSED BLDG. ABOVE 45'-0" : N/A
SIDE STREET (AURORA ST):		UP TO 45'-0" : 0'-0"	EXISTING BLDG. N/A
			PROPOSED BLDG. UP TO 45'-0" : 10'-0"
INTERIOR SIDE:		0'-0"	EXISTING BLDG. N/A
			PROPOSED BLDG. UP TO 45'-0" : 4'-4"

City of Coral Gables Shared Parking Analysis													
Alta - 250 Bird Road													
Land Use	Parking Spaces	Weekday						Weekend					
		Day		Evening		Night		Day		Evening		Night	
		8am - 5pm	5pm - 12am	5pm - 12am	12am - 8am	8am - 5pm	5pm - 12am	12am - 8am	Percentage	Parking Spaces	Percentage	Parking Spaces	
Residential (Shared)	50	60%	30	90%	45	100%	50	80%	40	90%	45	100%	50
Residential (Reserved)	215	100%	215	100%	215	100%	215	100%	215	100%	215	100%	215
Office	75	100%	75	10%	8	5%	4	10%	8	5%	4	5%	4
Retail	36	70%	25	90%	33	5%	2	100%	36	70%	25	5%	2
Restaurant	0	50%	0	100%	0	10%	0	75%	0	100%	0	10%	0
Hotel	0	80%	0	100%	0	80%	0	80%	0	100%	0	75%	0
Entertainment	0	40%	0	100%	0	10%	0	80%	0	100%	0	10%	0
Other	0	100%	0	100%	0	100%	0	100%	0	100%	0	100%	0
<b>Total</b>	<b>377</b>		<b>346</b>		<b>301</b>		<b>271</b>		<b>300</b>		<b>290</b>		<b>271</b>

**REQUIRED PARKING = 346 SPACES**

**MASTER SITE PLAN**

SCALE: N.T.S.

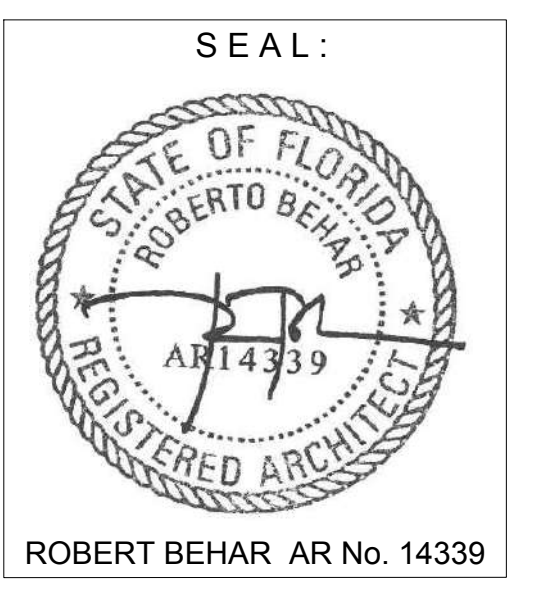

ROBERT BEHAR AR No. 14339

**MERRICK 250**  
250 BIRD RD.  
CORAL GABLES, FL 33146

REVISION 02/07/2020  
REVISION 01/22/2020  
REVISION 12/17/2019  
REVISION 11/18/2019

DATE: 02-07-2020  
PROJECT NO: 19-017  
DRAWING NAME:

SHEET NO:  
**CP-0.1**

© 2019 BEHAR-FONT PARTNERS, P.A. THE DESIGN AND DRAWINGS FOR THIS PROJECT ARE PROPERTY OF THIS ARCHITECT AND ARE PROTECTED UNDER THE COPYRIGHT PROTECTION ACT.

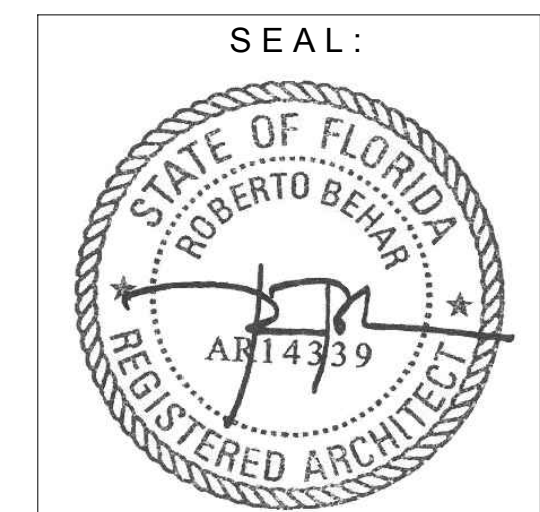

ROBERT BEHAR AR No. 14339

© 2019 BEHAR FONT PARTNERS, P.A. THE DESIGN AND DRAWINGS FOR THIS PROJECT ARE PROPERTY OF THIS ARCHITECT AND ARE PROTECTED UNDER THE COPYRIGHT PROTECTION ACT.

**MERRICK 250**  
250 BIRD RD.  
CORAL GABLES, FL 33146

REVISION 01/22/2020  
REVISION 12/17/2019  
REVISION 11/18/2019

DATE: 12-17-2019  
PROJECT NO: 19-017  
DRAWING NAME:

SHEET NO:  
**CP-0.1**

ZONING INFORMATION			
PROJECT NAME:	250 BIRD ROAD		
PROPERTY ADDRESS:	250 BIRD RD CORAL GABLES, FL		
ZONING:	NORTH INDUSTRIAL MXD, COMMERCIAL		
LAND USE:	COMMERCIAL LOW RISE INTENSITY & INDUSTRIAL		
NET LOT AREA:	61,548 SQ.FT. (1.413 ACRES)		

MAXIMUM F.A.R.:	CORAL GABLES:	61,548	SO.FT. X	3.0	ALLOWED
					184,644
DEVELOPMENT BONUS STANDARD:	61,548	SO.FT. X	0.5		30,774
ALLOWED F.A.R.:					215,418
PURCHASED TDR:					5,828
TOTAL:					221,246

F.A.R.:	AREA	# FLOORS	TOTAL
GROUND	13,428 SQ.FT.	1	
EXISTING BLDG. GROUND	7,864 SQ.FT.		21,292
2nd LEVEL	3,420 SQ.FT.	1	
EXISTING BLDG. 2ND	9,427 SQ.FT.		12,847
3rd LEVEL	0 SQ.FT.	1	
4th LEVEL	3,420 SQ.FT.	1	
EXISTING BLDG. 3RD	9,427 SQ.FT.		12,847
5th REC LEVEL	20,020 SQ.FT.	1	20,020
6th - 10th LEVEL	22,052 SQ.FT.	5	110,260
11th-12TH LEVEL	21,990 SQ.FT.	2	43,980
TOTAL			221,246

LOT COVERAGE:	REQUIRED	PROVIDED
	NO MIN. OR MAX.	INCLUDING EXISTING BLDG
		54,012 SQ.FT

MIXED USE PERCENTAGE:	REQUIRED	PROVIDED
COMMERCIAL:	8% OF 221,694 = 17,735.5 SQ.FT.	19,539 SQ.FT. = 8.81%
MIN. 8% TOTAL BUILDING SQUARE FOOTAGE OR ENTIRE GROUND FLOOR WHICHEVER IS GREATER		

HEIGHT:	ALLOWED	PROVIDED
COMMERCIAL DISTRICT	100'-0"	120'-0" TO ROOF
INDUSTRIAL DISTRICT	100'-0"	
*NORTH INDUSTRIAL MXD W/ UNDERLYING INDUSTRIAL ZONING DESIGNATION	ADDITIONAL 20'-0"	130'-4" TO TOP OF ARCHITECTURE
	TOTAL = 120'-0"	*11 STORIES PURSUANT TO PAD APPROVAL

RESIDENTIAL DENSITY:	ALLOWED	PROVIDED
	NO LIMITATION	215 UNITS

SETBACKS:	ALLOWED	PROVIDED
FRONT (BIRD RD):	UP TO 45'-0": 0'-0"	EXISTING BLDG. UP TO 45'-0": 0'-0"
		PROPOSED BLDG. ABOVE 45'-0": N/A
	ABOVE 45'-0": 100'-0"	UP TO 45'-0": 12'-0"
		PROPOSED BLDG. ABOVE 45'-0": 100'-0"
SIDE STREET (SALZEDO ST):	UP TO 45'-0": 0'-0"	EXISTING BLDG. UP TO 45'-0": 0'-0"
		PROPOSED BLDG. ABOVE 45'-0": N/A
	ABOVE 45'-0": 10'-0"	UP TO 45'-0": 1'-0"
		PROPOSED BLDG. ABOVE 45'-0": 10'-0"
SIDE STREET (AURORA ST):	UP TO 45'-0": 0'-0"	EXISTING BLDG. N/A
		PROPOSED BLDG. N/A
	ABOVE 45'-0": 10'-0"	UP TO 45'-0": 10'-0"
		PROPOSED BLDG. ABOVE 45'-0": 10'-0"
INTERIOR SIDE:	0'-0"	EXISTING BLDG. N/A
		PROPOSED BLDG. UP TO 45'-0": 4'-4"
		PROPOSED BLDG. ABOVE 45'-0": 10'-0"

City of Coral Gables Shared Parking Analysis  
Alta - 250 Bird Road

Land Use	Parking Spaces	Weekday						Weekend					
		Day		Evening		Night		Day		Evening		Night	
		8am - 5pm	5pm - 12am	5pm - 12am	12am - 8am	8am - 5pm	5pm - 12am	12am - 8am	8am - 5pm	5pm - 12am	12am - 8am	12am - 8am	
Residential	265	60%	160	90%	239	100%	266	80%	213	90%	239	100%	266
Office	76	100%	76	10%	8	5%	4	10%	8	5%	4	5%	4
Retail	37	70%	26	90%	34	5%	2	100%	37	70%	26	5%	2
Restaurant	0	50%	0	100%	0	10%	0	75%	0	100%	0	10%	0
Hotel	0	80%	0	100%	0	80%	0	80%	0	100%	0	75%	0
Entertainment	0	40%	0	100%	0	10%	0	80%	0	100%	0	10%	0
Other	0	100%	0	100%	0	100%	0	100%	0	100%	0	100%	0
<b>Total</b>	<b>378</b>		<b>262</b>		<b>281</b>		<b>272</b>		<b>258</b>		<b>269</b>		<b>272</b>

**REQUIRED PARKING = 281 SPACES**

MASTER SITE PLAN

SCALE: N.T.S.

LANDSCAPE OPEN SPACE:	REQUIRED	PROVIDED
	.20 X 61,548 =	9,972 SF OPEN TO THE SKY
		5,013 SF PROVIDED ARCADE AREA (75 x 5,013 SF = 3,509 SF)
		9,972 SF + 3,509 SF = 13,481 SF (20.4%)
TOTAL	12,309 SQ.FT. = 20%	LANDSCAPE OPEN SPACE PROVIDED = 13,481 SF (22%)

UNIT MATRIX				
LEVEL	STUDIO	1BR	2BR	TOTAL
1ST LEVEL	0	0	0	0
2ND LEVEL	1	2	1	4
3RD LEVEL	1	2	1	4
4TH LEVEL	0	0	0	0
5TH LEVEL (RECREATIONAL)	4	16	4	24
6TH LEVEL	3	14	9	26
7TH LEVEL	3	14	9	26
8TH LEVEL	3	14	9	26
9TH LEVEL	3	14	9	26
10TH LEVEL	3	14	9	26
11TH LEVEL	3	17	7	27
12TH LEVEL	3	14	9	26
TOTALS	27	121	67	215
UNIT MIX	13%	56%	31%	100%

PARKING	REQUIRED	PROVIDED
<b>RESIDENTIAL PARKING</b>		
ST UNITS @ 1.00	1x 27 ST UNITS:	27
1BR UNITS @ 1.00	1x121 1BR UNITS:	121.00
2BR UNITS @ 1.75	1.75x67 2BR UNITS:	117.25
	TOTAL (RESIDENTIAL):	265
<b>COMMERCIAL PARKING</b>		
1 SPACE PER 300 SQ.FT		
EXISTING OFFICE BUILDING	22,591 sq.ft. / 300	76
GROUND FLOOR COMMERCIAL	10,895 sq.ft. / 300	36
CITY REQUIRED		21
	TOTAL (RETAIL):	112
	TOTAL	377
<b>PARKING REDUCTION</b>		281
See table for shared parking analysis below		
As per shared parking matrix & Section 5-1410 (B)(2)		
<b>TOTAL PARKING</b>	<b>281</b>	<b>281 + 86 SURPLUS = 367 SPACES</b>

HANDICAPPED PARKING	REQUIRED	PROVIDED
(As per Florida Accessibility Code For Building Const.)		
HANDICAPPED PARKING	7	7
# OF HANDICAPPED SPACES REQUIRED TO BE VAN ACCESSIBLE		
(1 PER 6 REQ. HC PARKING SPACES) 7/6 = 1.16	1.16 = 2	2
TOTAL HANDICAPPED PARKING	7	7

ELECTRIC VEHICLE CHARGING PARKING	REQUIRED	PROVIDED
Section 5-1409 (F)(1)		
2% of the required parking spaces	(.02 X 281 = 5.62)	6
3% ready	(.03 X 281 = 8.43)	9
15% infrastructure ready	(.15 X 281 = 42.15)	43
TOTAL =	58	65

LOADING SPACES	REQUIRED	PROVIDED
(As per 5-1409.D City of Coral Gables Zoning Code)	(200,000 sq. ft. to 299,999 sq. ft.)	(230,430 sq. ft.)
	2	2

BICYCLE STORAGE SPACES	REQUIRED	PROVIDED
(As per 5-604.B Table 1, City of Coral Gables Zoning Code)	10	16

PARKING	SPACES	HANDICAP	E. CHARGING	TOTAL	TOTAL (WITH LIFTS)
GROUND FLOOR	15	1	2	18	
2ND LEVEL	77	2	2	86	
3RD LEVEL	106	2	2	111	
4TH LEVEL	106	2	2	112	
POSSIBLE LIFTS	50	0	0		50
TOTAL		7	8	317	367

LEGAL DESCRIPTION:  
LOTS 1 THROUGH 11, INCLUSIVE, LESS THE SOUTH 7.5 FEET THEREOF, AND LOTS 32 THROUGH 42, INCLUSIVE, LESS THE SOUTH 7.5 FEET THEREOF, BLOCK 3, "CORAL GABLES INDUSTRIAL SECTION", ACCORDING TO THE PLAT THEREOF AS RECORDED IN PLAT BOOK 28 AT PAGE 22, OF THE PUBLIC RECORDS OF MIAMI-DADE COUNTY FLORIDA.

TOGETHER WITH:

THAT PORTION OF THE 30 FOOT PLATTED ALLEY LYING NORTH OF THE NORTH LINE OF THE SOUTH 7.5 FEET OF SAID LOT 11 PROJECTED WESTERLY AND SOUTH OF THE NORTH LINE OF SAID BLOCK 3.

Note: Original "Older" Version of Site Plan provided for which the land use square footage was calculated for this study.

# APPENDIX B

---

## Vehicular Traffic Counts

## Seventy Two-Hour Vehicular Traffic Counts

---

A & P Consulting Transportation  
 10305 Nw 41St St., Suite 115  
 Miami, Florida, United States 33178  
 (305)592-7283 edsanchez@apcte.com

Count Name: SR 976Bird Road between SR  
 953LeJeune Road and Ponce De Leon  
 Boulevard Wednesday  
 Site Code: SR 976Bird Road between SR  
 953LeJeune Road and Pon  
 Start Date: 01/22/2020  
 Page No: 1

**Direction (Westbound)**

Start Time	Lights	Buses	Trucks	Total
01/22/2020 12:00 AM	55	0	0	55
12:15 AM	58	0	0	58
12:30 AM	39	0	1	40
12:45 AM	37	0	1	38
1:00 AM	29	0	0	29
1:15 AM	35	0	2	37
1:30 AM	22	0	0	22
1:45 AM	22	0	0	22
2:00 AM	17	0	0	17
2:15 AM	19	0	0	19
2:30 AM	17	0	1	18
2:45 AM	14	0	1	15
3:00 AM	13	0	0	13
3:15 AM	7	0	0	7
3:30 AM	16	0	1	17
3:45 AM	14	0	0	14
4:00 AM	22	0	0	22
4:15 AM	28	0	0	28
4:30 AM	20	0	0	20
4:45 AM	30	0	1	31
5:00 AM	32	0	2	34
5:15 AM	40	1	1	42
5:30 AM	63	0	1	64
5:45 AM	74	1	0	75
6:00 AM	111	2	1	114
6:15 AM	147	0	1	148
6:30 AM	182	7	4	193
6:45 AM	226	5	0	231
7:00 AM	258	2	0	260
7:15 AM	218	2	0	220
7:30 AM	226	2	3	231
7:45 AM	289	2	3	294
8:00 AM	298	2	3	303
8:15 AM	295	5	4	304
8:30 AM	319	6	7	332
8:45 AM	296	2	6	304
9:00 AM	258	2	8	268
9:15 AM	232	2	5	239
9:30 AM	270	0	5	275
9:45 AM	270	2	6	278
10:00 AM	246	1	10	257



10:15 AM  
10:30 AM  
10:45 AM  
11:00 AM  
11:15 AM  
11:30 AM  
11:45 AM  
12:00 PM  
12:15 PM  
12:30 PM  
12:45 PM  
1:00 PM  
1:15 PM  
1:30 PM  
1:45 PM  
2:00 PM  
2:15 PM  
2:30 PM  
2:45 PM  
3:00 PM  
3:15 PM  
3:30 PM  
3:45 PM  
4:00 PM  
4:15 PM  
4:30 PM  
4:45 PM  
5:00 PM  
5:15 PM  
5:30 PM  
5:45 PM  
6:00 PM  
6:15 PM  
6:30 PM  
6:45 PM  
7:00 PM  
7:15 PM  
7:30 PM  
7:45 PM  
8:00 PM  
8:15 PM  
8:30 PM  
8:45 PM  
9:00 PM  
9:15 PM  
9:30 PM  
9:45 PM  
10:00 PM  
10:15 PM  
10:30 PM  
10:45 PM  
11:00 PM

209	2	9	220
246	2	6	254
254	2	8	264
251	0	8	259
273	2	6	281
281	1	9	291
265	4	8	277
274	1	7	282
290	1	7	298
305	2	8	315
275	2	11	288
290	3	9	302
301	1	14	316
280	3	3	286
290	3	9	302
293	4	8	305
306	4	8	318
301	4	5	310
260	3	5	268
310	1	5	316
391	4	8	403
392	3	11	406
357	2	5	364
384	1	2	387
388	5	8	401
421	2	3	426
365	1	5	371
418	2	4	424
421	3	4	428
432	1	2	435
412	1	2	415
426	2	5	433
425	0	5	430
420	3	3	426
398	1	0	399
404	1	1	406
428	1	0	429
323	2	1	326
239	1	0	240
290	0	0	290
226	5	2	233
236	0	0	236
203	0	2	205
213	0	0	213
187	2	0	189
154	0	0	154
170	0	0	170
150	0	0	150
170	2	2	174
145	0	0	145
158	0	0	158
155	0	0	155

11:15 PM	124	1	1	126
11:30 PM	84	0	0	84
11:45 PM	74	0	0	74
Total	20601	137	307	21045
Total %	97.9	0.7	1.5	100.0
AM Times	7:45 AM	6:30 AM	10:00 AM	7:45 AM
AM Peaks	1201	16	33	1233
PM Times	6:00 PM	2:00 PM	12:30 PM	6:00 PM
PM Peaks	1669	15	42	1688

A & P Consulting Transportation  
 10305 Nw 41St St., Suite 115  
 Miami, Florida, United States 33178  
 (305)592-7283 edsanchez@apcte.com

Count Name: SR 976Bird Road between SR  
 953LeJeune Road and Ponce De Leon  
 Boulevard Wednesday  
 Site Code: SR 976Bird Road between SR  
 953LeJeune Road and Pon  
 Start Date: 01/22/2020  
 Page No: 4

**Direction (Eastbound)**

Start Time	Lights	Buses	Trucks	Total
01/22/2020 12:00 AM	38	0	1	39
12:15 AM	28	0	0	28
12:30 AM	38	0	0	38
12:45 AM	25	0	0	25
1:00 AM	23	0	1	24
1:15 AM	22	0	0	22
1:30 AM	17	0	1	18
1:45 AM	9	0	0	9
2:00 AM	12	0	0	12
2:15 AM	11	0	0	11
2:30 AM	11	0	1	12
2:45 AM	14	0	0	14
3:00 AM	7	0	1	8
3:15 AM	13	0	0	13
3:30 AM	8	0	1	9
3:45 AM	19	0	0	19
4:00 AM	15	0	0	15
4:15 AM	35	0	0	35
4:30 AM	36	0	0	36
4:45 AM	41	1	0	42
5:00 AM	46	0	0	46
5:15 AM	80	0	4	84
5:30 AM	129	1	1	131
5:45 AM	223	2	1	226
6:00 AM	214	0	2	216
6:15 AM	286	6	4	296
6:30 AM	321	4	7	332
6:45 AM	281	12	3	296
7:00 AM	277	1	5	283
7:15 AM	307	5	5	317
7:30 AM	308	2	7	317
7:45 AM	327	1	10	338
8:00 AM	325	2	10	337
8:15 AM	334	1	4	339
8:30 AM	318	1	8	327
8:45 AM	303	3	5	311
9:00 AM	377	2	7	386
9:15 AM	361	1	14	376
9:30 AM	349	2	13	364
9:45 AM	351	2	9	362
10:00 AM	336	0	12	348

10:15 AM  
10:30 AM  
10:45 AM  
11:00 AM  
11:15 AM  
11:30 AM  
11:45 AM  
12:00 PM  
12:15 PM  
12:30 PM  
12:45 PM  
1:00 PM  
1:15 PM  
1:30 PM  
1:45 PM  
2:00 PM  
2:15 PM  
2:30 PM  
2:45 PM  
3:00 PM  
3:15 PM  
3:30 PM  
3:45 PM  
4:00 PM  
4:15 PM  
4:30 PM  
4:45 PM  
5:00 PM  
5:15 PM  
5:30 PM  
5:45 PM  
6:00 PM  
6:15 PM  
6:30 PM  
6:45 PM  
7:00 PM  
7:15 PM  
7:30 PM  
7:45 PM  
8:00 PM  
8:15 PM  
8:30 PM  
8:45 PM  
9:00 PM  
9:15 PM  
9:30 PM  
9:45 PM  
10:00 PM  
10:15 PM  
10:30 PM  
10:45 PM  
11:00 PM

350	2	11	363
263	0	15	278
345	2	8	355
315	1	13	329
268	1	4	273
310	1	7	318
298	0	8	306
278	3	7	288
305	2	10	317
301	1	7	309
338	2	8	348
289	3	7	299
283	1	8	292
270	2	6	278
284	3	8	295
297	2	3	302
257	12	3	272
308	11	3	322
308	5	3	316
291	4	4	299
293	3	4	300
310	1	3	314
292	2	3	297
303	3	2	308
272	1	3	276
279	2	2	283
276	2	2	280
255	1	2	258
262	1	3	266
238	1	0	239
255	2	1	258
307	2	2	311
311	2	0	313
269	1	0	270
275	2	1	278
255	1	1	257
236	1	2	239
246	0	0	246
242	1	1	244
202	1	0	203
189	1	0	190
190	0	0	190
162	0	0	162
167	2	0	169
170	0	0	170
131	0	1	132
146	0	0	146
122	1	0	123
131	1	0	132
105	0	0	105
105	0	0	105
89	1	0	90

11:15 PM	60	0	0	60
11:30 PM	61	0	1	62
11:45 PM	32	0	0	32
Total	19471	143	314	19928
Total %	97.7	0.7	1.6	100.0
AM Times	7:45 AM	6:30 AM	10:00 AM	7:45 AM
AM Peaks	1304	22	46	1341
PM Times	6:00 PM	2:00 PM	12:30 PM	6:00 PM
PM Peaks	1162	30	30	1172

A & P Consulting Transportation  
10305 Nw 41St St., Suite 115  
Miami, Florida, United States 33178  
(305)592-7283 edsanchez@apcte.com

Count Name: SR 976Bird Road between SR  
953LeJeune Road and Ponce De Leon  
Boulevard Wednesday  
Site Code: SR 976Bird Road between SR  
953LeJeune Road and Pon  
Start Date: 01/22/2020  
Page No: 7

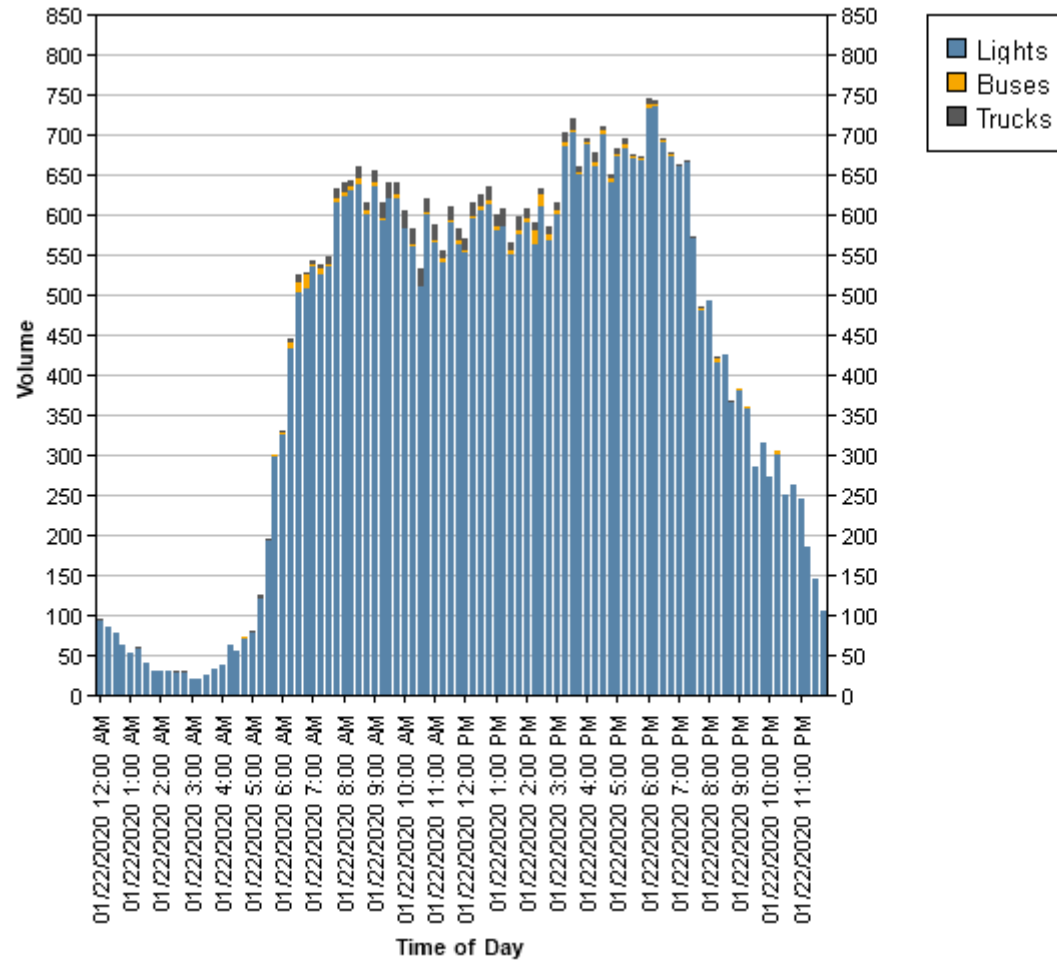

A & P Consulting Transportation  
10305 Nw 41St St., Suite 115  
Miami, Florida, United States 33178  
(305)592-7283 edsanchez@apcte.com

Count Name: SR 976Bird Road between SR  
953LeJeune Road and Ponce De Leon  
Boulevard Wednesday  
Site Code: SR 976Bird Road between SR  
953LeJeune Road and Pon  
Start Date: 01/22/2020  
Page No: 8

A & P Consulting Transportation  
 10305 Nw 41St St., Suite 115  
 Miami, Florida, United States 33178  
 (305)592-7283 edsanchez@apcte.com

Count Name: SR 976Bird Road between SR  
 953LeJeune Road and Ponce De Leon  
 Boulevard Thursday  
 Site Code: SR 976Bird Road between SR  
 953LeJeune Road and Pon  
 Start Date: 01/23/2020  
 Page No: 1

**Direction (Westbound)**

Start Time	Lights	Buses	Trucks	Total
01/23/2020 12:00 AM	70	0	0	70
12:15 AM	65	0	0	65
12:30 AM	50	0	0	50
12:45 AM	43	0	0	43
1:00 AM	39	0	0	39
1:15 AM	29	0	1	30
1:30 AM	34	0	0	34
1:45 AM	27	0	1	28
2:00 AM	29	0	1	30
2:15 AM	23	0	1	24
2:30 AM	28	0	0	28
2:45 AM	15	0	1	16
3:00 AM	11	0	1	12
3:15 AM	11	0	0	11
3:30 AM	17	0	0	17
3:45 AM	12	0	1	13
4:00 AM	21	0	2	23
4:15 AM	19	0	2	21
4:30 AM	32	0	0	32
4:45 AM	35	0	1	36
5:00 AM	43	0	2	45
5:15 AM	34	1	3	38
5:30 AM	70	0	0	70
5:45 AM	60	1	1	62
6:00 AM	103	1	1	105
6:15 AM	136	1	3	140
6:30 AM	167	8	1	176
6:45 AM	235	5	1	241
7:00 AM	238	3	1	242
7:15 AM	228	0	2	230
7:30 AM	242	3	9	254
7:45 AM	281	1	4	286
8:00 AM	279	3	6	288
8:15 AM	324	7	5	336
8:30 AM	298	5	5	308
8:45 AM	295	2	6	303
9:00 AM	233	1	6	240
9:15 AM	268	3	15	286
9:30 AM	213	1	4	218
9:45 AM	237	3	4	244
10:00 AM	245	1	5	251



10:15 AM  
 10:30 AM  
 10:45 AM  
 11:00 AM  
 11:15 AM  
 11:30 AM  
 11:45 AM  
 12:00 PM  
 12:15 PM  
 12:30 PM  
 12:45 PM  
 1:00 PM  
 1:15 PM  
 1:30 PM  
 1:45 PM  
 2:00 PM  
 2:15 PM  
 2:30 PM  
 2:45 PM  
 3:00 PM  
 3:15 PM  
 3:30 PM  
 3:45 PM  
 4:00 PM  
 4:15 PM  
 4:30 PM  
 4:45 PM  
 5:00 PM  
 5:15 PM  
 5:30 PM  
 5:45 PM  
 6:00 PM  
 6:15 PM  
 6:30 PM  
 6:45 PM  
 7:00 PM  
 7:15 PM  
 7:30 PM  
 7:45 PM  
 8:00 PM  
 8:15 PM  
 8:30 PM  
 8:45 PM  
 9:00 PM  
 9:15 PM  
 9:30 PM  
 9:45 PM  
 10:00 PM  
 10:15 PM  
 10:30 PM  
 10:45 PM  
 11:00 PM

238	1	5	244
231	4	10	245
246	5	7	258
248	0	7	255
255	2	9	266
239	3	9	251
284	2	7	293
275	0	6	281
299	1	7	307
277	1	9	287
247	1	12	260
290	2	9	301
270	2	3	275
308	2	5	315
290	2	10	302
304	5	6	315
296	5	5	306
300	4	6	310
312	3	10	325
340	1	12	353
371	1	7	379
356	2	4	362
359	2	7	368
355	2	5	362
350	6	4	360
360	2	3	365
346	3	4	353
413	1	2	416
399	2	6	407
426	2	3	431
339	3	4	346
351	1	7	359
402	2	1	405
380	2	9	391
348	2	5	355
380	3	1	384
395	0	3	398
275	1	1	277
257	1	3	261
253	1	1	255
267	3	2	272
257	0	4	261
216	0	3	219
153	0	4	157
167	0	5	172
171	1	3	175
170	0	1	171
175	0	2	177
147	2	2	151
163	0	1	164
131	0	2	133
121	0	1	122

11:15 PM	132	1	0	133
11:30 PM	88	0	0	88
11:45 PM	97	0	0	97
Total	19958	142	360	20460
Total %	97.5	0.7	1.8	100.0
AM Times	7:45 AM	6:15 AM	10:00 AM	7:45 AM
AM Peaks	1182	17	27	1218
PM Times	5:00 PM	2:00 PM	12:15 PM	5:00 PM
PM Peaks	1577	17	37	1600

A & P Consulting Transportation  
 10305 Nw 41St St., Suite 115  
 Miami, Florida, United States 33178  
 (305)592-7283 edsanchez@apcte.com

Count Name: SR 976Bird Road between SR  
 953LeJeune Road and Ponce De Leon  
 Boulevard Thursday  
 Site Code: SR 976Bird Road between SR  
 953LeJeune Road and Pon  
 Start Date: 01/23/2020  
 Page No: 4

**Direction (Eastbound)**

Start Time	Lights	Buses	Trucks	Total
01/23/2020 12:00 AM	42	0	0	42
12:15 AM	29	0	1	30
12:30 AM	30	0	0	30
12:45 AM	33	0	0	33
1:00 AM	23	0	0	23
1:15 AM	25	0	1	26
1:30 AM	25	0	0	25
1:45 AM	13	0	0	13
2:00 AM	11	0	1	12
2:15 AM	18	0	1	19
2:30 AM	9	0	0	9
2:45 AM	10	0	3	13
3:00 AM	10	0	0	10
3:15 AM	10	0	0	10
3:30 AM	13	0	0	13
3:45 AM	19	0	2	21
4:00 AM	23	0	1	24
4:15 AM	27	0	1	28
4:30 AM	34	0	0	34
4:45 AM	44	1	1	46
5:00 AM	58	0	1	59
5:15 AM	96	0	2	98
5:30 AM	145	2	4	151
5:45 AM	201	1	4	206
6:00 AM	206	2	5	213
6:15 AM	249	4	5	258
6:30 AM	257	0	6	263
6:45 AM	231	11	6	248
7:00 AM	273	3	6	282
7:15 AM	281	5	5	291
7:30 AM	314	2	8	324
7:45 AM	364	2	7	373
8:00 AM	376	2	5	383
8:15 AM	387	2	8	397
8:30 AM	332	3	3	338
8:45 AM	299	2	2	303
9:00 AM	346	0	7	353
9:15 AM	356	1	10	367
9:30 AM	358	2	10	370
9:45 AM	368	1	6	375
10:00 AM	359	0	19	378

10:15 AM  
 10:30 AM  
 10:45 AM  
 11:00 AM  
 11:15 AM  
 11:30 AM  
 11:45 AM  
 12:00 PM  
 12:15 PM  
 12:30 PM  
 12:45 PM  
 1:00 PM  
 1:15 PM  
 1:30 PM  
 1:45 PM  
 2:00 PM  
 2:15 PM  
 2:30 PM  
 2:45 PM  
 3:00 PM  
 3:15 PM  
 3:30 PM  
 3:45 PM  
 4:00 PM  
 4:15 PM  
 4:30 PM  
 4:45 PM  
 5:00 PM  
 5:15 PM  
 5:30 PM  
 5:45 PM  
 6:00 PM  
 6:15 PM  
 6:30 PM  
 6:45 PM  
 7:00 PM  
 7:15 PM  
 7:30 PM  
 7:45 PM  
 8:00 PM  
 8:15 PM  
 8:30 PM  
 8:45 PM  
 9:00 PM  
 9:15 PM  
 9:30 PM  
 9:45 PM  
 10:00 PM  
 10:15 PM  
 10:30 PM  
 10:45 PM  
 11:00 PM

310	3	12	325
318	1	9	328
343	1	14	358
318	0	13	331
293	1	10	304
288	2	9	299
309	0	8	317
298	1	3	302
302	1	8	311
264	1	10	275
303	4	4	311
310	0	7	317
293	1	7	301
296	1	9	306
254	4	4	262
261	2	9	272
232	8	2	242
304	11	3	318
280	4	4	288
280	3	6	289
282	2	3	287
278	3	1	282
293	1	5	299
311	5	1	317
267	1	7	275
286	2	4	292
274	1	3	278
289	2	3	294
285	1	3	289
342	2	3	347
288	2	5	295
278	1	2	281
324	2	1	327
316	1	4	321
268	2	5	275
240	0	4	244
256	0	2	258
208	2	4	214
215	0	3	218
168	0	0	168
254	0	2	256
182	0	3	185
150	0	1	151
161	2	1	164
144	0	3	147
145	0	3	148
135	0	2	137
124	0	2	126
140	0	0	140
128	0	0	128
129	0	3	132
100	1	0	101

11:15 PM	92	0	0	92
11:30 PM	70	0	3	73
11:45 PM	61	0	0	61
Total	19643	128	378	20149
Total %	97.5	0.6	1.9	100.0
AM Times	7:45 AM	6:15 AM	10:00 AM	7:45 AM
AM Peaks	1459	18	54	1491
PM Times	5:00 PM	2:00 PM	12:15 PM	5:00 PM
PM Peaks	1204	25	29	1225

A & P Consulting Transportation  
10305 Nw 41St St., Suite 115  
Miami, Florida, United States 33178  
(305)592-7283 edsanchez@apcte.com

Count Name: SR 976Bird Road between SR  
953LeJeune Road and Ponce De Leon  
Boulevard Thursday  
Site Code: SR 976Bird Road between SR  
953LeJeune Road and Pon  
Start Date: 01/23/2020  
Page No: 7

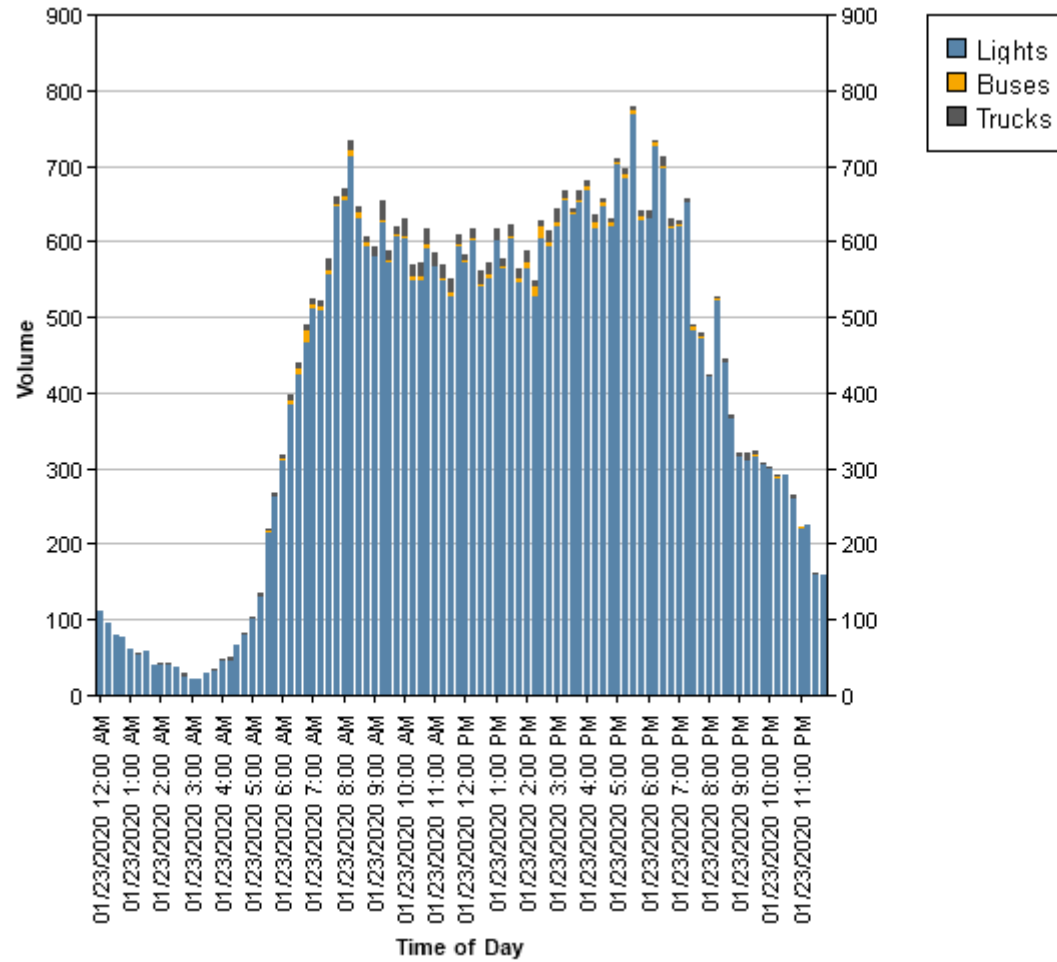

A & P Consulting Transportation  
10305 Nw 41St St., Suite 115  
Miami, Florida, United States 33178  
(305)592-7283 edsanchez@apcte.com

Count Name: SR 976Bird Road between SR  
953LeJeune Road and Ponce De Leon  
Boulevard Thursday  
Site Code: SR 976Bird Road between SR  
953LeJeune Road and Pon  
Start Date: 01/23/2020  
Page No: 8

A & P Consulting Transportation  
 10305 Nw 41St St., Suite 115  
 Miami, Florida, United States 33178  
 (305)592-7283 edsanchez@apcte.com

Count Name: SR 976Bird Road between SR  
 953LeJeune Road and Ponce De Leon  
 Boulevard FC West Tuesday  
 Site Code: SR 976Bird Road between SR  
 953LeJeune Road and Pon  
 Start Date: 01/21/2020  
 Page No: 1

**Direction (Westbound)**

Start Time	Lights	Buses	Trucks	Total
01/21/2020 12:00 AM	55	0	2	57
12:15 AM	43	0	0	43
12:30 AM	33	0	0	33
12:45 AM	30	0	0	30
1:00 AM	30	0	0	30
1:15 AM	23	0	1	24
1:30 AM	27	0	0	27
1:45 AM	26	0	0	26
2:00 AM	19	0	0	19
2:15 AM	15	0	0	15
2:30 AM	12	0	0	12
2:45 AM	22	0	0	22
3:00 AM	14	0	1	15
3:15 AM	20	0	1	21
3:30 AM	14	0	0	14
3:45 AM	18	0	0	18
4:00 AM	18	0	0	18
4:15 AM	17	0	0	17
4:30 AM	17	0	1	18
4:45 AM	43	0	2	45
5:00 AM	27	1	1	29
5:15 AM	47	1	1	49
5:30 AM	68	0	0	68
5:45 AM	78	1	0	79
6:00 AM	107	0	2	109
6:15 AM	122	1	3	126
6:30 AM	175	5	5	185
6:45 AM	173	6	2	181
7:00 AM	260	4	3	267
7:15 AM	242	0	2	244
7:30 AM	243	2	1	246
7:45 AM	276	1	6	283
8:00 AM	283	4	4	291
8:15 AM	283	8	4	295
8:30 AM	315	3	5	323
8:45 AM	301	4	8	313
9:00 AM	234	6	2	242
9:15 AM	260	4	2	266
9:30 AM	226	8	4	238
9:45 AM	276	8	4	288
10:00 AM	206	2	5	213



10:15 AM  
10:30 AM  
10:45 AM  
11:00 AM  
11:15 AM  
11:30 AM  
11:45 AM  
12:00 PM  
12:15 PM  
12:30 PM  
12:45 PM  
1:00 PM  
1:15 PM  
1:30 PM  
1:45 PM  
2:00 PM  
2:15 PM  
2:30 PM  
2:45 PM  
3:00 PM  
3:15 PM  
3:30 PM  
3:45 PM  
4:00 PM  
4:15 PM  
4:30 PM  
4:45 PM  
5:00 PM  
5:15 PM  
5:30 PM  
5:45 PM  
6:00 PM  
6:15 PM  
6:30 PM  
6:45 PM  
7:00 PM  
7:15 PM  
7:30 PM  
7:45 PM  
8:00 PM  
8:15 PM  
8:30 PM  
8:45 PM  
9:00 PM  
9:15 PM  
9:30 PM  
9:45 PM  
10:00 PM  
10:15 PM  
10:30 PM  
10:45 PM  
11:00 PM

236	2	9	247
254	3	7	264
272	2	13	287
249	1	10	260
271	2	7	280
259	0	2	261
278	2	6	286
278	0	5	283
290	2	9	301
287	1	11	299
300	2	10	312
284	3	12	299
259	2	5	266
306	4	6	316
300	2	5	307
296	4	7	307
339	5	5	349
311	2	4	317
340	1	6	347
330	4	9	343
377	3	9	389
374	0	2	376
363	3	6	372
380	1	5	386
398	4	6	408
396	1	2	399
386	4	4	394
436	1	5	442
435	2	1	438
439	3	1	443
359	3	2	364
428	2	1	431
403	1	1	405
402	1	4	407
381	3	0	384
410	2	0	412
339	0	1	340
336	2	0	338
275	1	1	277
282	2	0	284
242	3	0	245
215	0	0	215
213	0	0	213
209	0	1	210
163	2	1	166
188	0	0	188
166	0	0	166
148	0	0	148
122	2	0	124
110	0	0	110
109	0	0	109
130	0	1	131

11:15 PM	137	1	0	138
11:30 PM	89	0	0	89
11:45 PM	67	0	0	67
Total	20344	160	274	20778
Total %	97.9	0.8	1.3	100.0
AM Times	8:00 AM	6:15 AM	10:30 AM	8:00 AM
AM Peaks	1182	16	37	1222
PM Times	4:45 PM	2:15 PM	12:30 PM	4:45 PM
PM Peaks	1696	12	38	1717

A & P Consulting Transportation  
 10305 Nw 41St St., Suite 115  
 Miami, Florida, United States 33178  
 (305)592-7283 edsanchez@apcte.com

Count Name: SR 976Bird Road between SR  
 953LeJeune Road and Ponce De Leon  
 Boulevard FC West Tuesday  
 Site Code: SR 976Bird Road between SR  
 953LeJeune Road and Pon  
 Start Date: 01/21/2020  
 Page No: 4

**Direction (Eastbound)**

Start Time	Lights	Buses	Trucks	Total
01/21/2020 12:00 AM	27	0	1	28
12:15 AM	33	0	0	33
12:30 AM	29	0	1	30
12:45 AM	14	0	0	14
1:00 AM	23	0	2	25
1:15 AM	12	0	1	13
1:30 AM	17	0	0	17
1:45 AM	7	0	0	7
2:00 AM	13	0	0	13
2:15 AM	12	0	0	12
2:30 AM	14	0	0	14
2:45 AM	9	0	0	9
3:00 AM	13	0	2	15
3:15 AM	12	0	1	13
3:30 AM	12	0	1	13
3:45 AM	14	0	0	14
4:00 AM	19	0	1	20
4:15 AM	19	0	1	20
4:30 AM	30	0	0	30
4:45 AM	34	0	2	36
5:00 AM	52	2	1	55
5:15 AM	90	0	2	92
5:30 AM	124	1	3	128
5:45 AM	236	1	2	239
6:00 AM	204	0	2	206
6:15 AM	321	4	5	330
6:30 AM	320	1	5	326
6:45 AM	278	13	3	294
7:00 AM	273	3	7	283
7:15 AM	289	5	9	303
7:30 AM	312	1	4	317
7:45 AM	392	2	7	401
8:00 AM	363	1	7	371
8:15 AM	380	1	8	389
8:30 AM	384	2	7	393
8:45 AM	392	0	13	405
9:00 AM	373	1	9	383
9:15 AM	382	0	6	388
9:30 AM	355	2	8	365
9:45 AM	372	2	5	379
10:00 AM	347	2	13	362

10:15 AM  
 10:30 AM  
 10:45 AM  
 11:00 AM  
 11:15 AM  
 11:30 AM  
 11:45 AM  
 12:00 PM  
 12:15 PM  
 12:30 PM  
 12:45 PM  
 1:00 PM  
 1:15 PM  
 1:30 PM  
 1:45 PM  
 2:00 PM  
 2:15 PM  
 2:30 PM  
 2:45 PM  
 3:00 PM  
 3:15 PM  
 3:30 PM  
 3:45 PM  
 4:00 PM  
 4:15 PM  
 4:30 PM  
 4:45 PM  
 5:00 PM  
 5:15 PM  
 5:30 PM  
 5:45 PM  
 6:00 PM  
 6:15 PM  
 6:30 PM  
 6:45 PM  
 7:00 PM  
 7:15 PM  
 7:30 PM  
 7:45 PM  
 8:00 PM  
 8:15 PM  
 8:30 PM  
 8:45 PM  
 9:00 PM  
 9:15 PM  
 9:30 PM  
 9:45 PM  
 10:00 PM  
 10:15 PM  
 10:30 PM  
 10:45 PM  
 11:00 PM

272	2	4	278
305	1	14	320
325	2	16	343
280	4	11	295
311	0	11	322
265	1	6	272
319	0	8	327
310	1	7	318
304	2	7	313
305	1	9	315
320	2	9	331
287	1	2	290
279	2	14	295
294	1	5	300
305	1	5	311
277	3	7	287
243	7	4	254
296	13	4	313
298	3	4	305
290	4	4	298
288	1	3	292
327	2	4	333
306	0	4	310
281	7	4	292
302	2	0	304
278	1	2	281
302	1	2	305
265	1	1	267
329	2	2	333
307	2	0	309
301	2	0	303
250	1	2	253
275	1	2	278
271	2	0	273
264	2	1	267
243	0	1	244
236	2	0	238
237	1	0	238
237	0	1	238
189	2	0	191
182	0	1	183
206	0	0	206
187	0	0	187
153	1	0	154
150	1	1	152
154	0	0	154
143	0	0	143
128	2	0	130
130	0	0	130
94	0	0	94
108	0	0	108
67	1	1	69

11:15 PM	63	0	0	63
11:30 PM	60	0	0	60
11:45 PM	49	0	0	49
Total	19849	132	322	20303
Total %	97.8	0.7	1.6	100.0
AM Times	8:00 AM	6:15 AM	10:30 AM	8:00 AM
AM Peaks	1519	21	52	1558
PM Times	4:45 PM	2:15 PM	12:30 PM	4:45 PM
PM Peaks	1203	27	34	1214

A & P Consulting Transportation  
10305 Nw 41St St., Suite 115  
Miami, Florida, United States 33178  
(305)592-7283 edsanchez@apcte.com

Count Name: SR 976Bird Road between SR  
953LeJeune Road and Ponce De Leon  
Boulevard FC West Tuesday  
Site Code: SR 976Bird Road between SR  
953LeJeune Road and Pon  
Start Date: 01/21/2020  
Page No: 7

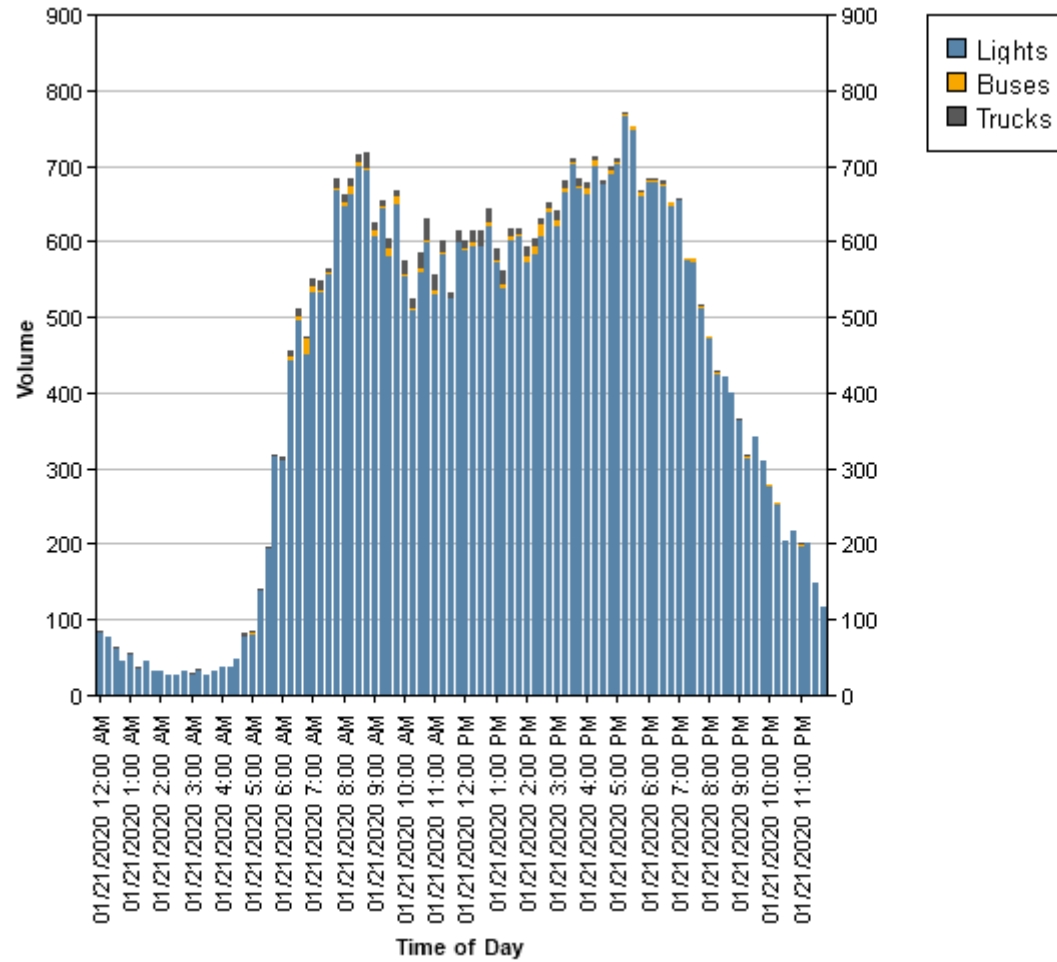

A & P Consulting Transportation  
10305 Nw 41St St., Suite 115  
Miami, Florida, United States 33178  
(305)592-7283 edsanchez@apcte.com

Count Name: SR 976Bird Road between SR  
953LeJeune Road and Ponce De Leon  
Boulevard FC West Tuesday  
Site Code: SR 976Bird Road between SR  
953LeJeune Road and Pon  
Start Date: 01/21/2020  
Page No: 8

A & P Consulting Transportation  
 10305 Nw 41St St., Suite 115  
 Miami, Florida, United States 33178  
 (305)592-7283 edsanchez@apcte.com

Count Name: SR 953LeJeune Road between  
 Altara Avenue and SR 976Bird Road  
 Wednesday  
 Site Code: SR 953LeJeune Road between  
 Altara Avenue and SR 97  
 Start Date: 01/22/2020  
 Page No: 1

**Direction (Southbound)**

Start Time	Lights	Buses	Trucks	Total
01/22/2020 12:00 AM	21	0	0	21
12:15 AM	24	0	0	24
12:30 AM	16	0	1	17
12:45 AM	13	0	0	13
1:00 AM	10	0	0	10
1:15 AM	9	0	0	9
1:30 AM	8	0	0	8
1:45 AM	3	0	2	5
2:00 AM	8	0	0	8
2:15 AM	4	0	0	4
2:30 AM	1	0	0	1
2:45 AM	1	0	0	1
3:00 AM	0	0	1	1
3:15 AM	3	0	0	3
3:30 AM	7	0	1	8
3:45 AM	7	0	2	9
4:00 AM	8	0	0	8
4:15 AM	10	0	1	11
4:30 AM	12	0	2	14
4:45 AM	21	0	2	23
5:00 AM	19	0	3	22
5:15 AM	28	0	0	28
5:30 AM	56	0	0	56
5:45 AM	84	0	3	87
6:00 AM	81	1	0	82
6:15 AM	126	2	2	130
6:30 AM	203	1	2	206
6:45 AM	210	1	3	214
7:00 AM	144	1	2	147
7:15 AM	147	0	0	147
7:30 AM	130	1	2	133
7:45 AM	133	1	3	137
8:00 AM	173	0	3	176
8:15 AM	164	0	3	167
8:30 AM	157	2	5	164
8:45 AM	145	0	7	152
9:00 AM	203	0	4	207
9:15 AM	211	0	6	217
9:30 AM	181	1	2	184
9:45 AM	182	1	6	189
10:00 AM	183	0	6	189



10:15 AM  
10:30 AM  
10:45 AM  
11:00 AM  
11:15 AM  
11:30 AM  
11:45 AM  
12:00 PM  
12:15 PM  
12:30 PM  
12:45 PM  
1:00 PM  
1:15 PM  
1:30 PM  
1:45 PM  
2:00 PM  
2:15 PM  
2:30 PM  
2:45 PM  
3:00 PM  
3:15 PM  
3:30 PM  
3:45 PM  
4:00 PM  
4:15 PM  
4:30 PM  
4:45 PM  
5:00 PM  
5:15 PM  
5:30 PM  
5:45 PM  
6:00 PM  
6:15 PM  
6:30 PM  
6:45 PM  
7:00 PM  
7:15 PM  
7:30 PM  
7:45 PM  
8:00 PM  
8:15 PM  
8:30 PM  
8:45 PM  
9:00 PM  
9:15 PM  
9:30 PM  
9:45 PM  
10:00 PM  
10:15 PM  
10:30 PM  
10:45 PM  
11:00 PM

140	1	10	151
171	2	4	177
160	0	7	167
177	0	9	186
136	1	8	145
143	0	5	148
180	0	1	181
187	0	4	191
200	0	4	204
188	1	1	190
216	0	3	219
198	0	4	202
177	0	2	179
203	1	3	207
190	1	6	197
184	0	7	191
164	2	3	169
209	1	5	215
223	3	5	231
233	2	4	239
251	1	0	252
249	0	1	250
227	1	6	234
261	2	1	264
200	1	4	205
233	1	2	236
277	0	0	277
246	0	0	246
278	0	0	278
277	1	1	279
268	0	0	268
310	0	0	310
295	0	0	295
270	1	1	272
290	0	1	291
239	0	0	239
253	0	1	254
210	0	0	210
180	2	0	182
150	0	0	150
124	1	0	125
116	0	0	116
103	0	0	103
90	0	0	90
109	0	0	109
84	0	0	84
95	0	0	95
82	0	0	82
77	0	0	77
63	0	0	63
89	0	0	89
53	0	0	53

11:15 PM	44	0	0	44
11:30 PM	37	0	0	37
11:45 PM	36	0	0	36
Total	12991	38	187	13216
Total %	98.3	0.3	1.4	100.0
AM Times	9:00 AM	8:00 AM	10:00 AM	9:00 AM
AM Peaks	777	2	27	797
PM Times	6:00 PM	2:15 PM	1:15 PM	3:30 PM
PM Peaks	1165	8	18	953

A & P Consulting Transportation  
 10305 Nw 41St St., Suite 115  
 Miami, Florida, United States 33178  
 (305)592-7283 edsanchez@apcte.com

Count Name: SR 953LeJeune Road between  
 Altara Avenue and SR 976Bird Road  
 Wednesday  
 Site Code: SR 953LeJeune Road between  
 Altara Avenue and SR 97  
 Start Date: 01/22/2020  
 Page No: 4

**Direction (Northbound)**

Start Time	Lights	Buses	Trucks	Total
01/22/2020 12:00 AM	37	0	0	37
12:15 AM	24	0	0	24
12:30 AM	14	0	0	14
12:45 AM	15	0	0	15
1:00 AM	20	0	0	20
1:15 AM	5	0	0	5
1:30 AM	7	0	1	8
1:45 AM	9	0	0	9
2:00 AM	6	0	0	6
2:15 AM	3	0	0	3
2:30 AM	6	0	0	6
2:45 AM	8	0	0	8
3:00 AM	3	0	0	3
3:15 AM	5	0	1	6
3:30 AM	8	0	1	9
3:45 AM	5	0	0	5
4:00 AM	4	0	0	4
4:15 AM	12	0	0	12
4:30 AM	10	0	1	11
4:45 AM	23	0	1	24
5:00 AM	16	0	1	17
5:15 AM	28	0	1	29
5:30 AM	37	0	1	38
5:45 AM	50	0	0	50
6:00 AM	63	0	3	66
6:15 AM	81	0	1	82
6:30 AM	110	1	2	113
6:45 AM	138	0	2	140
7:00 AM	129	0	3	132
7:15 AM	167	0	1	168
7:30 AM	157	1	4	162
7:45 AM	164	0	1	165
8:00 AM	148	1	1	150
8:15 AM	125	0	1	126
8:30 AM	180	1	2	183
8:45 AM	165	4	0	169
9:00 AM	222	1	3	226
9:15 AM	182	0	7	189
9:30 AM	182	1	5	188
9:45 AM	198	0	5	203
10:00 AM	194	0	12	206

10:15 AM  
 10:30 AM  
 10:45 AM  
 11:00 AM  
 11:15 AM  
 11:30 AM  
 11:45 AM  
 12:00 PM  
 12:15 PM  
 12:30 PM  
 12:45 PM  
 1:00 PM  
 1:15 PM  
 1:30 PM  
 1:45 PM  
 2:00 PM  
 2:15 PM  
 2:30 PM  
 2:45 PM  
 3:00 PM  
 3:15 PM  
 3:30 PM  
 3:45 PM  
 4:00 PM  
 4:15 PM  
 4:30 PM  
 4:45 PM  
 5:00 PM  
 5:15 PM  
 5:30 PM  
 5:45 PM  
 6:00 PM  
 6:15 PM  
 6:30 PM  
 6:45 PM  
 7:00 PM  
 7:15 PM  
 7:30 PM  
 7:45 PM  
 8:00 PM  
 8:15 PM  
 8:30 PM  
 8:45 PM  
 9:00 PM  
 9:15 PM  
 9:30 PM  
 9:45 PM  
 10:00 PM  
 10:15 PM  
 10:30 PM  
 10:45 PM  
 11:00 PM

174	0	8	182
177	1	5	183
183	0	6	189
177	0	7	184
166	1	5	172
167	0	7	174
171	0	0	171
197	0	6	203
201	0	7	208
184	1	9	194
184	0	9	193
179	0	4	183
193	1	8	202
193	0	10	203
188	0	16	204
190	1	2	193
195	1	5	201
190	0	7	197
205	0	8	213
237	1	5	243
225	1	6	232
257	0	7	264
265	0	1	266
229	2	4	235
286	0	4	290
235	2	2	239
205	0	7	212
220	0	6	226
233	0	1	234
214	1	0	215
189	0	4	193
207	0	0	207
206	0	0	206
210	0	0	210
191	0	1	192
163	0	5	168
169	0	0	169
163	0	0	163
180	1	0	181
197	1	0	198
131	0	0	131
138	0	1	139
118	1	0	119
153	0	0	153
126	0	0	126
96	0	1	97
104	0	0	104
90	0	0	90
79	0	2	81
74	0	0	74
52	0	0	52
75	1	0	76

11:15 PM	53	0	0	53
11:30 PM	35	0	0	35
11:45 PM	29	0	0	29
Total	12308	27	247	12582
Total %	97.8	0.2	2.0	100.0
AM Times	9:00 AM	8:00 AM	10:00 AM	9:00 AM
AM Peaks	784	6	31	806
PM Times	6:00 PM	2:15 PM	1:15 PM	3:30 PM
PM Peaks	814	2	36	1055

A & P Consulting Transportation  
10305 Nw 41St St., Suite 115  
Miami, Florida, United States 33178  
(305)592-7283 edsanchez@apcte.com

Count Name: SR 953LeJeune Road between  
Altara Avenue and SR 976Bird Road  
Wednesday  
Site Code: SR 953LeJeune Road between  
Altara Avenue and SR 97  
Start Date: 01/22/2020  
Page No: 7

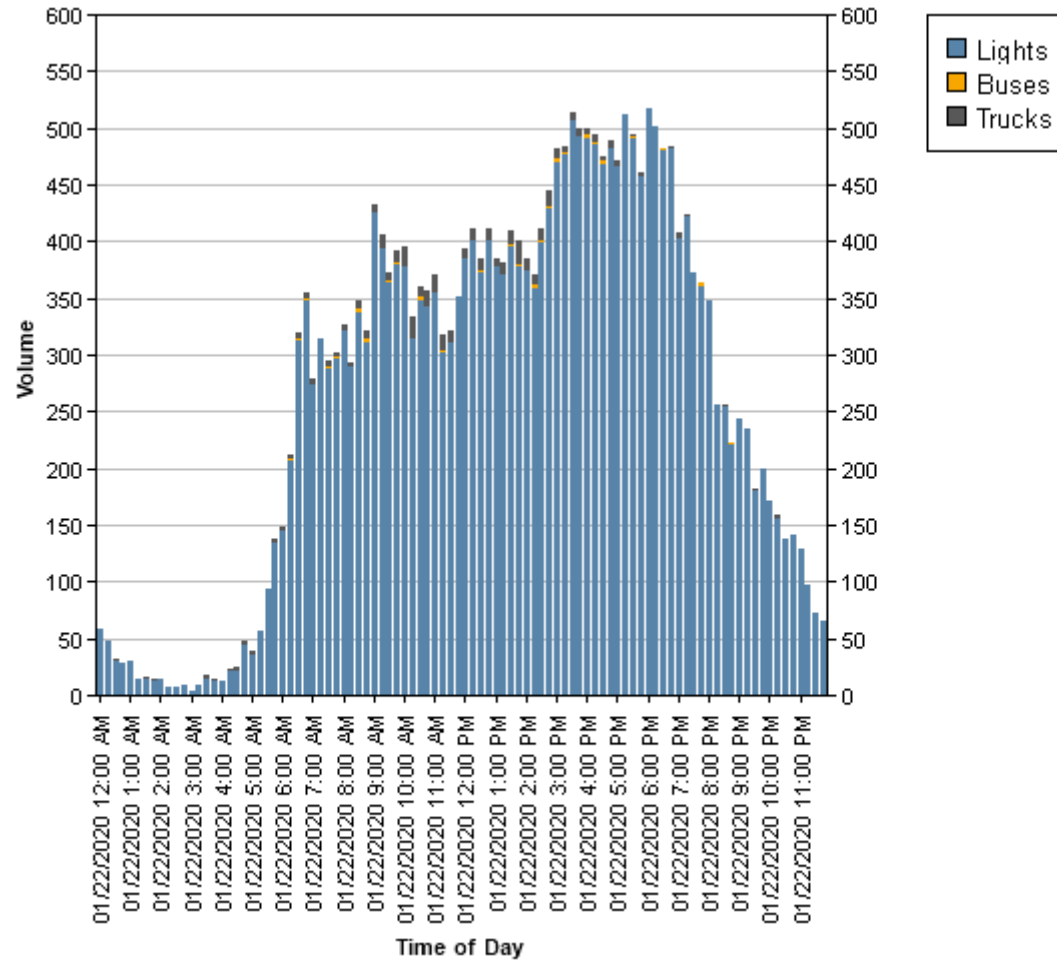

A & P Consulting Transportation  
10305 Nw 41St St., Suite 115  
Miami, Florida, United States 33178  
(305)592-7283 edsanchez@apcte.com

Count Name: SR 953LeJeune Road between  
Altara Avenue and SR 976Bird Road  
Wednesday  
Site Code: SR 953LeJeune Road between  
Altara Avenue and SR 97  
Start Date: 01/22/2020  
Page No: 8

A & P Consulting Transportation  
 10305 Nw 41St St., Suite 115  
 Miami, Florida, United States 33178  
 (305)592-7283 edsanchez@apcte.com

Count Name: SR 953LeJeune Road between  
 Altara Avenue and SR 976Bird Road Tuesday  
 Site Code: SR 953LeJeune Road between  
 Altara Avenue and SR 97  
 Start Date: 01/21/2020  
 Page No: 1

**Direction (Southbound)**

Start Time	Lights	Buses	Trucks	Total
01/21/2020 12:00 AM	26	0	0	26
12:15 AM	22	0	0	22
12:30 AM	15	0	1	16
12:45 AM	15	0	0	15
1:00 AM	12	0	0	12
1:15 AM	7	0	0	7
1:30 AM	10	0	0	10
1:45 AM	5	0	0	5
2:00 AM	7	0	1	8
2:15 AM	7	0	0	7
2:30 AM	2	0	1	3
2:45 AM	4	0	0	4
3:00 AM	9	0	0	9
3:15 AM	5	0	0	5
3:30 AM	3	0	1	4
3:45 AM	10	0	1	11
4:00 AM	7	0	0	7
4:15 AM	9	0	0	9
4:30 AM	11	0	1	12
4:45 AM	22	0	2	24
5:00 AM	27	0	0	27
5:15 AM	35	0	1	36
5:30 AM	70	0	4	74
5:45 AM	117	1	5	123
6:00 AM	93	1	1	95
6:15 AM	121	2	2	125
6:30 AM	202	2	1	205
6:45 AM	209	1	2	212
7:00 AM	209	1	3	213
7:15 AM	191	0	3	194
7:30 AM	184	2	6	192
7:45 AM	225	1	9	235
8:00 AM	219	0	7	226
8:15 AM	235	3	2	240
8:30 AM	232	2	6	240
8:45 AM	254	1	8	263
9:00 AM	192	0	9	201
9:15 AM	193	0	9	202
9:30 AM	191	1	7	199
9:45 AM	181	1	8	190
10:00 AM	167	1	12	180
10:15 AM	147	0	7	154



10:30 AM  
10:45 AM  
11:00 AM  
11:15 AM  
11:30 AM  
11:45 AM  
12:00 PM  
12:15 PM  
12:30 PM  
12:45 PM  
1:00 PM  
1:15 PM  
1:30 PM  
1:45 PM  
2:00 PM  
2:15 PM  
2:30 PM  
2:45 PM  
3:00 PM  
3:15 PM  
3:30 PM  
3:45 PM  
4:00 PM  
4:15 PM  
4:30 PM  
4:45 PM  
5:00 PM  
5:15 PM  
5:30 PM  
5:45 PM  
6:00 PM  
6:15 PM  
6:30 PM  
6:45 PM  
7:00 PM  
7:15 PM  
7:30 PM  
7:45 PM  
8:00 PM  
8:15 PM  
8:30 PM  
8:45 PM  
9:00 PM  
9:15 PM  
9:30 PM  
9:45 PM  
10:00 PM  
10:15 PM  
10:30 PM  
10:45 PM  
11:00 PM  
11:15 PM

193	3	10	206
183	0	2	185
163	0	5	168
154	0	5	159
180	1	5	186
195	0	6	201
196	0	7	203
181	0	6	187
183	1	1	185
212	0	5	217
193	2	5	200
192	0	5	197
202	3	3	208
179	0	9	188
188	0	4	192
156	2	2	160
216	2	7	225
229	1	3	233
176	5	2	183
228	3	1	232
260	1	3	264
228	0	6	234
239	2	6	247
250	1	1	252
273	2	1	276
270	1	0	271
255	0	1	256
288	0	1	289
256	1	0	257
311	0	0	311
274	1	2	277
276	0	0	276
281	1	0	282
235	0	0	235
234	0	0	234
233	1	0	234
203	1	1	205
162	0	0	162
143	0	0	143
110	0	0	110
108	0	0	108
132	0	0	132
111	0	0	111
76	0	0	76
74	0	0	74
85	0	1	86
63	0	0	63
59	0	0	59
51	0	0	51
45	0	0	45
36	0	0	36
41	0	0	41

11:30 PM	19	0	0	19
11:45 PM	21	0	0	21
Total	13403	55	236	13694
Total %	97.9	0.4	1.7	100.0
AM Times	8:00 AM	7:30 AM	9:45 AM	8:00 AM
AM Peaks	940	6	37	969
PM Times	5:00 PM	2:30 PM	1:15 PM	5:00 PM
PM Peaks	1110	11	21	1113

A & P Consulting Transportation  
 10305 Nw 41St St., Suite 115  
 Miami, Florida, United States 33178  
 (305)592-7283 edsanchez@apcte.com

Count Name: SR 953LeJeune Road between  
 Altara Avenue and SR 976Bird Road Tuesday  
 Site Code: SR 953LeJeune Road between  
 Altara Avenue and SR 97  
 Start Date: 01/21/2020  
 Page No: 4

**Direction (Northbound)**

Start Time	Lights	Buses	Trucks	Total
01/21/2020 12:00 AM	27	0	0	27
12:15 AM	16	0	0	16
12:30 AM	14	0	1	15
12:45 AM	9	0	0	9
1:00 AM	13	0	0	13
1:15 AM	10	0	0	10
1:30 AM	8	0	0	8
1:45 AM	4	0	0	4
2:00 AM	2	0	0	2
2:15 AM	8	0	0	8
2:30 AM	6	0	0	6
2:45 AM	3	0	0	3
3:00 AM	4	0	0	4
3:15 AM	5	0	0	5
3:30 AM	9	0	2	11
3:45 AM	7	0	0	7
4:00 AM	8	0	1	9
4:15 AM	11	0	0	11
4:30 AM	20	0	1	21
4:45 AM	22	0	0	22
5:00 AM	27	0	2	29
5:15 AM	34	0	1	35
5:30 AM	47	0	1	48
5:45 AM	62	0	1	63
6:00 AM	60	0	1	61
6:15 AM	67	0	2	69
6:30 AM	112	2	0	114
6:45 AM	131	0	3	134
7:00 AM	154	0	0	154
7:15 AM	167	0	2	169
7:30 AM	164	1	4	169
7:45 AM	172	2	3	177
8:00 AM	203	2	4	209
8:15 AM	196	1	4	201
8:30 AM	218	1	6	225
8:45 AM	221	2	9	232
9:00 AM	215	1	8	224
9:15 AM	206	0	4	210
9:30 AM	185	1	6	192
9:45 AM	210	1	3	214
10:00 AM	202	0	11	213
10:15 AM	219	0	5	224

10:30 AM  
 10:45 AM  
 11:00 AM  
 11:15 AM  
 11:30 AM  
 11:45 AM  
 12:00 PM  
 12:15 PM  
 12:30 PM  
 12:45 PM  
 1:00 PM  
 1:15 PM  
 1:30 PM  
 1:45 PM  
 2:00 PM  
 2:15 PM  
 2:30 PM  
 2:45 PM  
 3:00 PM  
 3:15 PM  
 3:30 PM  
 3:45 PM  
 4:00 PM  
 4:15 PM  
 4:30 PM  
 4:45 PM  
 5:00 PM  
 5:15 PM  
 5:30 PM  
 5:45 PM  
 6:00 PM  
 6:15 PM  
 6:30 PM  
 6:45 PM  
 7:00 PM  
 7:15 PM  
 7:30 PM  
 7:45 PM  
 8:00 PM  
 8:15 PM  
 8:30 PM  
 8:45 PM  
 9:00 PM  
 9:15 PM  
 9:30 PM  
 9:45 PM  
 10:00 PM  
 10:15 PM  
 10:30 PM  
 10:45 PM  
 11:00 PM  
 11:15 PM

189	1	6	196
199	0	6	205
187	0	8	195
171	0	5	176
165	1	12	178
175	0	7	182
164	0	8	172
203	0	6	209
195	1	9	205
172	0	6	178
185	0	7	192
156	0	12	168
190	3	7	200
198	2	2	202
192	0	10	202
190	1	2	193
203	0	5	208
205	0	2	207
207	1	5	213
233	1	5	239
241	1	2	244
231	1	6	238
266	2	1	269
245	1	4	250
218	0	6	224
219	3	4	226
236	0	4	240
224	0	4	228
229	1	2	232
216	0	1	217
200	0	2	202
166	0	0	166
183	0	2	185
167	1	1	169
176	0	1	177
157	0	1	158
128	0	3	131
127	0	0	127
137	0	1	138
115	0	0	115
108	0	0	108
129	1	0	130
141	0	1	142
130	1	0	131
99	0	0	99
74	0	0	74
84	0	0	84
87	0	1	88
53	0	0	53
50	0	0	50
51	0	0	51
48	0	1	49

11:30 PM	38	0	0	38
11:45 PM	30	0	1	31
Total	12260	37	264	12561
Total %	97.6	0.3	2.1	100.0
AM Times	8:00 AM	7:30 AM	9:45 AM	8:00 AM
AM Peaks	838	6	25	867
PM Times	5:00 PM	2:30 PM	1:15 PM	5:00 PM
PM Peaks	905	2	31	917

A & P Consulting Transportation  
10305 Nw 41St St., Suite 115  
Miami, Florida, United States 33178  
(305)592-7283 edsanchez@apcte.com

Count Name: SR 953LeJeune Road between  
Altara Avenue and SR 976Bird Road Tuesday  
Site Code: SR 953LeJeune Road between  
Altara Avenue and SR 97  
Start Date: 01/21/2020  
Page No: 7

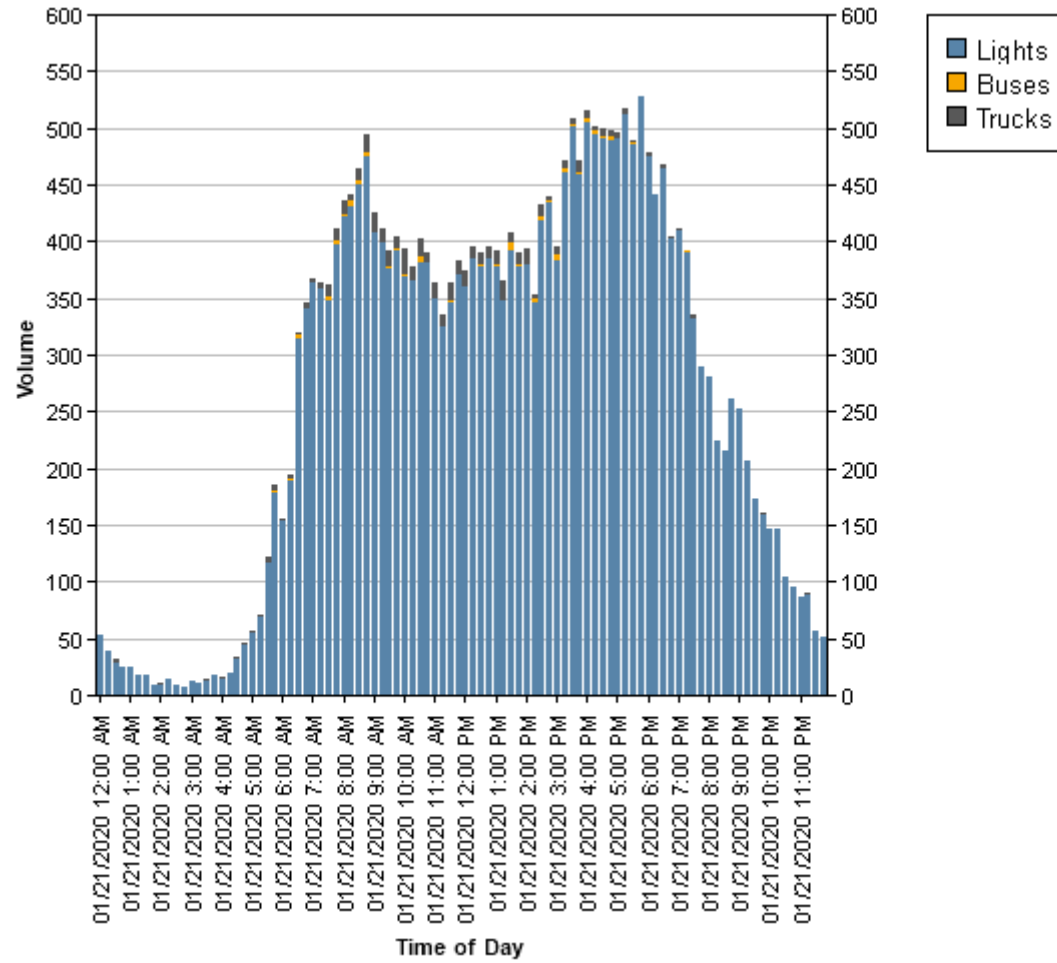

A & P Consulting Transportation  
10305 Nw 41St St., Suite 115  
Miami, Florida, United States 33178  
(305)592-7283 edsanchez@apcte.com

Count Name: SR 953LeJeune Road between  
Altara Avenue and SR 976Bird Road Tuesday  
Site Code: SR 953LeJeune Road between  
Altara Avenue and SR 97  
Start Date: 01/21/2020  
Page No: 8

A & P Consulting Transportation  
 10305 Nw 41St St., Suite 115  
 Miami, Florida, United States 33178  
 (305)592-7283 edsanchez@apcte.com

Count Name: SR 953LeJeune Road between  
 Altara Avenue and SR 976Bird Road Thursday  
 Site Code: SR 953LeJeune Road between  
 Altara Avenue and SR 97  
 Start Date: 01/23/2020  
 Page No: 1

**Direction (Southbound)**

Start Time	Lights	Buses	Trucks	Total
01/23/2020 12:00 AM	24	0	0	24
12:15 AM	17	0	0	17
12:30 AM	25	0	0	25
12:45 AM	15	0	0	15
1:00 AM	10	0	0	10
1:15 AM	13	0	2	15
1:30 AM	10	0	0	10
1:45 AM	12	0	1	13
2:00 AM	12	0	1	13
2:15 AM	6	0	0	6
2:30 AM	9	0	0	9
2:45 AM	11	0	1	12
3:00 AM	6	0	2	8
3:15 AM	6	0	0	6
3:30 AM	6	0	0	6
3:45 AM	8	0	0	8
4:00 AM	5	0	1	6
4:15 AM	10	0	0	10
4:30 AM	15	0	1	16
4:45 AM	13	0	1	14
5:00 AM	17	0	4	21
5:15 AM	33	0	2	35
5:30 AM	66	0	2	68
5:45 AM	98	0	2	100
6:00 AM	95	2	2	99
6:15 AM	137	1	1	139
6:30 AM	190	2	2	194
6:45 AM	203	0	2	205
7:00 AM	200	2	0	202
7:15 AM	196	0	3	199
7:30 AM	157	3	4	164
7:45 AM	223	2	4	229
8:00 AM	228	0	4	232
8:15 AM	244	3	6	253
8:30 AM	216	2	4	222
8:45 AM	235	0	10	245
9:00 AM	203	0	5	208
9:15 AM	199	0	8	207
9:30 AM	199	2	7	208
9:45 AM	193	0	8	201
10:00 AM	172	0	7	179
10:15 AM	168	0	4	172



10:30 AM  
 10:45 AM  
 11:00 AM  
 11:15 AM  
 11:30 AM  
 11:45 AM  
 12:00 PM  
 12:15 PM  
 12:30 PM  
 12:45 PM  
 1:00 PM  
 1:15 PM  
 1:30 PM  
 1:45 PM  
 2:00 PM  
 2:15 PM  
 2:30 PM  
 2:45 PM  
 3:00 PM  
 3:15 PM  
 3:30 PM  
 3:45 PM  
 4:00 PM  
 4:15 PM  
 4:30 PM  
 4:45 PM  
 5:00 PM  
 5:15 PM  
 5:30 PM  
 5:45 PM  
 6:00 PM  
 6:15 PM  
 6:30 PM  
 6:45 PM  
 7:00 PM  
 7:15 PM  
 7:30 PM  
 7:45 PM  
 8:00 PM  
 8:15 PM  
 8:30 PM  
 8:45 PM  
 9:00 PM  
 9:15 PM  
 9:30 PM  
 9:45 PM  
 10:00 PM  
 10:15 PM  
 10:30 PM  
 10:45 PM  
 11:00 PM  
 11:15 PM

170	2	9	181
187	1	7	195
167	0	7	174
174	0	3	177
192	1	3	196
193	0	8	201
169	0	7	176
207	1	4	212
178	1	4	183
197	0	7	204
194	0	4	198
189	1	5	195
202	2	2	206
198	1	1	200
170	1	4	175
156	2	2	160
210	1	7	218
218	0	5	223
198	4	6	208
245	2	0	247
248	1	2	251
256	3	3	262
211	0	2	213
233	0	4	237
227	0	2	229
243	0	0	243
247	0	4	251
262	0	1	263
255	1	0	256
269	0	1	270
254	1	0	255
261	0	0	261
251	1	2	254
233	0	1	234
167	0	0	167
203	0	1	204
195	0	1	196
161	1	0	162
135	0	1	136
135	0	0	135
116	0	0	116
105	0	2	107
90	1	0	91
93	0	0	93
94	1	0	95
77	0	0	77
87	0	0	87
63	0	0	63
78	0	0	78
90	1	0	91
58	0	0	58
33	0	0	33

11:30 PM	33	1	0	34
11:45 PM	38	0	0	38
Total	13220	51	223	13494
Total %	98.0	0.4	1.7	100.0
AM Times	8:00 AM	8:00 AM	11:00 AM	8:00 AM
AM Peaks	923	5	21	952
PM Times	5:00 PM	3:00 PM	12:00 PM	3:30 PM
PM Peaks	1033	10	22	963

A & P Consulting Transportation  
 10305 Nw 41St St., Suite 115  
 Miami, Florida, United States 33178  
 (305)592-7283 edsanchez@apcte.com

Count Name: SR 953LeJeune Road between  
 Altara Avenue and SR 976Bird Road Thursday  
 Site Code: SR 953LeJeune Road between  
 Altara Avenue and SR 97  
 Start Date: 01/23/2020  
 Page No: 4

**Direction (Northbound)**

Start Time	Lights	Buses	Trucks	Total
01/23/2020 12:00 AM	15	0	0	15
12:15 AM	20	0	0	20
12:30 AM	20	0	0	20
12:45 AM	15	0	0	15
1:00 AM	7	0	0	7
1:15 AM	15	0	0	15
1:30 AM	13	0	0	13
1:45 AM	2	0	1	3
2:00 AM	5	0	0	5
2:15 AM	8	0	0	8
2:30 AM	7	0	0	7
2:45 AM	9	0	1	10
3:00 AM	5	0	0	5
3:15 AM	3	0	0	3
3:30 AM	7	0	1	8
3:45 AM	6	0	0	6
4:00 AM	5	0	0	5
4:15 AM	9	0	1	10
4:30 AM	14	0	1	15
4:45 AM	17	0	0	17
5:00 AM	21	0	0	21
5:15 AM	31	1	2	34
5:30 AM	46	0	1	47
5:45 AM	56	0	1	57
6:00 AM	69	0	2	71
6:15 AM	79	0	4	83
6:30 AM	106	2	1	109
6:45 AM	131	0	1	132
7:00 AM	150	0	1	151
7:15 AM	158	0	5	163
7:30 AM	154	1	2	157
7:45 AM	159	0	2	161
8:00 AM	194	2	5	201
8:15 AM	197	1	3	201
8:30 AM	200	3	3	206
8:45 AM	213	3	4	220
9:00 AM	212	0	1	213
9:15 AM	200	0	2	202
9:30 AM	167	0	5	172
9:45 AM	210	1	0	211
10:00 AM	169	5	0	174
10:15 AM	191	4	3	198

10:30 AM  
 10:45 AM  
 11:00 AM  
 11:15 AM  
 11:30 AM  
 11:45 AM  
 12:00 PM  
 12:15 PM  
 12:30 PM  
 12:45 PM  
 1:00 PM  
 1:15 PM  
 1:30 PM  
 1:45 PM  
 2:00 PM  
 2:15 PM  
 2:30 PM  
 2:45 PM  
 3:00 PM  
 3:15 PM  
 3:30 PM  
 3:45 PM  
 4:00 PM  
 4:15 PM  
 4:30 PM  
 4:45 PM  
 5:00 PM  
 5:15 PM  
 5:30 PM  
 5:45 PM  
 6:00 PM  
 6:15 PM  
 6:30 PM  
 6:45 PM  
 7:00 PM  
 7:15 PM  
 7:30 PM  
 7:45 PM  
 8:00 PM  
 8:15 PM  
 8:30 PM  
 8:45 PM  
 9:00 PM  
 9:15 PM  
 9:30 PM  
 9:45 PM  
 10:00 PM  
 10:15 PM  
 10:30 PM  
 10:45 PM  
 11:00 PM  
 11:15 PM

174	1	6	181
200	1	5	206
173	1	4	178
163	0	4	167
181	1	9	191
176	0	12	188
173	0	5	178
147	1	1	149
203	1	6	210
190	0	3	193
217	0	4	221
190	2	3	195
216	0	5	221
199	2	2	203
170	0	5	175
185	0	1	186
197	1	3	201
199	0	7	206
220	1	3	224
211	1	3	215
229	0	5	234
248	1	2	251
257	1	4	262
232	2	3	237
226	0	6	232
202	2	1	205
230	0	3	233
222	0	1	223
213	2	1	216
222	0	0	222
189	0	2	191
202	0	5	207
216	2	0	218
178	0	1	179
176	0	1	177
169	0	1	170
145	0	0	145
137	0	3	140
131	0	2	133
127	0	0	127
127	0	1	128
127	0	0	127
159	0	1	160
121	0	0	121
143	1	0	144
91	0	0	91
93	0	0	93
71	0	0	71
60	0	0	60
65	0	1	66
51	0	0	51
33	0	2	35

11:30 PM	26	0	0	26
11:45 PM	31	0	0	31
Total	12248	47	190	12485
Total %	98.1	0.4	1.5	100.0
AM Times	8:00 AM	8:00 AM	11:00 AM	8:00 AM
AM Peaks	804	9	29	828
PM Times	5:00 PM	3:00 PM	12:00 PM	3:30 PM
PM Peaks	887	3	15	984

A & P Consulting Transportation  
10305 Nw 41St St., Suite 115  
Miami, Florida, United States 33178  
(305)592-7283 edsanchez@apcte.com

Count Name: SR 953LeJeune Road between  
Altara Avenue and SR 976Bird Road Thursday  
Site Code: SR 953LeJeune Road between  
Altara Avenue and SR 97  
Start Date: 01/23/2020  
Page No: 7

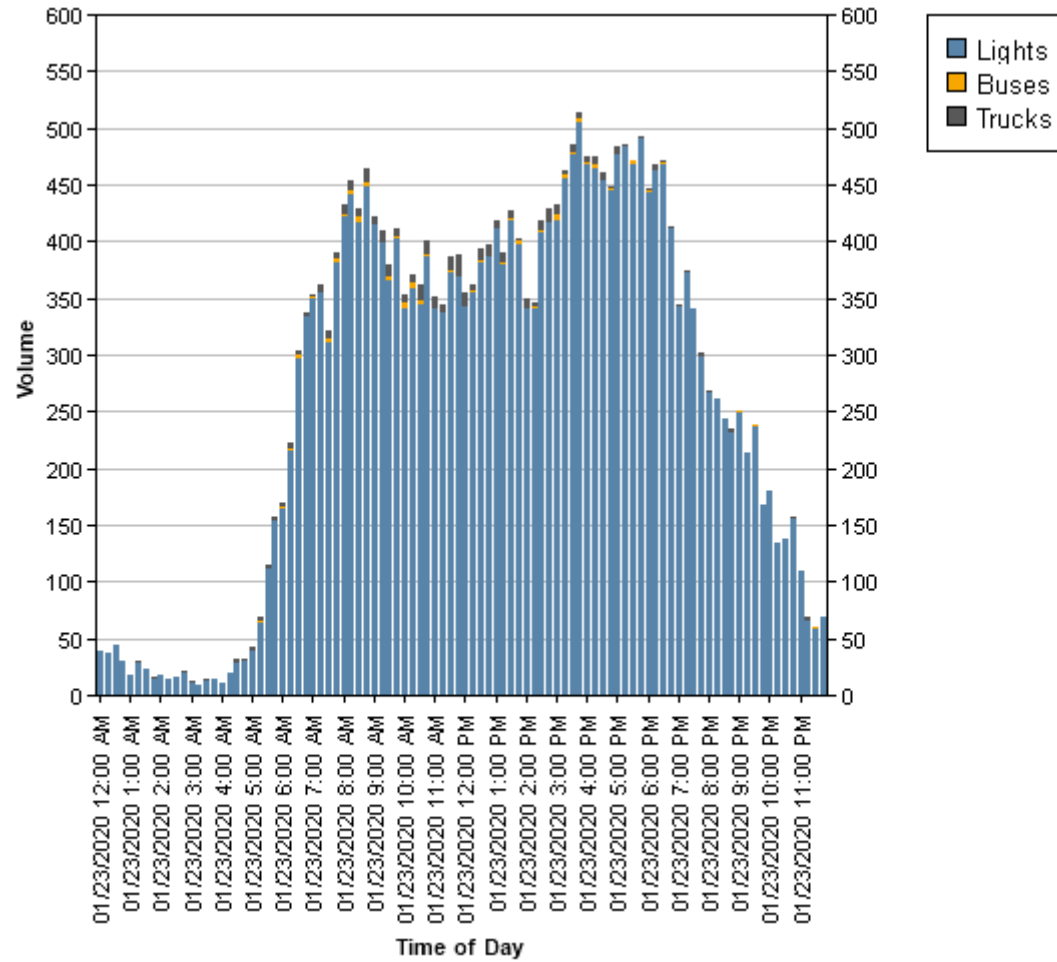

A & P Consulting Transportation  
10305 Nw 41St St., Suite 115  
Miami, Florida, United States 33178  
(305)592-7283 edsanchez@apcte.com

Count Name: SR 953LeJeune Road between  
Altara Avenue and SR 976Bird Road Thursday  
Site Code: SR 953LeJeune Road between  
Altara Avenue and SR 97  
Start Date: 01/23/2020  
Page No: 8

A & P Consulting Transportation  
 10305 Nw 41St St., Suite 115  
 Miami, Florida, United States 33178  
 (305)592-7283 edsanchez@apcte.com

Count Name: Ponce De Leon Boulevard  
 between San Lorenzo Avenue and SR 976Bird  
 Road Tuesday  
 Site Code: Ponce De Leon Boulevard between  
 San Lorenzo Avenue  
 Start Date: 01/21/2020  
 Page No: 1

**Direction (Southbound)**

Start Time	Lights	Buses	Trucks	Total
01/21/2020 12:00 AM	8	0	0	8
12:15 AM	8	0	0	8
12:30 AM	4	0	1	5
12:45 AM	7	0	0	7
1:00 AM	5	0	2	7
1:15 AM	3	0	1	4
1:30 AM	1	0	0	1
1:45 AM	2	0	1	3
2:00 AM	0	0	0	0
2:15 AM	1	0	1	2
2:30 AM	1	0	0	1
2:45 AM	0	0	0	0
3:00 AM	3	0	0	3
3:15 AM	1	0	0	1
3:30 AM	0	0	0	0
3:45 AM	1	0	1	2
4:00 AM	2	0	1	3
4:15 AM	3	0	1	4
4:30 AM	3	0	0	3
4:45 AM	8	0	0	8
5:00 AM	3	0	0	3
5:15 AM	9	0	1	10
5:30 AM	22	0	0	22
5:45 AM	53	0	2	55
6:00 AM	31	0	1	32
6:15 AM	45	0	1	46
6:30 AM	66	0	0	66
6:45 AM	123	2	2	127
7:00 AM	173	2	2	177
7:15 AM	139	3	2	144
7:30 AM	122	2	0	124
7:45 AM	142	2	4	148
8:00 AM	154	1	0	155
8:15 AM	180	3	1	184
8:30 AM	154	1	3	158
8:45 AM	190	2	0	192
9:00 AM	135	2	0	137
9:15 AM	132	1	1	134
9:30 AM	117	2	4	123
9:45 AM	115	1	1	117
10:00 AM	117	2	2	121



10:15 AM  
10:30 AM  
10:45 AM  
11:00 AM  
11:15 AM  
11:30 AM  
11:45 AM  
12:00 PM  
12:15 PM  
12:30 PM  
12:45 PM  
1:00 PM  
1:15 PM  
1:30 PM  
1:45 PM  
2:00 PM  
2:15 PM  
2:30 PM  
2:45 PM  
3:00 PM  
3:15 PM  
3:30 PM  
3:45 PM  
4:00 PM  
4:15 PM  
4:30 PM  
4:45 PM  
5:00 PM  
5:15 PM  
5:30 PM  
5:45 PM  
6:00 PM  
6:15 PM  
6:30 PM  
6:45 PM  
7:00 PM  
7:15 PM  
7:30 PM  
7:45 PM  
8:00 PM  
8:15 PM  
8:30 PM  
8:45 PM  
9:00 PM  
9:15 PM  
9:30 PM  
9:45 PM  
10:00 PM  
10:15 PM  
10:30 PM  
10:45 PM  
11:00 PM

115	2	5	122
111	1	3	115
139	2	2	143
115	2	2	119
119	1	1	121
125	2	8	135
125	1	3	129
125	2	3	130
109	2	1	112
109	2	1	112
137	1	3	141
125	2	2	129
138	1	2	141
123	2	1	126
149	1	3	153
135	1	2	138
149	1	2	152
140	3	2	145
116	1	1	118
112	1	1	114
119	2	1	122
133	2	0	135
157	3	3	163
125	1	4	130
97	1	0	98
127	2	2	131
132	2	3	137
130	1	0	131
133	2	0	135
142	1	1	144
128	2	2	132
111	2	1	114
123	2	3	128
130	2	0	132
99	1	0	100
88	2	0	90
75	2	0	77
58	2	0	60
80	2	0	82
60	1	1	62
42	0	0	42
38	0	0	38
39	0	0	39
40	0	0	40
29	0	0	29
23	0	0	23
29	0	0	29
21	0	0	21
23	0	0	23
13	0	0	13
17	0	0	17
15	0	0	15

11:15 PM	2	0	0	2
Total	7377	92	105	7574
Total %	97.4	1.2	1.4	100.0
AM Times	8:00 AM	7:00 AM	10:45 AM	8:00 AM
AM Peaks	678	9	13	689
PM Times	4:45 PM	3:30 PM	1:45 PM	4:45 PM
PM Peaks	537	7	9	547

A & P Consulting Transportation  
 10305 Nw 41St St., Suite 115  
 Miami, Florida, United States 33178  
 (305)592-7283 edsanchez@apcte.com

Count Name: Ponce De Leon Boulevard  
 between San Lorenzo Avenue and SR 976Bird  
 Road Tuesday  
 Site Code: Ponce De Leon Boulevard between  
 San Lorenzo Avenue  
 Start Date: 01/21/2020  
 Page No: 4

**Direction (Northbound)**

Start Time	Lights	Buses	Trucks	Total
01/21/2020 12:00 AM	10	0	0	10
12:15 AM	5	0	0	5
12:30 AM	1	0	0	1
12:45 AM	4	0	0	4
1:00 AM	5	0	0	5
1:15 AM	4	0	0	4
1:30 AM	1	0	0	1
1:45 AM	3	0	0	3
2:00 AM	1	0	0	1
2:15 AM	1	0	0	1
2:30 AM	0	0	0	0
2:45 AM	0	0	0	0
3:00 AM	2	0	0	2
3:15 AM	1	0	0	1
3:30 AM	0	0	0	0
3:45 AM	0	0	0	0
4:00 AM	1	0	0	1
4:15 AM	0	0	0	0
4:30 AM	0	0	0	0
4:45 AM	6	0	0	6
5:00 AM	4	0	0	4
5:15 AM	6	0	0	6
5:30 AM	10	0	0	10
5:45 AM	8	0	0	8
6:00 AM	14	0	0	14
6:15 AM	18	0	2	20
6:30 AM	31	2	0	33
6:45 AM	58	1	0	59
7:00 AM	85	2	1	88
7:15 AM	90	2	0	92
7:30 AM	80	1	1	82
7:45 AM	82	2	4	88
8:00 AM	106	1	1	108
8:15 AM	111	3	0	114
8:30 AM	123	1	0	124
8:45 AM	130	1	1	132
9:00 AM	115	2	2	119
9:15 AM	108	2	2	112
9:30 AM	114	3	0	117
9:45 AM	107	1	1	109
10:00 AM	101	2	1	104

10:15 AM  
10:30 AM  
10:45 AM  
11:00 AM  
11:15 AM  
11:30 AM  
11:45 AM  
12:00 PM  
12:15 PM  
12:30 PM  
12:45 PM  
1:00 PM  
1:15 PM  
1:30 PM  
1:45 PM  
2:00 PM  
2:15 PM  
2:30 PM  
2:45 PM  
3:00 PM  
3:15 PM  
3:30 PM  
3:45 PM  
4:00 PM  
4:15 PM  
4:30 PM  
4:45 PM  
5:00 PM  
5:15 PM  
5:30 PM  
5:45 PM  
6:00 PM  
6:15 PM  
6:30 PM  
6:45 PM  
7:00 PM  
7:15 PM  
7:30 PM  
7:45 PM  
8:00 PM  
8:15 PM  
8:30 PM  
8:45 PM  
9:00 PM  
9:15 PM  
9:30 PM  
9:45 PM  
10:00 PM  
10:15 PM  
10:30 PM  
10:45 PM  
11:00 PM

85	1	0	86
107	2	1	110
98	1	4	103
102	3	3	108
77	2	0	79
85	1	2	88
116	3	1	120
107	1	0	108
101	2	0	103
91	2	0	93
117	2	0	119
99	1	2	102
90	1	0	91
105	2	0	107
100	1	0	101
82	1	2	85
102	2	1	105
141	2	1	144
113	3	0	116
109	1	1	111
100	0	1	101
107	2	0	109
95	2	0	97
148	2	1	151
111	2	0	113
121	2	1	124
124	1	0	125
136	1	1	138
136	2	1	139
122	1	0	123
106	2	0	108
127	2	0	129
98	1	0	99
97	2	1	100
89	1	0	90
74	2	1	77
66	1	0	67
66	2	0	68
62	2	0	64
63	1	0	64
52	0	0	52
42	0	0	42
50	0	0	50
64	0	0	64
36	0	0	36
26	0	1	27
34	0	0	34
25	0	0	25
24	0	0	24
17	0	0	17
11	0	0	11
25	0	0	25

11:15 PM	2	0	0	2
Total	6029	91	42	6162
Total %	97.8	1.5	0.7	100.0
AM Times	8:00 AM	7:00 AM	10:45 AM	8:00 AM
AM Peaks	470	7	9	478
PM Times	4:45 PM	3:30 PM	1:45 PM	4:45 PM
PM Peaks	518	8	4	525

A & P Consulting Transportation  
10305 Nw 41St St., Suite 115  
Miami, Florida, United States 33178  
(305)592-7283 edsanchez@apcte.com

Count Name: Ponce De Leon Boulevard  
between San Lorenzo Avenue and SR 976Bird  
Road Tuesday  
Site Code: Ponce De Leon Boulevard between  
San Lorenzo Avenue  
Start Date: 01/21/2020  
Page No: 7

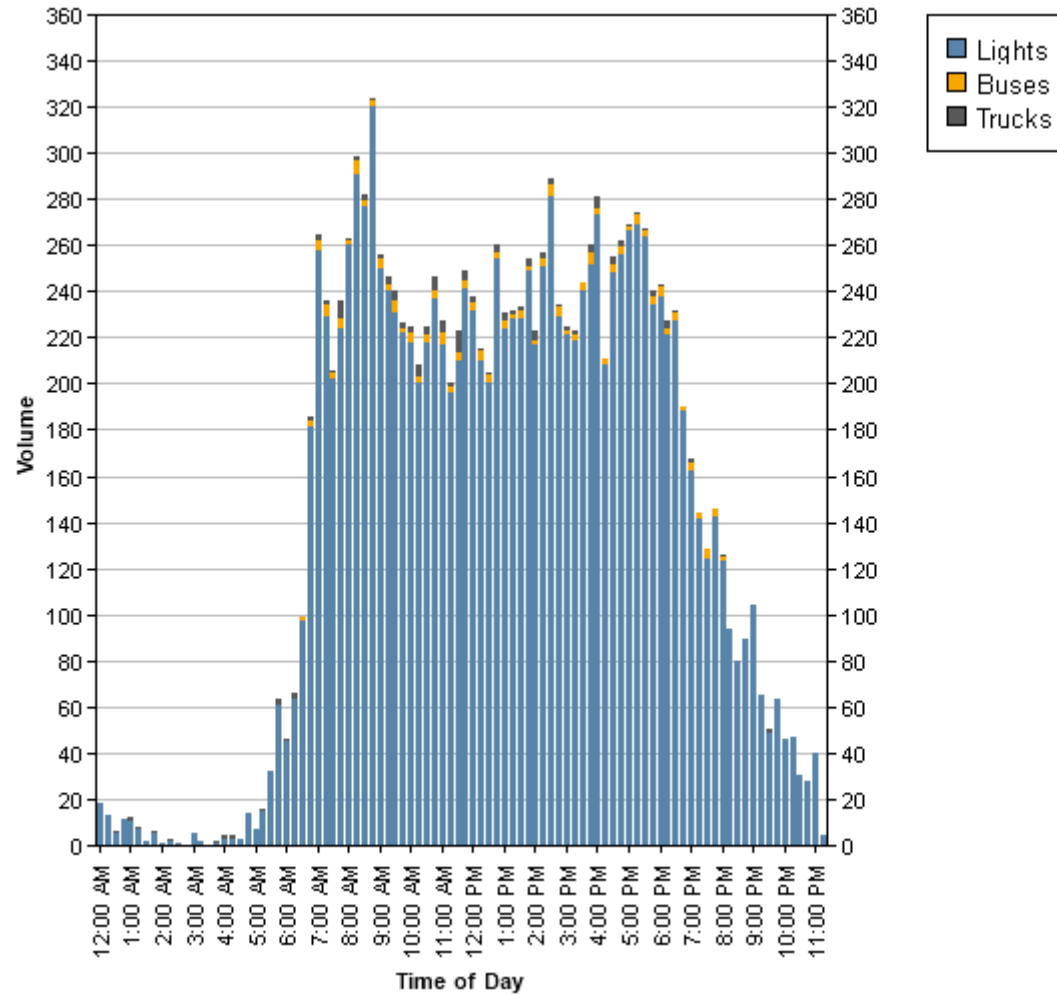

A & P Consulting Transportation  
10305 Nw 41St St., Suite 115  
Miami, Florida, United States 33178  
(305)592-7283 edsanchez@apcte.com

Count Name: Ponce De Leon Boulevard  
between San Lorenzo Avenue and SR 976Bird  
Road Tuesday  
Site Code: Ponce De Leon Boulevard between  
San Lorenzo Avenue  
Start Date: 01/21/2020  
Page No: 8

A & P Consulting Transportation  
 10305 Nw 41St St., Suite 115  
 Miami, Florida, United States 33178  
 (305)592-7283 edsanchez@apcte.com

Count Name: Ponce De Leon Boulevard  
 between San Lorenzo Avenue and SR 976Bird  
 Road FC South Wednesday  
 Site Code: Ponce De Leon Boulevard between  
 San Lorenzo Avenue  
 Start Date: 01/22/2020  
 Page No: 1

**Direction (Southbound)**

Start Time	Lights	Buses	Trucks	Total
01/22/2020 12:00 AM	8	0	0	8
12:15 AM	2	0	0	2
12:30 AM	3	0	0	3
12:45 AM	5	0	0	5
1:00 AM	5	0	0	5
1:15 AM	3	0	0	3
1:30 AM	5	0	0	5
1:45 AM	3	0	0	3
2:00 AM	4	0	0	4
2:15 AM	1	0	1	2
2:30 AM	0	0	0	0
2:45 AM	0	0	0	0
3:00 AM	2	0	0	2
3:15 AM	2	0	0	2
3:30 AM	3	0	0	3
3:45 AM	0	0	0	0
4:00 AM	3	0	1	4
4:15 AM	0	0	0	0
4:30 AM	3	0	0	3
4:45 AM	8	1	1	10
5:00 AM	4	0	1	5
5:15 AM	6	0	0	6
5:30 AM	25	0	0	25
5:45 AM	52	0	0	52
6:00 AM	36	0	1	37
6:15 AM	38	1	0	39
6:30 AM	64	1	2	67
6:45 AM	119	1	3	123
7:00 AM	166	2	1	169
7:15 AM	138	2	2	142
7:30 AM	142	1	1	144
7:45 AM	138	3	2	143
8:00 AM	163	2	1	166
8:15 AM	177	3	3	183
8:30 AM	176	1	4	181
8:45 AM	179	3	0	182
9:00 AM	184	1	4	189
9:15 AM	114	2	2	118
9:30 AM	131	1	2	134
9:45 AM	93	1	1	95
10:00 AM	105	3	0	108



10:15 AM  
10:30 AM  
10:45 AM  
11:00 AM  
11:15 AM  
11:30 AM  
11:45 AM  
12:00 PM  
12:15 PM  
12:30 PM  
12:45 PM  
1:00 PM  
1:15 PM  
1:30 PM  
1:45 PM  
2:00 PM  
2:15 PM  
2:30 PM  
2:45 PM  
3:00 PM  
3:15 PM  
3:30 PM  
3:45 PM  
4:00 PM  
4:15 PM  
4:30 PM  
4:45 PM  
5:00 PM  
5:15 PM  
5:30 PM  
5:45 PM  
6:00 PM  
6:15 PM  
6:30 PM  
6:45 PM  
7:00 PM  
7:15 PM  
7:30 PM  
7:45 PM  
8:00 PM  
8:15 PM  
8:30 PM  
8:45 PM  
9:00 PM  
9:15 PM  
9:30 PM  
9:45 PM  
10:00 PM  
10:15 PM  
10:30 PM  
10:45 PM  
11:00 PM

87	1	3	91
116	1	3	120
125	2	2	129
105	2	0	107
100	2	1	103
104	1	3	108
127	2	2	131
131	1	2	134
112	1	4	117
111	4	0	115
122	1	3	126
139	2	3	144
112	1	4	117
117	2	2	121
123	0	3	126
127	1	3	131
173	2	7	182
165	1	2	168
161	2	0	163
151	0	5	156
129	1	0	130
125	3	1	129
135	1	0	136
128	1	1	130
123	2	1	126
104	1	1	106
119	2	2	123
116	1	0	117
143	2	0	145
137	1	1	139
135	2	2	139
133	1	1	135
138	1	2	141
117	3	1	121
132	2	1	135
103	1	0	104
73	2	0	75
75	2	0	77
51	2	0	53
84	1	0	85
44	1	1	46
36	0	0	36
46	0	0	46
31	0	0	31
39	0	0	39
31	0	1	32
22	0	0	22
28	0	0	28
37	0	0	37
17	0	0	17
29	0	0	29
19	0	0	19

11:15 PM	2	0	0	2
Total	7499	91	101	7691
Total %	97.5	1.2	1.3	100.0
AM Times	8:15 AM	7:45 AM	10:00 AM	8:15 AM
AM Peaks	716	9	8	735
PM Times	2:15 PM	3:30 PM	1:00 PM	2:15 PM
PM Peaks	650	7	12	669

A & P Consulting Transportation  
 10305 Nw 41St St., Suite 115  
 Miami, Florida, United States 33178  
 (305)592-7283 edsanchez@apcte.com

Count Name: Ponce De Leon Boulevard  
 between San Lorenzo Avenue and SR 976Bird  
 Road FC South Wednesday  
 Site Code: Ponce De Leon Boulevard between  
 San Lorenzo Avenue  
 Start Date: 01/22/2020  
 Page No: 4

**Direction (Northbound)**

Start Time	Lights	Buses	Trucks	Total
01/22/2020 12:00 AM	11	0	0	11
12:15 AM	16	0	0	16
12:30 AM	4	0	0	4
12:45 AM	1	0	0	1
1:00 AM	5	0	0	5
1:15 AM	3	0	0	3
1:30 AM	2	0	0	2
1:45 AM	1	0	0	1
2:00 AM	4	0	0	4
2:15 AM	4	0	0	4
2:30 AM	3	0	0	3
2:45 AM	1	0	0	1
3:00 AM	0	0	0	0
3:15 AM	1	0	0	1
3:30 AM	0	0	0	0
3:45 AM	1	0	0	1
4:00 AM	2	0	0	2
4:15 AM	2	0	0	2
4:30 AM	2	0	0	2
4:45 AM	4	0	0	4
5:00 AM	5	0	0	5
5:15 AM	3	0	0	3
5:30 AM	8	0	1	9
5:45 AM	6	0	0	6
6:00 AM	7	0	1	8
6:15 AM	24	0	2	26
6:30 AM	31	2	0	33
6:45 AM	52	1	0	53
7:00 AM	96	2	0	98
7:15 AM	101	2	0	103
7:30 AM	61	1	1	63
7:45 AM	94	1	0	95
8:00 AM	111	2	1	114
8:15 AM	126	2	0	128
8:30 AM	132	3	1	136
8:45 AM	115	1	1	117
9:00 AM	121	1	1	123
9:15 AM	131	2	0	133
9:30 AM	128	1	1	130
9:45 AM	117	1	0	118
10:00 AM	83	2	2	87

10:15 AM  
 10:30 AM  
 10:45 AM  
 11:00 AM  
 11:15 AM  
 11:30 AM  
 11:45 AM  
 12:00 PM  
 12:15 PM  
 12:30 PM  
 12:45 PM  
 1:00 PM  
 1:15 PM  
 1:30 PM  
 1:45 PM  
 2:00 PM  
 2:15 PM  
 2:30 PM  
 2:45 PM  
 3:00 PM  
 3:15 PM  
 3:30 PM  
 3:45 PM  
 4:00 PM  
 4:15 PM  
 4:30 PM  
 4:45 PM  
 5:00 PM  
 5:15 PM  
 5:30 PM  
 5:45 PM  
 6:00 PM  
 6:15 PM  
 6:30 PM  
 6:45 PM  
 7:00 PM  
 7:15 PM  
 7:30 PM  
 7:45 PM  
 8:00 PM  
 8:15 PM  
 8:30 PM  
 8:45 PM  
 9:00 PM  
 9:15 PM  
 9:30 PM  
 9:45 PM  
 10:00 PM  
 10:15 PM  
 10:30 PM  
 10:45 PM  
 11:00 PM

90	1	1	92
92	2	1	95
116	1	4	121
85	2	1	88
88	2	1	91
98	1	0	99
117	2	2	121
85	2	0	87
102	1	0	103
90	2	2	94
94	2	2	98
87	2	2	91
96	1	5	102
107	2	1	110
90	1	5	96
96	0	0	96
115	1	2	118
129	2	1	132
103	2	2	107
117	3	1	121
101	0	2	103
110	3	0	113
122	1	0	123
135	4	2	141
132	1	0	133
115	2	0	117
94	2	1	97
120	1	0	121
123	1	0	124
138	2	0	140
110	2	0	112
119	1	1	121
108	1	1	110
80	2	1	83
70	2	0	72
73	2	0	75
67	1	0	68
70	1	0	71
82	3	0	85
67	1	0	68
52	0	0	52
57	0	0	57
41	0	0	41
60	0	0	60
40	0	0	40
43	0	0	43
39	0	0	39
32	0	0	32
19	0	1	20
19	0	0	19
11	0	0	11
21	0	1	22

11:15 PM	1	0	0	1
Total	6087	89	55	6231
Total %	97.7	1.4	0.9	100.0
AM Times	8:15 AM	7:45 AM	10:00 AM	8:15 AM
AM Peaks	494	8	8	504
PM Times	2:15 PM	3:30 PM	1:00 PM	2:15 PM
PM Peaks	464	9	13	478

A & P Consulting Transportation  
10305 Nw 41St St., Suite 115  
Miami, Florida, United States 33178  
(305)592-7283 edsanchez@apcte.com

Count Name: Ponce De Leon Boulevard  
between San Lorenzo Avenue and SR 976Bird  
Road FC South Wednesday  
Site Code: Ponce De Leon Boulevard between  
San Lorenzo Avenue  
Start Date: 01/22/2020  
Page No: 7

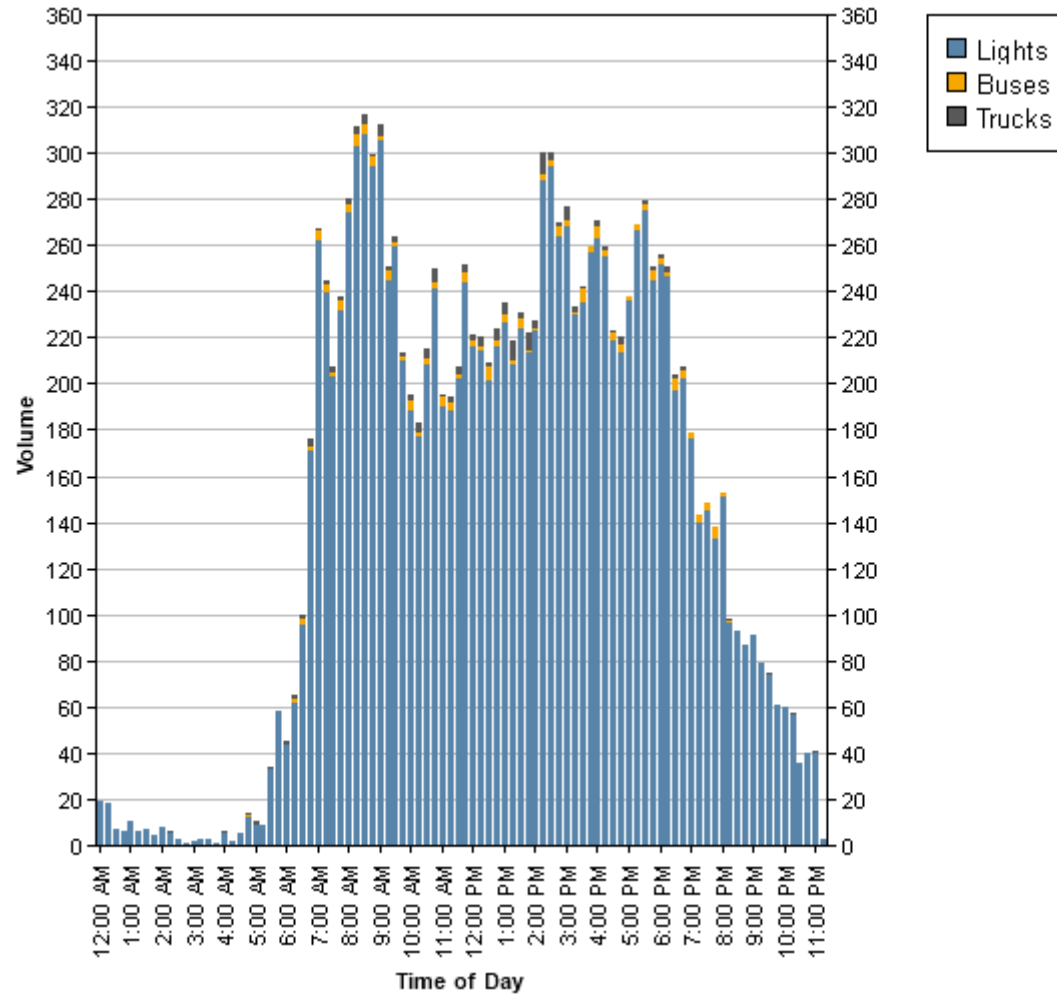

A & P Consulting Transportation  
10305 Nw 41St St., Suite 115  
Miami, Florida, United States 33178  
(305)592-7283 edsanchez@apcte.com

Count Name: Ponce De Leon Boulevard  
between San Lorenzo Avenue and SR 976Bird  
Road FC South Wednesday  
Site Code: Ponce De Leon Boulevard between  
San Lorenzo Avenue  
Start Date: 01/22/2020  
Page No: 8

A & P Consulting Transportation  
 10305 Nw 41St St., Suite 115  
 Miami, Florida, United States 33178  
 (305)592-7283 edsanchez@apcte.com

Count Name: Ponce De Leon Boulevard  
 between San Lorenzo Avenue and SR 976Bird  
 Road FC South Thursday  
 Site Code: Ponce De Leon Boulevard between  
 San Lorenzo Avenue  
 Start Date: 01/23/2020  
 Page No: 1

**Direction (Southbound)**

Start Time	Lights	Buses	Trucks	Total
01/23/2020 12:00 AM	5	0	0	5
12:15 AM	10	0	0	10
12:30 AM	6	0	0	6
12:45 AM	4	0	0	4
1:00 AM	4	0	0	4
1:15 AM	2	0	0	2
1:30 AM	2	0	0	2
1:45 AM	5	0	0	5
2:00 AM	4	0	0	4
2:15 AM	1	0	1	2
2:30 AM	0	0	0	0
2:45 AM	2	0	0	2
3:00 AM	2	0	1	3
3:15 AM	1	0	0	1
3:30 AM	1	0	0	1
3:45 AM	1	0	1	2
4:00 AM	3	0	0	3
4:15 AM	2	0	0	2
4:30 AM	3	0	1	4
4:45 AM	7	1	0	8
5:00 AM	5	0	0	5
5:15 AM	7	0	1	8
5:30 AM	19	1	1	21
5:45 AM	52	0	0	52
6:00 AM	25	0	2	27
6:15 AM	31	1	2	34
6:30 AM	54	0	1	55
6:45 AM	121	2	1	124
7:00 AM	182	2	2	186
7:15 AM	131	3	0	134
7:30 AM	110	1	2	113
7:45 AM	149	2	0	151
8:00 AM	161	1	0	162
8:15 AM	159	2	1	162
8:30 AM	161	1	0	162
8:45 AM	208	2	2	212
9:00 AM	143	2	1	146
9:15 AM	114	2	0	116
9:30 AM	138	1	7	146
9:45 AM	119	2	3	124
10:00 AM	122	1	4	127



10:15 AM  
 10:30 AM  
 10:45 AM  
 11:00 AM  
 11:15 AM  
 11:30 AM  
 11:45 AM  
 12:00 PM  
 12:15 PM  
 12:30 PM  
 12:45 PM  
 1:00 PM  
 1:15 PM  
 1:30 PM  
 1:45 PM  
 2:00 PM  
 2:15 PM  
 2:30 PM  
 2:45 PM  
 3:00 PM  
 3:15 PM  
 3:30 PM  
 3:45 PM  
 4:00 PM  
 4:15 PM  
 4:30 PM  
 4:45 PM  
 5:00 PM  
 5:15 PM  
 5:30 PM  
 5:45 PM  
 6:00 PM  
 6:15 PM  
 6:30 PM  
 6:45 PM  
 7:00 PM  
 7:15 PM  
 7:30 PM  
 7:45 PM  
 8:00 PM  
 8:15 PM  
 8:30 PM  
 8:45 PM  
 9:00 PM  
 9:15 PM  
 9:30 PM  
 9:45 PM  
 10:00 PM  
 10:15 PM  
 10:30 PM  
 10:45 PM  
 11:00 PM

85	2	2	89
96	1	4	101
95	2	3	100
108	1	3	112
105	2	1	108
116	2	4	122
133	2	5	140
109	1	3	113
128	2	2	132
131	2	2	135
127	2	2	131
138	1	2	141
127	2	2	131
144	1	0	145
136	1	3	140
140	1	1	142
148	2	1	151
146	2	2	150
153	0	4	157
118	1	3	122
120	1	1	122
128	3	0	131
141	1	0	142
103	2	1	106
99	2	1	102
118	1	3	122
126	1	1	128
100	3	1	104
120	0	1	121
153	2	2	157
125	1	3	129
111	2	1	114
103	2	0	105
127	1	0	128
104	1	2	107
105	2	2	109
86	3	1	90
59	2	3	64
64	1	1	66
46	1	0	47
49	1	2	52
49	0	2	51
32	0	0	32
37	0	0	37
37	0	2	39
33	0	1	34
31	0	0	31
37	0	0	37
25	0	0	25
21	0	0	21
39	0	0	39
18	0	0	18

11:15 PM	0	0	0	0
Total	7305	90	114	7509
Total %	97.3	1.2	1.5	100.0
AM Times	8:15 AM	7:30 AM	9:30 AM	8:15 AM
AM Peaks	671	6	16	682
PM Times	2:00 PM	3:30 PM	12:00 PM	2:00 PM
PM Peaks	587	8	9	600

A & P Consulting Transportation  
 10305 Nw 41St St., Suite 115  
 Miami, Florida, United States 33178  
 (305)592-7283 edsanchez@apcte.com

Count Name: Ponce De Leon Boulevard  
 between San Lorenzo Avenue and SR 976Bird  
 Road FC South Thursday  
 Site Code: Ponce De Leon Boulevard between  
 San Lorenzo Avenue  
 Start Date: 01/23/2020  
 Page No: 4

**Direction (Northbound)**

Start Time	Lights	Buses	Trucks	Total
01/23/2020 12:00 AM	12	0	0	12
12:15 AM	9	0	0	9
12:30 AM	11	0	0	11
12:45 AM	10	0	0	10
1:00 AM	8	0	0	8
1:15 AM	1	0	0	1
1:30 AM	3	0	0	3
1:45 AM	1	0	1	2
2:00 AM	2	0	1	3
2:15 AM	9	0	0	9
2:30 AM	0	0	0	0
2:45 AM	0	0	0	0
3:00 AM	2	0	0	2
3:15 AM	3	0	0	3
3:30 AM	3	0	0	3
3:45 AM	3	0	0	3
4:00 AM	5	0	0	5
4:15 AM	1	0	0	1
4:30 AM	2	0	0	2
4:45 AM	3	0	0	3
5:00 AM	2	0	0	2
5:15 AM	3	0	0	3
5:30 AM	7	0	0	7
5:45 AM	7	0	0	7
6:00 AM	16	0	1	17
6:15 AM	13	0	2	15
6:30 AM	31	2	0	33
6:45 AM	41	1	1	43
7:00 AM	110	2	0	112
7:15 AM	89	1	0	90
7:30 AM	67	2	4	73
7:45 AM	94	1	0	95
8:00 AM	94	3	1	98
8:15 AM	113	3	0	116
8:30 AM	102	1	0	103
8:45 AM	115	2	0	117
9:00 AM	124	1	1	126
9:15 AM	110	2	2	114
9:30 AM	103	2	1	106
9:45 AM	95	1	4	100
10:00 AM	100	2	0	102

10:15 AM  
10:30 AM  
10:45 AM  
11:00 AM  
11:15 AM  
11:30 AM  
11:45 AM  
12:00 PM  
12:15 PM  
12:30 PM  
12:45 PM  
1:00 PM  
1:15 PM  
1:30 PM  
1:45 PM  
2:00 PM  
2:15 PM  
2:30 PM  
2:45 PM  
3:00 PM  
3:15 PM  
3:30 PM  
3:45 PM  
4:00 PM  
4:15 PM  
4:30 PM  
4:45 PM  
5:00 PM  
5:15 PM  
5:30 PM  
5:45 PM  
6:00 PM  
6:15 PM  
6:30 PM  
6:45 PM  
7:00 PM  
7:15 PM  
7:30 PM  
7:45 PM  
8:00 PM  
8:15 PM  
8:30 PM  
8:45 PM  
9:00 PM  
9:15 PM  
9:30 PM  
9:45 PM  
10:00 PM  
10:15 PM  
10:30 PM  
10:45 PM  
11:00 PM

81	1	2	84
92	2	0	94
89	2	3	94
77	1	0	78
85	2	0	87
89	1	3	93
104	2	1	107
97	2	0	99
88	1	1	90
103	2	2	107
94	2	1	97
87	1	0	88
84	1	2	87
99	1	1	101
89	3	0	92
92	1	0	93
111	1	1	113
137	2	1	140
110	2	0	112
101	2	1	104
93	0	1	94
123	3	0	126
132	2	2	136
132	3	2	137
112	2	2	116
129	1	0	130
113	2	1	116
139	1	0	140
116	2	0	118
124	1	0	125
110	2	1	113
118	1	0	119
99	2	1	102
112	2	2	116
84	1	0	85
105	1	0	106
60	2	0	62
68	2	0	70
54	2	1	57
59	1	0	60
48	0	0	48
37	0	1	38
26	0	0	26
48	0	0	48
23	0	0	23
38	0	0	38
24	0	0	24
14	0	1	15
29	0	0	29
24	0	0	24
14	0	1	15
11	0	0	11

11:15 PM	2	0	0	2
Total	5853	91	54	5998
Total %	97.6	1.5	0.9	100.0
AM Times	8:15 AM	7:30 AM	9:30 AM	8:15 AM
AM Peaks	454	9	7	462
PM Times	2:00 PM	3:30 PM	12:00 PM	2:00 PM
PM Peaks	450	10	4	458

A & P Consulting Transportation  
10305 Nw 41St St., Suite 115  
Miami, Florida, United States 33178  
(305)592-7283 edsanchez@apcte.com

Count Name: Ponce De Leon Boulevard  
between San Lorenzo Avenue and SR 976Bird  
Road FC South Thursday  
Site Code: Ponce De Leon Boulevard between  
San Lorenzo Avenue  
Start Date: 01/23/2020  
Page No: 7

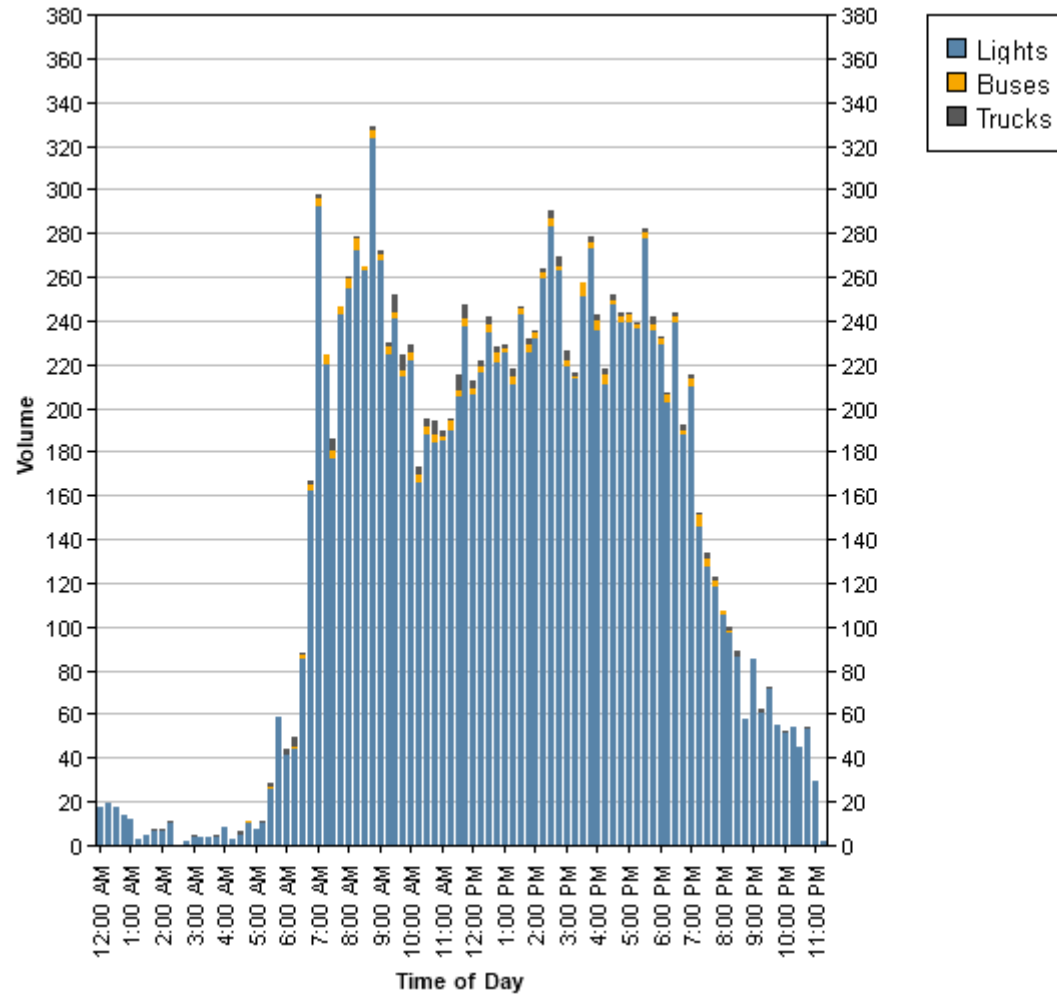

A & P Consulting Transportation  
10305 Nw 41St St., Suite 115  
Miami, Florida, United States 33178  
(305)592-7283 edsanchez@apcte.com

Count Name: Ponce De Leon Boulevard  
between San Lorenzo Avenue and SR 976Bird  
Road FC South Thursday  
Site Code: Ponce De Leon Boulevard between  
San Lorenzo Avenue  
Start Date: 01/23/2020  
Page No: 8

A & P Consulting Transportation  
 10305 Nw 41St St., Suite 115  
 Miami, Florida, United States 33178  
 (305)592-7283 edsanchez@apcte.com

Count Name: Aurora Street between Altara  
 Avenue and SR 976Bird Road FC North  
 Wednesday  
 Site Code: Aurora Street between Altara Avenue  
 and SR 976Bird  
 Start Date: 01/22/2020  
 Page No: 1

**Direction (Southbound)**

Start Time	Lights	Buses	Trucks	Total
01/22/2020 12:00 AM	0	0	0	0
12:15 AM	0	0	0	0
12:30 AM	0	0	0	0
12:45 AM	0	0	0	0
1:00 AM	0	0	0	0
1:15 AM	1	0	0	1
1:30 AM	0	0	0	0
1:45 AM	1	0	0	1
2:00 AM	1	0	0	1
2:15 AM	0	0	0	0
2:30 AM	0	0	0	0
2:45 AM	1	0	0	1
3:00 AM	0	0	0	0
3:15 AM	0	0	0	0
3:30 AM	0	0	1	1
3:45 AM	0	0	0	0
4:00 AM	0	0	0	0
4:15 AM	0	0	0	0
4:30 AM	0	0	0	0
4:45 AM	0	0	0	0
5:00 AM	0	0	0	0
5:15 AM	0	0	0	0
5:30 AM	0	0	0	0
5:45 AM	1	0	0	1
6:00 AM	2	0	0	2
6:15 AM	0	0	0	0
6:30 AM	3	0	0	3
6:45 AM	3	1	1	5
7:00 AM	5	0	0	5
7:15 AM	5	0	0	5
7:30 AM	3	0	1	4
7:45 AM	9	0	0	9
8:00 AM	10	0	0	10
8:15 AM	4	0	1	5
8:30 AM	3	0	0	3
8:45 AM	5	0	0	5
9:00 AM	12	0	0	12
9:15 AM	13	0	1	14
9:30 AM	19	0	0	19
9:45 AM	7	0	0	7
10:00 AM	2	0	1	3



10:15 AM  
10:30 AM  
10:45 AM  
11:00 AM  
11:15 AM  
11:30 AM  
11:45 AM  
12:00 PM  
12:15 PM  
12:30 PM  
12:45 PM  
1:00 PM  
1:15 PM  
1:30 PM  
1:45 PM  
2:00 PM  
2:15 PM  
2:30 PM  
2:45 PM  
3:00 PM  
3:15 PM  
3:30 PM  
3:45 PM  
4:00 PM  
4:15 PM  
4:30 PM  
4:45 PM  
5:00 PM  
5:15 PM  
5:30 PM  
5:45 PM  
6:00 PM  
6:15 PM  
6:30 PM  
6:45 PM  
7:00 PM  
7:15 PM  
7:30 PM  
7:45 PM  
8:00 PM  
8:15 PM  
8:30 PM  
8:45 PM  
9:00 PM  
9:15 PM  
9:30 PM  
9:45 PM  
10:00 PM  
10:15 PM  
10:30 PM  
10:45 PM  
11:00 PM

10	0	0	10
15	0	1	16
20	0	0	20
10	0	0	10
12	0	1	13
18	0	0	18
19	0	0	19
11	0	1	12
16	0	0	16
18	0	0	18
7	0	0	7
16	0	0	16
27	0	0	27
14	0	0	14
19	0	1	20
17	0	0	17
14	0	1	15
21	0	0	21
20	0	2	22
19	0	1	20
15	0	1	16
10	0	0	10
18	0	0	18
29	0	0	29
16	0	0	16
25	0	1	26
20	0	0	20
43	0	0	43
31	0	0	31
35	0	0	35
32	0	0	32
32	0	0	32
31	0	0	31
17	0	0	17
10	0	0	10
14	0	0	14
16	0	0	16
9	0	0	9
10	0	0	10
19	0	0	19
8	0	1	9
5	0	0	5
4	0	0	4
6	0	0	6
0	0	0	0
2	0	0	2
2	0	1	3
1	0	0	1
4	0	0	4
2	0	0	2
2	0	0	2
0	0	0	0

11:15 PM	1	0	0	1
11:30 PM	0	0	0	0
11:45 PM	1	0	0	1
Total	903	1	18	922
Total %	97.9	0.1	2.0	100.0
AM Times	8:45 AM	6:00 AM	9:45 AM	8:45 AM
AM Peaks	49	1	2	50
PM Times	5:00 PM	12:00 PM	2:15 PM	5:00 PM
PM Peaks	141	0	4	141

A & P Consulting Transportation  
 10305 Nw 41St St., Suite 115  
 Miami, Florida, United States 33178  
 (305)592-7283 edsanchez@apcte.com

Count Name: Aurora Street between Altara  
 Avenue and SR 976Bird Road FC North  
 Wednesday  
 Site Code: Aurora Street between Altara Avenue  
 and SR 976Bird  
 Start Date: 01/22/2020  
 Page No: 4

**Direction (Northbound)**

Start Time	Lights	Buses	Trucks	Total
01/22/2020 12:00 AM	2	0	0	2
12:15 AM	0	0	0	0
12:30 AM	1	0	0	1
12:45 AM	2	0	0	2
1:00 AM	0	0	0	0
1:15 AM	1	0	0	1
1:30 AM	0	0	0	0
1:45 AM	1	0	0	1
2:00 AM	0	0	0	0
2:15 AM	0	0	0	0
2:30 AM	0	0	0	0
2:45 AM	1	0	0	1
3:00 AM	0	0	0	0
3:15 AM	0	0	0	0
3:30 AM	1	0	0	1
3:45 AM	0	0	0	0
4:00 AM	0	0	1	1
4:15 AM	0	0	0	0
4:30 AM	1	0	0	1
4:45 AM	2	0	0	2
5:00 AM	0	0	0	0
5:15 AM	2	0	0	2
5:30 AM	1	0	0	1
5:45 AM	3	0	0	3
6:00 AM	1	0	0	1
6:15 AM	2	0	0	2
6:30 AM	4	0	2	6
6:45 AM	10	0	0	10
7:00 AM	18	0	0	18
7:15 AM	20	0	0	20
7:30 AM	17	0	0	17
7:45 AM	12	0	0	12
8:00 AM	27	0	1	28
8:15 AM	31	0	0	31
8:30 AM	31	0	0	31
8:45 AM	41	0	0	41
9:00 AM	62	0	1	63
9:15 AM	33	0	1	34
9:30 AM	30	0	1	31
9:45 AM	19	0	1	20
10:00 AM	32	0	2	34

10:15 AM  
 10:30 AM  
 10:45 AM  
 11:00 AM  
 11:15 AM  
 11:30 AM  
 11:45 AM  
 12:00 PM  
 12:15 PM  
 12:30 PM  
 12:45 PM  
 1:00 PM  
 1:15 PM  
 1:30 PM  
 1:45 PM  
 2:00 PM  
 2:15 PM  
 2:30 PM  
 2:45 PM  
 3:00 PM  
 3:15 PM  
 3:30 PM  
 3:45 PM  
 4:00 PM  
 4:15 PM  
 4:30 PM  
 4:45 PM  
 5:00 PM  
 5:15 PM  
 5:30 PM  
 5:45 PM  
 6:00 PM  
 6:15 PM  
 6:30 PM  
 6:45 PM  
 7:00 PM  
 7:15 PM  
 7:30 PM  
 7:45 PM  
 8:00 PM  
 8:15 PM  
 8:30 PM  
 8:45 PM  
 9:00 PM  
 9:15 PM  
 9:30 PM  
 9:45 PM  
 10:00 PM  
 10:15 PM  
 10:30 PM  
 10:45 PM  
 11:00 PM

20	0	2	22
26	0	2	28
28	0	1	29
24	0	0	24
26	0	0	26
28	0	1	29
24	0	0	24
20	0	2	22
19	0	1	20
9	0	0	9
12	0	1	13
26	0	2	28
12	0	1	13
24	0	0	24
23	0	3	26
22	0	0	22
27	0	2	29
24	0	0	24
25	0	0	25
24	0	2	26
23	0	1	24
22	0	1	23
23	0	0	23
15	0	2	17
15	0	1	16
16	0	1	17
16	0	0	16
20	0	0	20
15	0	0	15
17	0	0	17
19	0	1	20
14	0	2	16
17	0	2	19
11	0	0	11
12	0	0	12
7	0	0	7
11	0	0	11
11	0	0	11
12	0	0	12
8	0	0	8
1	0	1	2
5	0	0	5
8	0	0	8
2	0	0	2
4	0	0	4
5	0	1	6
4	0	1	5
1	0	0	1
3	0	0	3
1	0	0	1
6	0	0	6
3	0	0	3

11:15 PM	2	0	0	2
11:30 PM	1	0	0	1
11:45 PM	1	0	0	1
Total	1202	0	44	1246
Total %	96.5	0.0	3.5	100.0
AM Times	8:45 AM	6:00 AM	9:45 AM	8:45 AM
AM Peaks	166	0	7	169
PM Times	5:00 PM	12:00 PM	2:15 PM	5:00 PM
PM Peaks	71	0	4	72

A & P Consulting Transportation  
10305 Nw 41St St., Suite 115  
Miami, Florida, United States 33178  
(305)592-7283 edsanchez@apcte.com

Count Name: Aurora Street between Altara  
Avenue and SR 976Bird Road FC North  
Wednesday  
Site Code: Aurora Street between Altara Avenue  
and SR 976Bird  
Start Date: 01/22/2020  
Page No: 7

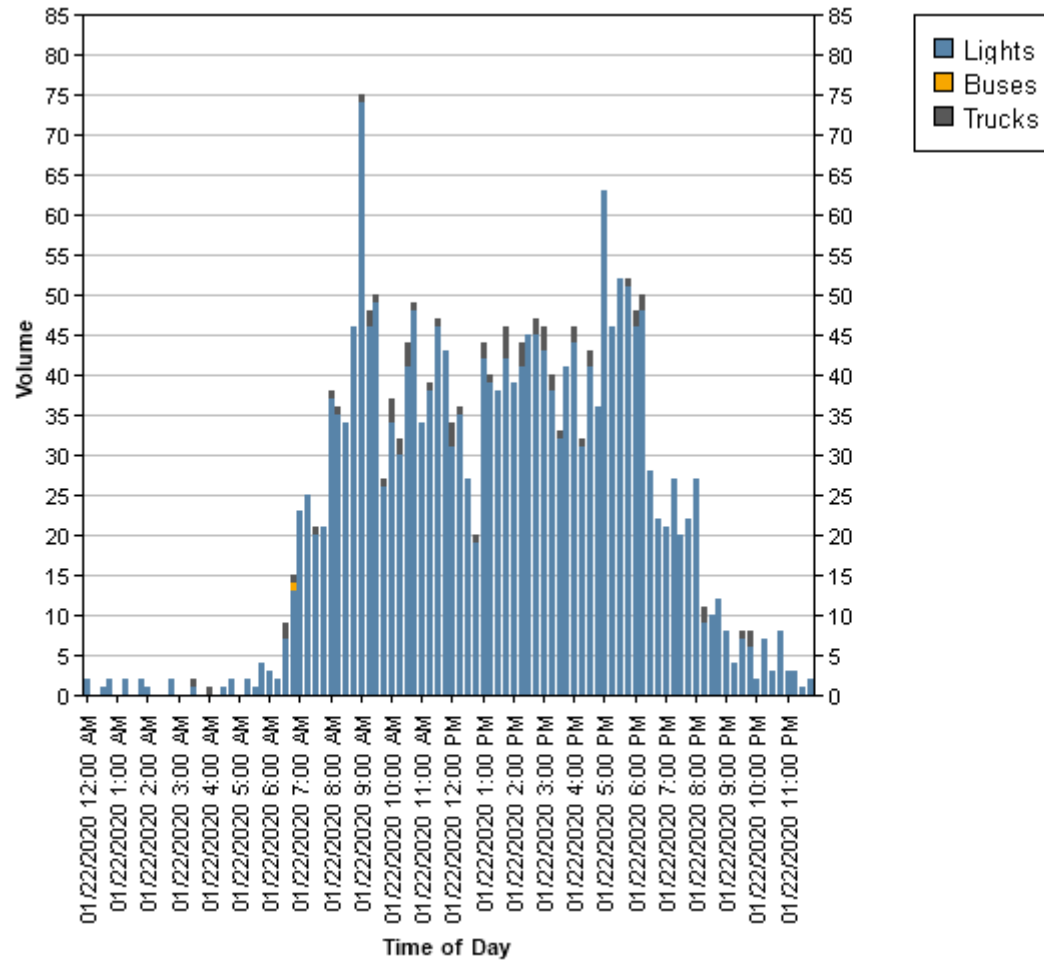

A & P Consulting Transportation  
10305 Nw 41St St., Suite 115  
Miami, Florida, United States 33178  
(305)592-7283 edsanchez@apcte.com

Count Name: Aurora Street between Altara  
Avenue and SR 976Bird Road FC North  
Wednesday  
Site Code: Aurora Street between Altara Avenue  
and SR 976Bird  
Start Date: 01/22/2020  
Page No: 8

A & P Consulting Transportation  
 10305 Nw 41St St., Suite 115  
 Miami, Florida, United States 33178  
 (305)592-7283 edsanchez@apcte.com

Count Name: Aurora Street between Altara  
 Avenue and SR 976Bird Road FC North  
 Tuesday  
 Site Code: Aurora Street between Altara Avenue  
 and SR 976Bird  
 Start Date: 01/21/2020  
 Page No: 1

**Direction (Southbound)**

Start Time	Lights	Buses	Trucks	Total
01/21/2020 12:00 AM	3	0	0	3
12:15 AM	0	0	0	0
12:30 AM	1	0	0	1
12:45 AM	1	0	0	1
1:00 AM	2	0	0	2
1:15 AM	0	0	0	0
1:30 AM	0	0	0	0
1:45 AM	0	0	0	0
2:00 AM	1	0	0	1
2:15 AM	0	0	1	1
2:30 AM	0	0	0	0
2:45 AM	0	0	0	0
3:00 AM	0	0	0	0
3:15 AM	0	0	0	0
3:30 AM	0	0	0	0
3:45 AM	0	0	0	0
4:00 AM	0	0	1	1
4:15 AM	0	0	0	0
4:30 AM	0	0	0	0
4:45 AM	0	0	0	0
5:00 AM	0	0	0	0
5:15 AM	0	0	0	0
5:30 AM	0	0	0	0
5:45 AM	1	0	2	3
6:00 AM	2	0	0	2
6:15 AM	1	0	1	2
6:30 AM	2	0	0	2
6:45 AM	0	1	0	1
7:00 AM	2	0	0	2
7:15 AM	4	0	1	5
7:30 AM	5	0	0	5
7:45 AM	7	0	0	7
8:00 AM	4	0	0	4
8:15 AM	6	0	1	7
8:30 AM	10	0	0	10
8:45 AM	10	0	0	10
9:00 AM	8	0	1	9
9:15 AM	9	0	0	9
9:30 AM	11	0	0	11
9:45 AM	12	0	0	12
10:00 AM	18	0	1	19



10:15 AM  
10:30 AM  
10:45 AM  
11:00 AM  
11:15 AM  
11:30 AM  
11:45 AM  
12:00 PM  
12:15 PM  
12:30 PM  
12:45 PM  
1:00 PM  
1:15 PM  
1:30 PM  
1:45 PM  
2:00 PM  
2:15 PM  
2:30 PM  
2:45 PM  
3:00 PM  
3:15 PM  
3:30 PM  
3:45 PM  
4:00 PM  
4:15 PM  
4:30 PM  
4:45 PM  
5:00 PM  
5:15 PM  
5:30 PM  
5:45 PM  
6:00 PM  
6:15 PM  
6:30 PM  
6:45 PM  
7:00 PM  
7:15 PM  
7:30 PM  
7:45 PM  
8:00 PM  
8:15 PM  
8:30 PM  
8:45 PM  
9:00 PM  
9:15 PM  
9:30 PM  
9:45 PM  
10:00 PM  
10:15 PM  
10:30 PM  
10:45 PM  
11:00 PM

14	0	1	15
9	0	0	9
13	0	0	13
16	0	2	18
10	0	0	10
13	0	0	13
20	0	0	20
16	0	0	16
16	0	0	16
18	0	0	18
18	0	0	18
24	0	0	24
23	0	1	24
23	0	0	23
17	0	1	18
11	0	0	11
16	0	1	17
16	0	0	16
22	0	0	22
9	0	0	9
14	0	0	14
26	0	0	26
12	0	0	12
30	0	0	30
17	0	1	18
16	0	0	16
18	0	0	18
53	0	0	53
26	0	0	26
34	0	1	35
30	0	0	30
24	0	0	24
18	0	0	18
26	0	0	26
20	0	0	20
10	0	1	11
12	0	0	12
11	0	0	11
7	0	0	7
12	0	2	14
11	0	0	11
8	0	0	8
4	0	0	4
3	0	0	3
2	0	0	2
3	0	0	3
0	0	0	0
3	0	0	3
7	0	0	7
1	0	0	1
1	0	0	1
0	0	0	0

11:15 PM	2	0	0	2
11:30 PM	1	0	0	1
11:45 PM	1	0	0	1
Total	907	1	20	928
Total %	97.7	0.1	2.2	100.0
AM Times	8:45 AM	6:00 AM	9:45 AM	9:15 AM
AM Peaks	38	1	2	51
PM Times	12:45 PM	12:00 PM	1:45 PM	12:45 PM
PM Peaks	88	0	2	89

A & P Consulting Transportation  
 10305 Nw 41St St., Suite 115  
 Miami, Florida, United States 33178  
 (305)592-7283 edsanchez@apcte.com

Count Name: Aurora Street between Altara  
 Avenue and SR 976Bird Road FC North  
 Tuesday  
 Site Code: Aurora Street between Altara Avenue  
 and SR 976Bird  
 Start Date: 01/21/2020  
 Page No: 4

**Direction (Northbound)**

Start Time	Lights	Buses	Trucks	Total
01/21/2020 12:00 AM	0	0	0	0
12:15 AM	3	0	0	3
12:30 AM	1	0	1	2
12:45 AM	1	0	0	1
1:00 AM	0	0	2	2
1:15 AM	0	0	1	1
1:30 AM	0	0	0	0
1:45 AM	1	0	0	1
2:00 AM	0	0	0	0
2:15 AM	0	0	1	1
2:30 AM	0	0	0	0
2:45 AM	0	0	0	0
3:00 AM	1	0	0	1
3:15 AM	0	0	0	0
3:30 AM	0	0	0	0
3:45 AM	0	0	1	1
4:00 AM	0	0	0	0
4:15 AM	0	0	0	0
4:30 AM	0	0	0	0
4:45 AM	0	0	0	0
5:00 AM	0	0	0	0
5:15 AM	1	0	0	1
5:30 AM	1	0	0	1
5:45 AM	3	0	1	4
6:00 AM	1	0	0	1
6:15 AM	3	0	1	4
6:30 AM	3	0	0	3
6:45 AM	9	0	0	9
7:00 AM	18	0	1	19
7:15 AM	20	0	0	20
7:30 AM	13	0	0	13
7:45 AM	25	0	0	25
8:00 AM	14	0	0	14
8:15 AM	27	0	0	27
8:30 AM	27	0	0	27
8:45 AM	45	0	0	45
9:00 AM	33	0	0	33
9:15 AM	48	0	2	50
9:30 AM	37	0	0	37
9:45 AM	29	0	2	31
10:00 AM	37	0	2	39

10:15 AM  
10:30 AM  
10:45 AM  
11:00 AM  
11:15 AM  
11:30 AM  
11:45 AM  
12:00 PM  
12:15 PM  
12:30 PM  
12:45 PM  
1:00 PM  
1:15 PM  
1:30 PM  
1:45 PM  
2:00 PM  
2:15 PM  
2:30 PM  
2:45 PM  
3:00 PM  
3:15 PM  
3:30 PM  
3:45 PM  
4:00 PM  
4:15 PM  
4:30 PM  
4:45 PM  
5:00 PM  
5:15 PM  
5:30 PM  
5:45 PM  
6:00 PM  
6:15 PM  
6:30 PM  
6:45 PM  
7:00 PM  
7:15 PM  
7:30 PM  
7:45 PM  
8:00 PM  
8:15 PM  
8:30 PM  
8:45 PM  
9:00 PM  
9:15 PM  
9:30 PM  
9:45 PM  
10:00 PM  
10:15 PM  
10:30 PM  
10:45 PM  
11:00 PM

33	0	4	37
26	0	1	27
32	0	0	32
31	0	0	31
23	0	0	23
23	0	2	25
22	0	0	22
27	0	1	28
20	0	0	20
21	0	0	21
33	0	1	34
31	0	0	31
25	0	0	25
30	0	0	30
25	0	3	28
19	0	4	23
27	0	2	29
15	0	2	17
23	0	0	23
16	0	0	16
21	0	2	23
15	0	2	17
19	0	2	21
24	0	2	26
14	0	1	15
19	0	1	20
16	0	0	16
4	0	0	4
13	0	0	13
12	0	0	12
10	0	2	12
14	0	0	14
16	0	1	17
11	0	1	12
13	0	0	13
8	0	1	9
9	0	0	9
5	0	0	5
9	0	0	9
6	0	1	7
4	0	0	4
8	0	0	8
3	0	0	3
4	0	0	4
3	0	0	3
3	0	0	3
7	0	0	7
1	0	0	1
2	0	0	2
3	0	0	3
2	0	0	2
0	0	0	0

11:15 PM	0	0	0	0
11:30 PM	1	0	0	1
11:45 PM	1	0	0	1
Total	1203	0	51	1254
Total %	95.9	0.0	4.1	100.0
AM Times	8:45 AM	6:00 AM	9:45 AM	9:15 AM
AM Peaks	163	0	9	157
PM Times	12:45 PM	12:00 PM	1:45 PM	12:45 PM
PM Peaks	119	0	11	120

A & P Consulting Transportation  
10305 Nw 41St St., Suite 115  
Miami, Florida, United States 33178  
(305)592-7283 edsanchez@apcte.com

Count Name: Aurora Street between Altara  
Avenue and SR 976Bird Road FC North  
Tuesday  
Site Code: Aurora Street between Altara Avenue  
and SR 976Bird  
Start Date: 01/21/2020  
Page No: 7

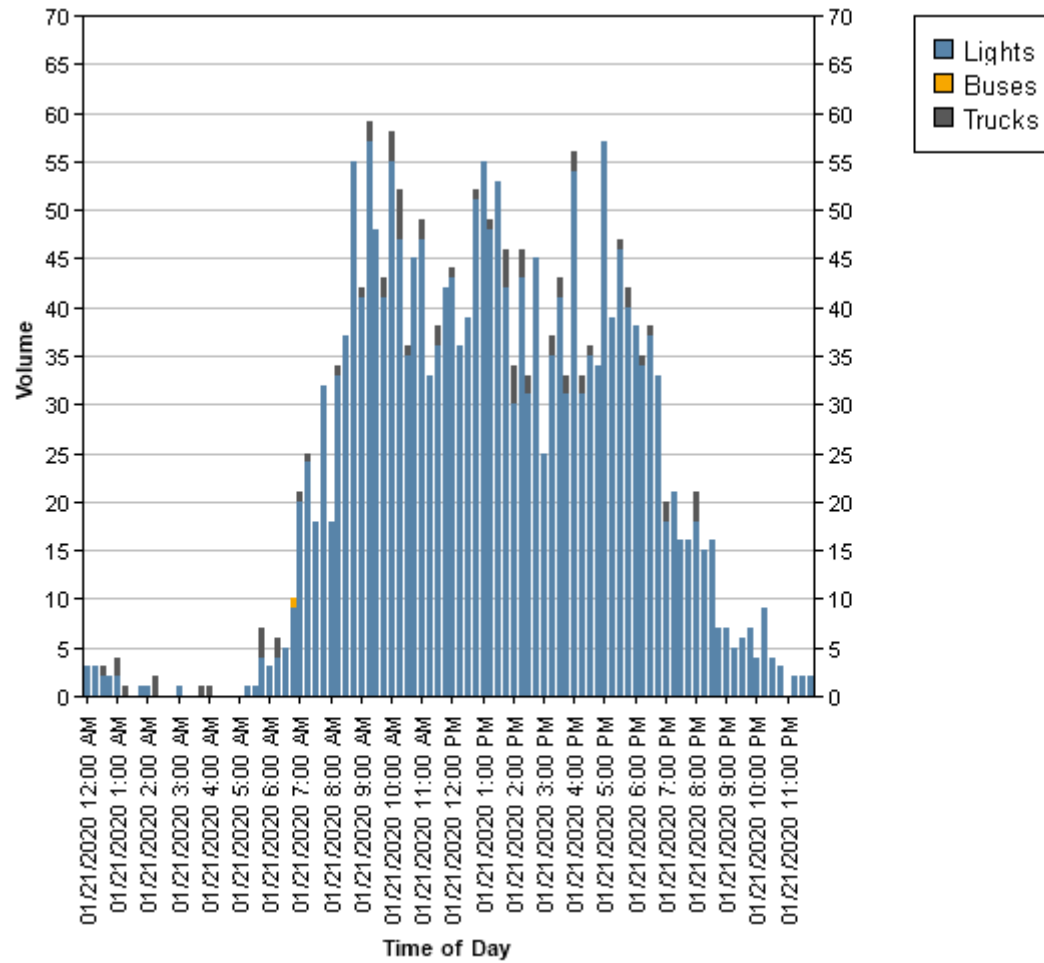

A & P Consulting Transportation  
10305 Nw 41St St., Suite 115  
Miami, Florida, United States 33178  
(305)592-7283 edsanchez@apcte.com

Count Name: Aurora Street between Altara  
Avenue and SR 976Bird Road FC North  
Tuesday  
Site Code: Aurora Street between Altara Avenue  
and SR 976Bird  
Start Date: 01/21/2020  
Page No: 8

A & P Consulting Transportation  
 10305 Nw 41St St., Suite 115  
 Miami, Florida, United States 33178  
 (305)592-7283 edsanchez@apcte.com

Count Name: Aurora Street between Altara  
 Avenue and SR 976Bird Road FC North  
 Thursday  
 Site Code: Aurora Street between Altara Avenue  
 and SR 976Bird  
 Start Date: 01/23/2020  
 Page No: 1

**Direction (Southbound)**

Start Time	Lights	Buses	Trucks	Total
01/23/2020 12:00 AM	1	0	0	1
12:15 AM	0	0	0	0
12:30 AM	0	0	0	0
12:45 AM	0	0	0	0
1:00 AM	0	0	0	0
1:15 AM	0	0	0	0
1:30 AM	1	0	0	1
1:45 AM	0	0	1	1
2:00 AM	3	0	0	3
2:15 AM	0	0	0	0
2:30 AM	0	0	0	0
2:45 AM	0	0	0	0
3:00 AM	0	0	0	0
3:15 AM	0	0	0	0
3:30 AM	0	0	0	0
3:45 AM	1	0	0	1
4:00 AM	0	0	0	0
4:15 AM	0	0	0	0
4:30 AM	0	0	1	1
4:45 AM	0	0	0	0
5:00 AM	0	0	0	0
5:15 AM	0	0	0	0
5:30 AM	1	0	0	1
5:45 AM	0	0	0	0
6:00 AM	4	0	0	4
6:15 AM	1	0	0	1
6:30 AM	2	0	1	3
6:45 AM	1	0	0	1
7:00 AM	2	0	0	2
7:15 AM	4	0	0	4
7:30 AM	6	0	0	6
7:45 AM	8	0	0	8
8:00 AM	8	0	1	9
8:15 AM	14	0	0	14
8:30 AM	8	0	0	8
8:45 AM	7	0	1	8
9:00 AM	13	0	1	14
9:15 AM	7	0	0	7
9:30 AM	17	0	1	18
9:45 AM	12	0	1	13
10:00 AM	13	0	1	14



10:15 AM  
10:30 AM  
10:45 AM  
11:00 AM  
11:15 AM  
11:30 AM  
11:45 AM  
12:00 PM  
12:15 PM  
12:30 PM  
12:45 PM  
1:00 PM  
1:15 PM  
1:30 PM  
1:45 PM  
2:00 PM  
2:15 PM  
2:30 PM  
2:45 PM  
3:00 PM  
3:15 PM  
3:30 PM  
3:45 PM  
4:00 PM  
4:15 PM  
4:30 PM  
4:45 PM  
5:00 PM  
5:15 PM  
5:30 PM  
5:45 PM  
6:00 PM  
6:15 PM  
6:30 PM  
6:45 PM  
7:00 PM  
7:15 PM  
7:30 PM  
7:45 PM  
8:00 PM  
8:15 PM  
8:30 PM  
8:45 PM  
9:00 PM  
9:15 PM  
9:30 PM  
9:45 PM  
10:00 PM  
10:15 PM  
10:30 PM  
10:45 PM  
11:00 PM

15	0	0	15
7	0	2	9
11	0	0	11
15	0	0	15
13	0	1	14
18	0	0	18
11	0	1	12
16	0	0	16
14	0	0	14
28	0	1	29
20	0	0	20
24	0	0	24
25	0	1	26
12	0	1	13
17	0	0	17
16	0	0	16
18	0	1	19
22	0	0	22
19	0	1	20
9	0	1	10
14	0	1	15
24	0	1	25
7	0	0	7
29	0	0	29
26	0	1	27
15	0	1	16
22	0	0	22
49	0	1	50
31	0	0	31
23	0	1	24
28	0	0	28
22	0	0	22
29	0	1	30
27	0	0	27
13	0	0	13
14	0	0	14
6	0	0	6
11	0	0	11
12	0	0	12
6	0	0	6
4	0	0	4
7	0	0	7
3	0	0	3
5	0	0	5
0	0	0	0
5	0	0	5
4	0	0	4
5	0	0	5
2	0	0	2
1	0	0	1
1	0	0	1
1	0	0	1

11:15 PM	1	0	0	1
11:30 PM	0	0	0	0
11:45 PM	1	0	0	1
Total	912	0	26	938
Total %	97.2	0.0	2.8	100.0
AM Times	9:00 AM	12:00 AM	9:45 AM	9:00 AM
AM Peaks	49	0	4	52
PM Times	12:30 PM	12:00 PM	2:15 PM	12:30 PM
PM Peaks	97	0	3	99

A & P Consulting Transportation  
 10305 Nw 41St St., Suite 115  
 Miami, Florida, United States 33178  
 (305)592-7283 edsanchez@apcte.com

Count Name: Aurora Street between Altara  
 Avenue and SR 976Bird Road FC North  
 Thursday  
 Site Code: Aurora Street between Altara Avenue  
 and SR 976Bird  
 Start Date: 01/23/2020  
 Page No: 4

**Direction (Northbound)**

Start Time	Lights	Buses	Trucks	Total
01/23/2020 12:00 AM	0	0	0	0
12:15 AM	3	0	0	3
12:30 AM	3	0	0	3
12:45 AM	4	0	0	4
1:00 AM	0	0	0	0
1:15 AM	1	0	0	1
1:30 AM	2	0	0	2
1:45 AM	1	0	0	1
2:00 AM	2	0	0	2
2:15 AM	0	0	0	0
2:30 AM	0	0	0	0
2:45 AM	0	0	0	0
3:00 AM	1	0	0	1
3:15 AM	0	0	0	0
3:30 AM	0	0	0	0
3:45 AM	0	0	0	0
4:00 AM	0	0	1	1
4:15 AM	0	0	0	0
4:30 AM	0	0	0	0
4:45 AM	0	0	0	0
5:00 AM	0	0	0	0
5:15 AM	2	0	0	2
5:30 AM	1	0	0	1
5:45 AM	2	0	0	2
6:00 AM	0	0	1	1
6:15 AM	1	0	0	1
6:30 AM	3	0	0	3
6:45 AM	9	0	0	9
7:00 AM	13	0	0	13
7:15 AM	23	0	1	24
7:30 AM	16	0	1	17
7:45 AM	23	0	0	23
8:00 AM	26	0	0	26
8:15 AM	26	0	2	28
8:30 AM	28	0	0	28
8:45 AM	36	0	0	36
9:00 AM	48	0	1	49
9:15 AM	41	0	0	41
9:30 AM	38	0	3	41
9:45 AM	40	0	1	41
10:00 AM	36	0	3	39

10:15 AM  
 10:30 AM  
 10:45 AM  
 11:00 AM  
 11:15 AM  
 11:30 AM  
 11:45 AM  
 12:00 PM  
 12:15 PM  
 12:30 PM  
 12:45 PM  
 1:00 PM  
 1:15 PM  
 1:30 PM  
 1:45 PM  
 2:00 PM  
 2:15 PM  
 2:30 PM  
 2:45 PM  
 3:00 PM  
 3:15 PM  
 3:30 PM  
 3:45 PM  
 4:00 PM  
 4:15 PM  
 4:30 PM  
 4:45 PM  
 5:00 PM  
 5:15 PM  
 5:30 PM  
 5:45 PM  
 6:00 PM  
 6:15 PM  
 6:30 PM  
 6:45 PM  
 7:00 PM  
 7:15 PM  
 7:30 PM  
 7:45 PM  
 8:00 PM  
 8:15 PM  
 8:30 PM  
 8:45 PM  
 9:00 PM  
 9:15 PM  
 9:30 PM  
 9:45 PM  
 10:00 PM  
 10:15 PM  
 10:30 PM  
 10:45 PM  
 11:00 PM

25	0	1	26
29	0	4	33
13	0	1	14
23	0	1	24
19	0	1	20
26	0	3	29
15	0	1	16
18	0	2	20
26	0	0	26
28	0	1	29
36	0	2	38
28	0	0	28
27	0	0	27
29	0	1	30
20	0	0	20
15	0	0	15
30	0	0	30
25	0	2	27
26	0	4	30
8	0	1	9
12	0	0	12
25	0	0	25
19	0	3	22
15	0	1	16
17	0	1	18
14	0	2	16
17	0	1	18
11	0	0	11
13	0	1	14
9	0	1	10
14	0	4	18
9	0	0	9
14	0	0	14
15	0	0	15
7	0	0	7
10	0	0	10
3	0	0	3
5	0	1	6
8	0	0	8
12	0	0	12
4	0	0	4
8	0	0	8
6	0	0	6
2	0	0	2
2	0	0	2
4	0	0	4
3	0	0	3
8	0	0	8
2	0	0	2
3	0	0	3
2	0	0	2
3	0	0	3

11:15 PM	2	0	0	2
11:30 PM	2	0	0	2
11:45 PM	2	0	0	2
Total	1197	0	54	1251
Total %	95.7	0.0	4.3	100.0
AM Times	9:00 AM	12:00 AM	9:45 AM	9:00 AM
AM Peaks	167	0	9	172
PM Times	12:30 PM	12:00 PM	2:15 PM	12:30 PM
PM Peaks	119	0	7	122

A & P Consulting Transportation  
10305 Nw 41St St., Suite 115  
Miami, Florida, United States 33178  
(305)592-7283 edsanchez@apcte.com

Count Name: Aurora Street between Altara  
Avenue and SR 976Bird Road FC North  
Thursday  
Site Code: Aurora Street between Altara Avenue  
and SR 976Bird  
Start Date: 01/23/2020  
Page No: 7

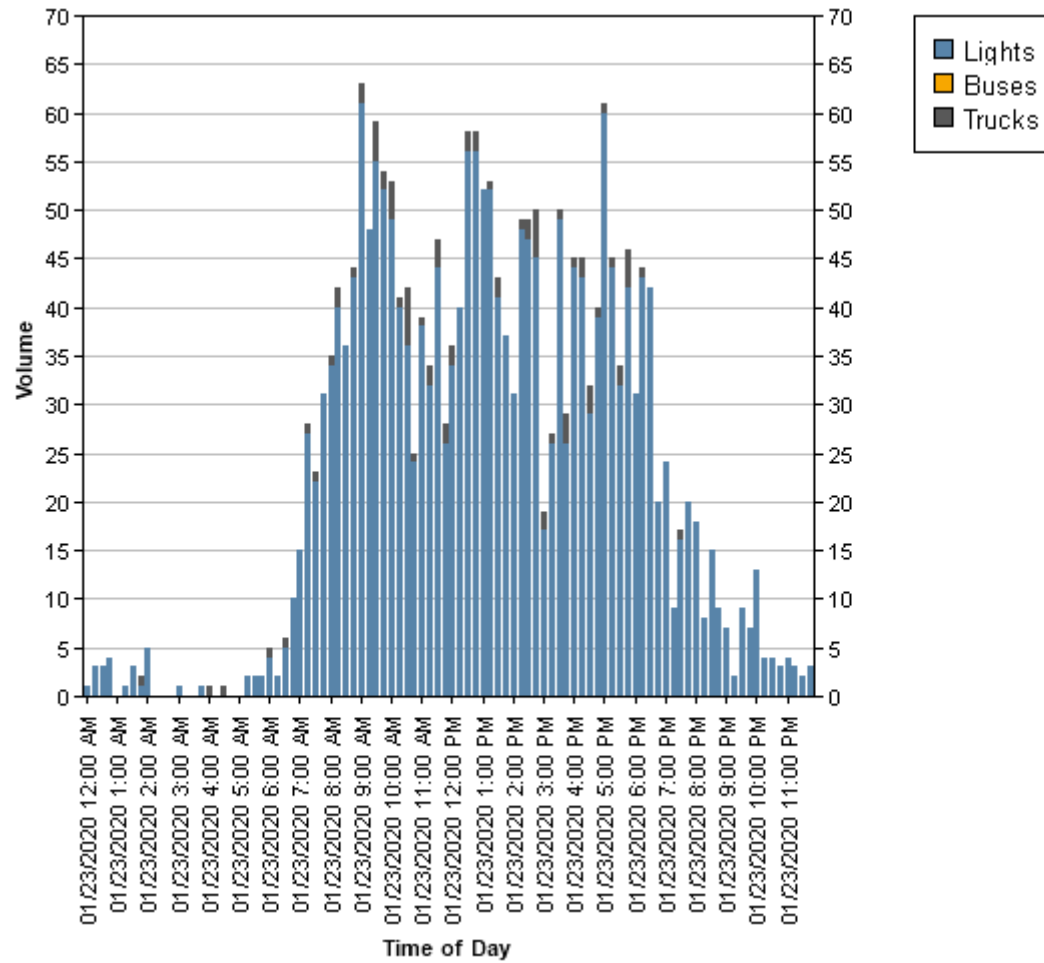

A & P Consulting Transportation  
10305 Nw 41St St., Suite 115  
Miami, Florida, United States 33178  
(305)592-7283 edsanchez@apcte.com

Count Name: Aurora Street between Altara  
Avenue and SR 976Bird Road FC North  
Thursday  
Site Code: Aurora Street between Altara Avenue  
and SR 976Bird  
Start Date: 01/23/2020  
Page No: 8

A & P Consulting Transportation  
 10305 Nw 41St St., Suite 115  
 Miami, Florida, United States 33178  
 (305)592-7283 edsanchez@apcte.com

Count Name: Altara Avenue between SR  
 953LeJeune Road and Ponce De Leon  
 Boulevard Tuesday  
 Site Code: Altara Avenue between SR  
 953LeJeune Road and Ponce  
 Start Date: 01/21/2020  
 Page No: 1

**Direction (Westbound)**

Start Time	Lights	Buses	Trucks	Total
01/21/2020 12:00 AM	5	0	0	5
12:15 AM	3	0	0	3
12:30 AM	1	0	0	1
12:45 AM	3	0	0	3
1:00 AM	4	0	0	4
1:15 AM	1	0	0	1
1:30 AM	1	0	0	1
1:45 AM	2	0	0	2
2:00 AM	0	0	0	0
2:15 AM	1	0	0	1
2:30 AM	1	0	0	1
2:45 AM	0	0	0	0
3:00 AM	0	0	0	0
3:15 AM	1	0	0	1
3:30 AM	0	0	0	0
3:45 AM	0	0	0	0
4:00 AM	1	0	1	2
4:15 AM	0	0	0	0
4:30 AM	1	0	0	1
4:45 AM	1	0	0	1
5:00 AM	2	0	0	2
5:15 AM	2	0	0	2
5:30 AM	1	0	0	1
5:45 AM	1	0	0	1
6:00 AM	2	0	0	2
6:15 AM	10	0	0	10
6:30 AM	24	0	0	24
6:45 AM	50	0	0	50
7:00 AM	66	0	0	66
7:15 AM	32	0	0	32
7:30 AM	13	0	0	13
7:45 AM	31	0	0	31
8:00 AM	11	0	1	12
8:15 AM	20	0	0	20
8:30 AM	27	0	1	28
8:45 AM	18	0	0	18
9:00 AM	47	0	0	47
9:15 AM	27	0	0	27
9:30 AM	24	0	1	25
9:45 AM	28	0	0	28
10:00 AM	34	0	1	35



10:15 AM  
10:30 AM  
10:45 AM  
11:00 AM  
11:15 AM  
11:30 AM  
11:45 AM  
12:00 PM  
12:15 PM  
12:30 PM  
12:45 PM  
1:00 PM  
1:15 PM  
1:30 PM  
1:45 PM  
2:00 PM  
2:15 PM  
2:30 PM  
2:45 PM  
3:00 PM  
3:15 PM  
3:30 PM  
3:45 PM  
4:00 PM  
4:15 PM  
4:30 PM  
4:45 PM  
5:00 PM  
5:15 PM  
5:30 PM  
5:45 PM  
6:00 PM  
6:15 PM  
6:30 PM  
6:45 PM  
7:00 PM  
7:15 PM  
7:30 PM  
7:45 PM  
8:00 PM  
8:15 PM  
8:30 PM  
8:45 PM  
9:00 PM  
9:15 PM  
9:30 PM  
9:45 PM  
10:00 PM  
10:15 PM  
10:30 PM  
10:45 PM  
11:00 PM

35	0	0	35
27	0	0	27
34	0	1	35
27	0	0	27
28	0	2	30
43	0	2	45
38	0	1	39
39	0	0	39
31	0	1	32
32	0	1	33
23	0	0	23
32	0	2	34
37	0	2	39
36	0	0	36
45	0	2	47
36	0	0	36
35	1	0	36
41	0	1	42
46	0	0	46
46	0	0	46
49	0	0	49
50	0	0	50
33	0	1	34
51	0	0	51
31	0	0	31
44	0	1	45
50	0	0	50
59	0	0	59
41	0	0	41
52	0	0	52
47	0	0	47
49	0	0	49
48	0	0	48
46	0	0	46
36	0	0	36
32	0	0	32
37	0	0	37
28	0	0	28
38	0	0	38
27	0	1	28
26	0	0	26
20	0	0	20
17	0	0	17
19	0	0	19
19	0	0	19
21	0	0	21
6	0	0	6
15	0	0	15
14	0	0	14
16	0	0	16
8	0	0	8
11	0	0	11

11:15 PM	9	0	0	9
11:30 PM	3	0	0	3
11:45 PM	3	0	0	3
Total	2262	1	23	2286
Total %	99.0	0.0	1.0	100.0
AM Times	6:30 AM	6:00 AM	10:45 AM	6:30 AM
AM Peaks	172	0	5	172
PM Times	4:15 PM	1:30 PM	1:00 PM	4:15 PM
PM Peaks	184	1	6	185

A & P Consulting Transportation  
 10305 Nw 41St St., Suite 115  
 Miami, Florida, United States 33178  
 (305)592-7283 edsanchez@apcte.com

Count Name: Altara Avenue between SR  
 953LeJeune Road and Ponce De Leon  
 Boulevard Tuesday  
 Site Code: Altara Avenue between SR  
 953LeJeune Road and Ponce  
 Start Date: 01/21/2020  
 Page No: 4

**Direction (Eastbound)**

Start Time	Lights	Buses	Trucks	Total
01/21/2020 12:00 AM	3	0	0	3
12:15 AM	0	0	0	0
12:30 AM	2	0	0	2
12:45 AM	0	0	0	0
1:00 AM	0	0	0	0
1:15 AM	0	0	0	0
1:30 AM	1	0	0	1
1:45 AM	0	0	0	0
2:00 AM	1	0	0	1
2:15 AM	1	0	0	1
2:30 AM	0	0	1	1
2:45 AM	0	0	0	0
3:00 AM	0	0	0	0
3:15 AM	0	0	0	0
3:30 AM	0	0	0	0
3:45 AM	0	0	0	0
4:00 AM	0	0	0	0
4:15 AM	0	0	0	0
4:30 AM	0	0	0	0
4:45 AM	1	0	0	1
5:00 AM	3	0	0	3
5:15 AM	3	0	0	3
5:30 AM	8	0	0	8
5:45 AM	7	0	0	7
6:00 AM	6	0	0	6
6:15 AM	7	0	0	7
6:30 AM	15	0	0	15
6:45 AM	43	1	0	44
7:00 AM	78	0	0	78
7:15 AM	43	0	0	43
7:30 AM	13	0	0	13
7:45 AM	24	0	0	24
8:00 AM	16	0	0	16
8:15 AM	27	0	0	27
8:30 AM	25	0	0	25
8:45 AM	30	0	0	30
9:00 AM	36	0	0	36
9:15 AM	40	0	2	42
9:30 AM	24	0	0	24
9:45 AM	23	0	2	25
10:00 AM	40	0	2	42

10:15 AM  
10:30 AM  
10:45 AM  
11:00 AM  
11:15 AM  
11:30 AM  
11:45 AM  
12:00 PM  
12:15 PM  
12:30 PM  
12:45 PM  
1:00 PM  
1:15 PM  
1:30 PM  
1:45 PM  
2:00 PM  
2:15 PM  
2:30 PM  
2:45 PM  
3:00 PM  
3:15 PM  
3:30 PM  
3:45 PM  
4:00 PM  
4:15 PM  
4:30 PM  
4:45 PM  
5:00 PM  
5:15 PM  
5:30 PM  
5:45 PM  
6:00 PM  
6:15 PM  
6:30 PM  
6:45 PM  
7:00 PM  
7:15 PM  
7:30 PM  
7:45 PM  
8:00 PM  
8:15 PM  
8:30 PM  
8:45 PM  
9:00 PM  
9:15 PM  
9:30 PM  
9:45 PM  
10:00 PM  
10:15 PM  
10:30 PM  
10:45 PM  
11:00 PM

22	0	0	22
21	1	0	22
32	0	0	32
25	0	1	26
19	0	2	21
36	0	1	37
24	0	0	24
28	0	1	29
26	0	0	26
30	0	0	30
27	0	0	27
28	0	0	28
17	0	1	18
18	0	0	18
31	0	1	32
34	0	0	34
46	0	1	47
50	0	0	50
27	0	0	27
26	0	0	26
29	0	1	30
32	0	0	32
23	0	1	24
25	0	1	26
45	0	0	45
35	0	1	36
34	0	0	34
34	0	0	34
21	0	0	21
23	0	0	23
36	0	0	36
23	0	0	23
29	0	0	29
38	0	0	38
18	0	0	18
29	0	0	29
28	0	0	28
28	0	0	28
24	0	0	24
13	0	0	13
15	0	0	15
21	0	0	21
18	0	0	18
21	0	0	21
14	0	0	14
7	0	0	7
13	0	0	13
2	0	0	2
7	0	0	7
4	0	0	4
6	0	0	6
2	0	0	2

11:15 PM	3	0	0	3
11:30 PM	4	0	0	4
11:45 PM	3	0	0	3
Total	1794	2	19	1815
Total %	98.8	0.1	1.0	100.0
AM Times	6:30 AM	6:00 AM	10:45 AM	6:30 AM
AM Peaks	179	1	4	180
PM Times	4:15 PM	1:30 PM	1:00 PM	4:15 PM
PM Peaks	148	0	2	149

A & P Consulting Transportation  
10305 Nw 41St St., Suite 115  
Miami, Florida, United States 33178  
(305)592-7283 edsanchez@apcte.com

Count Name: Altara Avenue between SR  
953LeJeune Road and Ponce De Leon  
Boulevard Tuesday  
Site Code: Altara Avenue between SR  
953LeJeune Road and Ponce  
Start Date: 01/21/2020  
Page No: 7

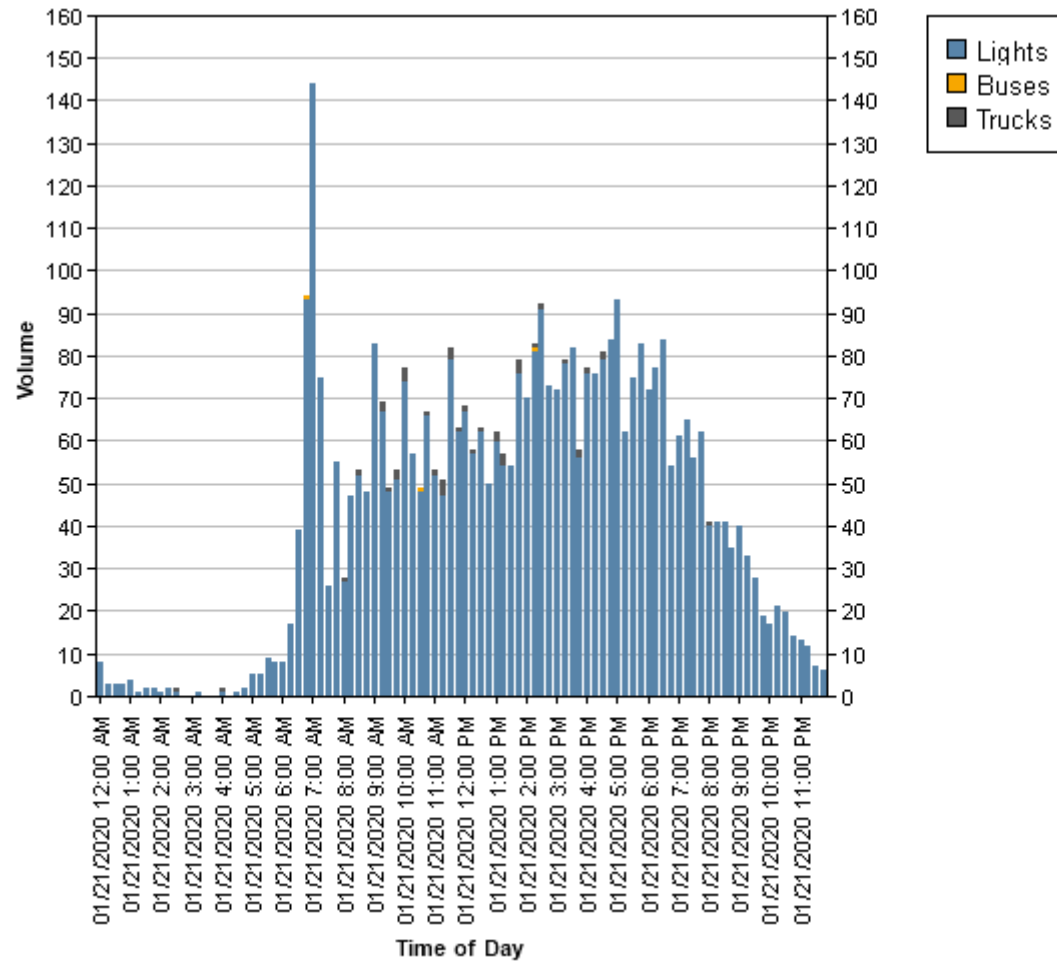

A & P Consulting Transportation  
10305 Nw 41St St., Suite 115  
Miami, Florida, United States 33178  
(305)592-7283 edsanchez@apcte.com

Count Name: Altara Avenue between SR  
953LeJeune Road and Ponce De Leon  
Boulevard Tuesday  
Site Code: Altara Avenue between SR  
953LeJeune Road and Ponce  
Start Date: 01/21/2020  
Page No: 8

A & P Consulting Transportation  
 10305 Nw 41St St., Suite 115  
 Miami, Florida, United States 33178  
 (305)592-7283 edsanchez@apcte.com

Count Name: Altara Avenue between SR  
 953LeJeune Road and Ponce De Leon  
 Boulevard Thursday  
 Site Code: Altara Avenue between SR  
 953LeJeune Road and Ponce  
 Start Date: 01/23/2020  
 Page No: 1

**Direction (Westbound)**

Start Time	Lights	Buses	Trucks	Total
01/23/2020 12:00 AM	4	0	0	4
12:15 AM	8	0	0	8
12:30 AM	4	0	0	4
12:45 AM	6	0	0	6
1:00 AM	1	0	0	1
1:15 AM	5	0	0	5
1:30 AM	5	0	0	5
1:45 AM	0	0	0	0
2:00 AM	2	0	0	2
2:15 AM	1	0	0	1
2:30 AM	1	0	0	1
2:45 AM	0	0	0	0
3:00 AM	1	0	0	1
3:15 AM	0	0	0	0
3:30 AM	0	0	0	0
3:45 AM	0	0	1	1
4:00 AM	1	0	0	1
4:15 AM	0	0	0	0
4:30 AM	1	0	1	2
4:45 AM	2	0	0	2
5:00 AM	2	0	0	2
5:15 AM	2	0	1	3
5:30 AM	3	0	0	3
5:45 AM	2	0	1	3
6:00 AM	4	0	0	4
6:15 AM	4	0	1	5
6:30 AM	28	0	1	29
6:45 AM	41	0	0	41
7:00 AM	58	0	0	58
7:15 AM	24	0	0	24
7:30 AM	17	0	0	17
7:45 AM	15	0	0	15
8:00 AM	14	0	1	15
8:15 AM	22	0	0	22
8:30 AM	19	0	0	19
8:45 AM	21	0	0	21
9:00 AM	37	0	0	37
9:15 AM	32	0	0	32
9:30 AM	26	0	0	26
9:45 AM	22	0	0	22
10:00 AM	28	0	1	29



10:15 AM  
10:30 AM  
10:45 AM  
11:00 AM  
11:15 AM  
11:30 AM  
11:45 AM  
12:00 PM  
12:15 PM  
12:30 PM  
12:45 PM  
1:00 PM  
1:15 PM  
1:30 PM  
1:45 PM  
2:00 PM  
2:15 PM  
2:30 PM  
2:45 PM  
3:00 PM  
3:15 PM  
3:30 PM  
3:45 PM  
4:00 PM  
4:15 PM  
4:30 PM  
4:45 PM  
5:00 PM  
5:15 PM  
5:30 PM  
5:45 PM  
6:00 PM  
6:15 PM  
6:30 PM  
6:45 PM  
7:00 PM  
7:15 PM  
7:30 PM  
7:45 PM  
8:00 PM  
8:15 PM  
8:30 PM  
8:45 PM  
9:00 PM  
9:15 PM  
9:30 PM  
9:45 PM  
10:00 PM  
10:15 PM  
10:30 PM  
10:45 PM  
11:00 PM

29	0	0	29
41	0	2	43
33	0	0	33
31	0	1	32
31	0	2	33
36	0	1	37
26	0	2	28
41	0	0	41
32	0	0	32
26	0	2	28
23	0	0	23
36	0	0	36
36	0	0	36
44	0	1	45
37	0	0	37
29	0	0	29
32	0	0	32
45	0	1	46
47	0	0	47
44	0	0	44
44	0	1	45
49	0	0	49
40	0	0	40
47	0	1	48
37	0	0	37
52	0	0	52
43	0	0	43
54	0	1	55
36	0	0	36
45	0	0	45
42	0	0	42
39	0	0	39
38	0	0	38
45	0	0	45
42	0	0	42
40	0	0	40
25	0	0	25
25	0	0	25
43	0	0	43
25	0	0	25
20	0	0	20
31	0	0	31
17	0	0	17
19	0	0	19
19	0	1	20
26	0	0	26
20	0	0	20
16	0	0	16
18	0	0	18
21	0	0	21
17	0	0	17
10	0	0	10

11:15 PM	5	0	0	5
11:30 PM	4	0	0	4
11:45 PM	3	0	0	3
Total	2219	0	24	2243
Total %	98.9	0.0	1.1	100.0
AM Times	6:30 AM	9:45 AM	11:00 AM	6:30 AM
AM Peaks	151	0	6	152
PM Times	2:30 PM	12:00 PM	12:00 PM	2:30 PM
PM Peaks	180	0	2	182

A & P Consulting Transportation  
 10305 Nw 41St St., Suite 115  
 Miami, Florida, United States 33178  
 (305)592-7283 edsanchez@apcte.com

Count Name: Altara Avenue between SR  
 953LeJeune Road and Ponce De Leon  
 Boulevard Thursday  
 Site Code: Altara Avenue between SR  
 953LeJeune Road and Ponce  
 Start Date: 01/23/2020  
 Page No: 4

**Direction (Eastbound)**

Start Time	Lights	Buses	Trucks	Total
01/23/2020 12:00 AM	2	0	0	2
12:15 AM	1	0	0	1
12:30 AM	0	0	0	0
12:45 AM	4	0	0	4
1:00 AM	2	0	0	2
1:15 AM	2	0	0	2
1:30 AM	2	0	0	2
1:45 AM	0	0	0	0
2:00 AM	1	0	0	1
2:15 AM	1	0	0	1
2:30 AM	1	0	0	1
2:45 AM	0	0	0	0
3:00 AM	0	0	0	0
3:15 AM	0	0	0	0
3:30 AM	0	0	0	0
3:45 AM	0	0	0	0
4:00 AM	1	0	1	2
4:15 AM	0	0	0	0
4:30 AM	0	0	0	0
4:45 AM	4	0	0	4
5:00 AM	3	0	2	5
5:15 AM	6	0	2	8
5:30 AM	6	0	0	6
5:45 AM	6	0	0	6
6:00 AM	7	0	0	7
6:15 AM	7	0	0	7
6:30 AM	13	0	1	14
6:45 AM	33	0	0	33
7:00 AM	85	0	0	85
7:15 AM	44	0	1	45
7:30 AM	11	0	0	11
7:45 AM	21	0	0	21
8:00 AM	23	0	1	24
8:15 AM	27	0	0	27
8:30 AM	23	0	0	23
8:45 AM	32	0	2	34
9:00 AM	34	0	1	35
9:15 AM	31	0	1	32
9:30 AM	36	0	1	37
9:45 AM	29	0	2	31
10:00 AM	35	0	3	38

10:15 AM  
10:30 AM  
10:45 AM  
11:00 AM  
11:15 AM  
11:30 AM  
11:45 AM  
12:00 PM  
12:15 PM  
12:30 PM  
12:45 PM  
1:00 PM  
1:15 PM  
1:30 PM  
1:45 PM  
2:00 PM  
2:15 PM  
2:30 PM  
2:45 PM  
3:00 PM  
3:15 PM  
3:30 PM  
3:45 PM  
4:00 PM  
4:15 PM  
4:30 PM  
4:45 PM  
5:00 PM  
5:15 PM  
5:30 PM  
5:45 PM  
6:00 PM  
6:15 PM  
6:30 PM  
6:45 PM  
7:00 PM  
7:15 PM  
7:30 PM  
7:45 PM  
8:00 PM  
8:15 PM  
8:30 PM  
8:45 PM  
9:00 PM  
9:15 PM  
9:30 PM  
9:45 PM  
10:00 PM  
10:15 PM  
10:30 PM  
10:45 PM  
11:00 PM

22	0	2	24
26	1	0	27
33	0	1	34
37	0	1	38
25	0	1	26
24	0	1	25
27	0	2	29
40	0	3	43
41	0	0	41
25	0	0	25
27	0	0	27
25	0	0	25
19	0	1	20
27	0	0	27
28	0	2	30
31	0	0	31
44	0	0	44
47	0	0	47
39	0	2	41
33	0	0	33
40	0	0	40
33	0	0	33
37	0	0	37
31	0	0	31
38	0	0	38
35	0	0	35
30	0	0	30
28	0	1	29
33	0	0	33
25	0	0	25
32	0	1	33
47	0	0	47
38	0	0	38
45	0	0	45
33	0	0	33
17	0	0	17
26	0	0	26
20	0	0	20
20	0	0	20
20	0	0	20
15	0	0	15
6	0	0	6
15	0	0	15
12	0	0	12
4	0	0	4
6	0	0	6
5	0	0	5
7	0	0	7
8	0	0	8
7	0	0	7
6	0	0	6
4	0	0	4

11:15 PM	10	0	0	10
11:30 PM	4	0	0	4
11:45 PM	3	0	0	3
Total	1893	1	36	1930
Total %	98.1	0.1	1.9	100.0
AM Times	6:30 AM	9:45 AM	11:00 AM	6:30 AM
AM Peaks	175	1	5	177
PM Times	2:30 PM	12:00 PM	12:00 PM	2:30 PM
PM Peaks	159	0	3	161

A & P Consulting Transportation  
10305 Nw 41St St., Suite 115  
Miami, Florida, United States 33178  
(305)592-7283 edsanchez@apcte.com

Count Name: Altara Avenue between SR  
953LeJeune Road and Ponce De Leon  
Boulevard Thursday  
Site Code: Altara Avenue between SR  
953LeJeune Road and Ponce  
Start Date: 01/23/2020  
Page No: 7

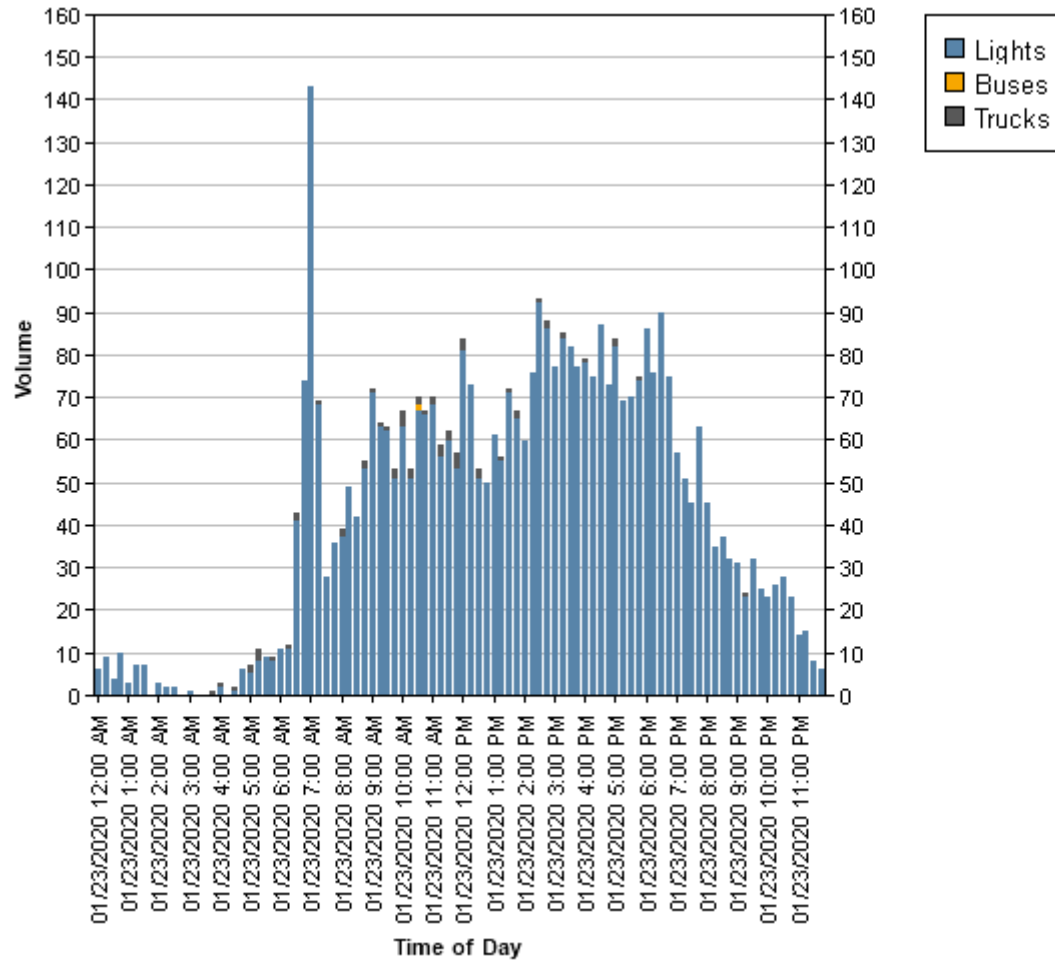

A & P Consulting Transportation  
10305 Nw 41St St., Suite 115  
Miami, Florida, United States 33178  
(305)592-7283 edsanchez@apcte.com

Count Name: Altara Avenue between SR  
953LeJeune Road and Ponce De Leon  
Boulevard Thursday  
Site Code: Altara Avenue between SR  
953LeJeune Road and Ponce  
Start Date: 01/23/2020  
Page No: 8

A & P Consulting Transportation  
 10305 Nw 41St St., Suite 115  
 Miami, Florida, United States 33178  
 (305)592-7283 edsanchez@apcte.com

Count Name: Altara Avenue between SR  
 953LeJeune Road and Ponce De Leon  
 Boulevard Wednesday  
 Site Code: Altara Avenue between SR  
 953LeJeune Road and Ponce  
 Start Date: 01/22/2020  
 Page No: 1

**Direction (Westbound)**

Start Time	Lights	Buses	Trucks	Total
01/22/2020 12:00 AM	3	0	0	3
12:15 AM	5	0	0	5
12:30 AM	1	0	0	1
12:45 AM	2	0	0	2
1:00 AM	1	0	0	1
1:15 AM	1	0	0	1
1:30 AM	1	0	0	1
1:45 AM	2	0	1	3
2:00 AM	1	0	0	1
2:15 AM	1	0	0	1
2:30 AM	0	0	0	0
2:45 AM	0	0	0	0
3:00 AM	0	0	0	0
3:15 AM	0	0	0	0
3:30 AM	1	0	1	2
3:45 AM	0	0	0	0
4:00 AM	1	0	0	1
4:15 AM	1	0	0	1
4:30 AM	0	0	1	1
4:45 AM	0	0	1	1
5:00 AM	2	0	0	2
5:15 AM	2	0	0	2
5:30 AM	1	0	0	1
5:45 AM	2	0	0	2
6:00 AM	8	0	0	8
6:15 AM	7	0	0	7
6:30 AM	20	0	0	20
6:45 AM	51	0	0	51
7:00 AM	56	0	0	56
7:15 AM	45	0	1	46
7:30 AM	24	0	2	26
7:45 AM	31	0	1	32
8:00 AM	20	0	1	21
8:15 AM	23	0	0	23
8:30 AM	33	0	0	33
8:45 AM	35	0	0	35
9:00 AM	29	0	0	29
9:15 AM	22	0	0	22
9:30 AM	23	0	0	23
9:45 AM	23	0	1	24
10:00 AM	17	0	1	18



10:15 AM  
10:30 AM  
10:45 AM  
11:00 AM  
11:15 AM  
11:30 AM  
11:45 AM  
12:00 PM  
12:15 PM  
12:30 PM  
12:45 PM  
1:00 PM  
1:15 PM  
1:30 PM  
1:45 PM  
2:00 PM  
2:15 PM  
2:30 PM  
2:45 PM  
3:00 PM  
3:15 PM  
3:30 PM  
3:45 PM  
4:00 PM  
4:15 PM  
4:30 PM  
4:45 PM  
5:00 PM  
5:15 PM  
5:30 PM  
5:45 PM  
6:00 PM  
6:15 PM  
6:30 PM  
6:45 PM  
7:00 PM  
7:15 PM  
7:30 PM  
7:45 PM  
8:00 PM  
8:15 PM  
8:30 PM  
8:45 PM  
9:00 PM  
9:15 PM  
9:30 PM  
9:45 PM  
10:00 PM  
10:15 PM  
10:30 PM  
10:45 PM  
11:00 PM

32	0	1	33
36	0	0	36
38	0	0	38
33	0	0	33
37	0	1	38
27	0	2	29
25	0	0	25
37	0	3	40
27	0	0	27
30	0	1	31
30	0	3	33
42	0	1	43
45	0	2	47
31	0	2	33
27	0	2	29
49	0	0	49
48	0	1	49
56	0	0	56
41	0	2	43
57	0	0	57
43	0	0	43
49	0	0	49
45	0	1	46
41	0	0	41
38	0	2	40
59	0	0	59
37	0	0	37
64	0	0	64
49	0	0	49
43	0	0	43
58	0	0	58
58	0	0	58
58	0	0	58
39	0	0	39
44	0	0	44
36	0	0	36
45	0	0	45
42	0	0	42
18	0	0	18
43	0	0	43
33	0	0	33
29	0	0	29
28	0	0	28
30	0	0	30
21	0	0	21
21	0	1	22
18	0	0	18
17	0	0	17
16	0	0	16
5	0	0	5
4	0	0	4
14	0	0	14

11:15 PM	14	0	0	14
11:30 PM	5	0	0	5
11:45 PM	4	0	0	4
Total	2411	0	36	2447
Total %	98.5	0.0	1.5	100.0
AM Times	6:45 AM	5:45 AM	10:45 AM	6:45 AM
AM Peaks	176	0	3	179
PM Times	5:30 PM	12:00 PM	1:00 PM	5:30 PM
PM Peaks	217	0	7	217

A & P Consulting Transportation  
 10305 Nw 41St St., Suite 115  
 Miami, Florida, United States 33178  
 (305)592-7283 edsanchez@apcte.com

Count Name: Altara Avenue between SR  
 953LeJeune Road and Ponce De Leon  
 Boulevard Wednesday  
 Site Code: Altara Avenue between SR  
 953LeJeune Road and Ponce  
 Start Date: 01/22/2020  
 Page No: 4

**Direction (Eastbound)**

Start Time	Lights	Buses	Trucks	Total
01/22/2020 12:00 AM	4	0	0	4
12:15 AM	3	0	0	3
12:30 AM	2	0	0	2
12:45 AM	2	0	0	2
1:00 AM	3	0	0	3
1:15 AM	3	0	0	3
1:30 AM	0	0	0	0
1:45 AM	2	0	1	3
2:00 AM	0	0	0	0
2:15 AM	0	0	0	0
2:30 AM	0	0	0	0
2:45 AM	0	0	0	0
3:00 AM	0	0	0	0
3:15 AM	0	0	0	0
3:30 AM	0	0	0	0
3:45 AM	0	0	0	0
4:00 AM	0	0	0	0
4:15 AM	0	0	0	0
4:30 AM	2	0	0	2
4:45 AM	1	0	0	1
5:00 AM	2	0	0	2
5:15 AM	5	0	0	5
5:30 AM	2	0	0	2
5:45 AM	7	0	0	7
6:00 AM	6	0	0	6
6:15 AM	11	0	0	11
6:30 AM	13	1	0	14
6:45 AM	38	0	0	38
7:00 AM	77	0	0	77
7:15 AM	42	0	0	42
7:30 AM	12	0	0	12
7:45 AM	4	0	0	4
8:00 AM	16	0	0	16
8:15 AM	16	1	0	17
8:30 AM	25	0	1	26
8:45 AM	27	0	0	27
9:00 AM	36	0	1	37
9:15 AM	31	0	2	33
9:30 AM	35	0	1	36
9:45 AM	21	0	0	21
10:00 AM	28	0	3	31

10:15 AM  
10:30 AM  
10:45 AM  
11:00 AM  
11:15 AM  
11:30 AM  
11:45 AM  
12:00 PM  
12:15 PM  
12:30 PM  
12:45 PM  
1:00 PM  
1:15 PM  
1:30 PM  
1:45 PM  
2:00 PM  
2:15 PM  
2:30 PM  
2:45 PM  
3:00 PM  
3:15 PM  
3:30 PM  
3:45 PM  
4:00 PM  
4:15 PM  
4:30 PM  
4:45 PM  
5:00 PM  
5:15 PM  
5:30 PM  
5:45 PM  
6:00 PM  
6:15 PM  
6:30 PM  
6:45 PM  
7:00 PM  
7:15 PM  
7:30 PM  
7:45 PM  
8:00 PM  
8:15 PM  
8:30 PM  
8:45 PM  
9:00 PM  
9:15 PM  
9:30 PM  
9:45 PM  
10:00 PM  
10:15 PM  
10:30 PM  
10:45 PM  
11:00 PM

20	0	0	20
25	1	1	27
20	0	2	22
27	0	1	28
27	0	3	30
21	0	1	22
25	0	0	25
30	0	0	30
40	0	0	40
35	0	1	36
42	0	0	42
36	0	0	36
27	0	0	27
35	0	0	35
37	0	2	39
24	0	0	24
44	0	0	44
48	0	0	48
31	0	1	32
34	0	0	34
35	0	2	37
39	0	0	39
27	0	0	27
22	0	4	26
29	0	1	30
33	0	0	33
35	0	0	35
45	0	0	45
39	0	1	40
34	0	1	35
35	0	1	36
39	0	0	39
58	0	0	58
33	0	0	33
32	0	0	32
32	0	0	32
19	0	0	19
26	0	0	26
19	0	0	19
23	0	0	23
18	0	0	18
16	0	0	16
13	0	0	13
20	0	0	20
16	0	0	16
10	0	0	10
14	0	0	14
10	0	0	10
7	0	0	7
13	0	0	13
4	0	0	4
8	0	0	8

11:15 PM	4	0	0	4
11:30 PM	5	0	0	5
11:45 PM	0	0	0	0
Total	1916	3	31	1950
Total %	98.3	0.2	1.6	100.0
AM Times	6:45 AM	5:45 AM	10:45 AM	6:45 AM
AM Peaks	169	1	7	169
PM Times	5:30 PM	12:00 PM	1:00 PM	5:30 PM
PM Peaks	166	0	2	168

A & P Consulting Transportation  
10305 Nw 41St St., Suite 115  
Miami, Florida, United States 33178  
(305)592-7283 edsanchez@apcte.com

Count Name: Altara Avenue between SR  
953LeJeune Road and Ponce De Leon  
Boulevard Wednesday  
Site Code: Altara Avenue between SR  
953LeJeune Road and Ponce  
Start Date: 01/22/2020  
Page No: 7

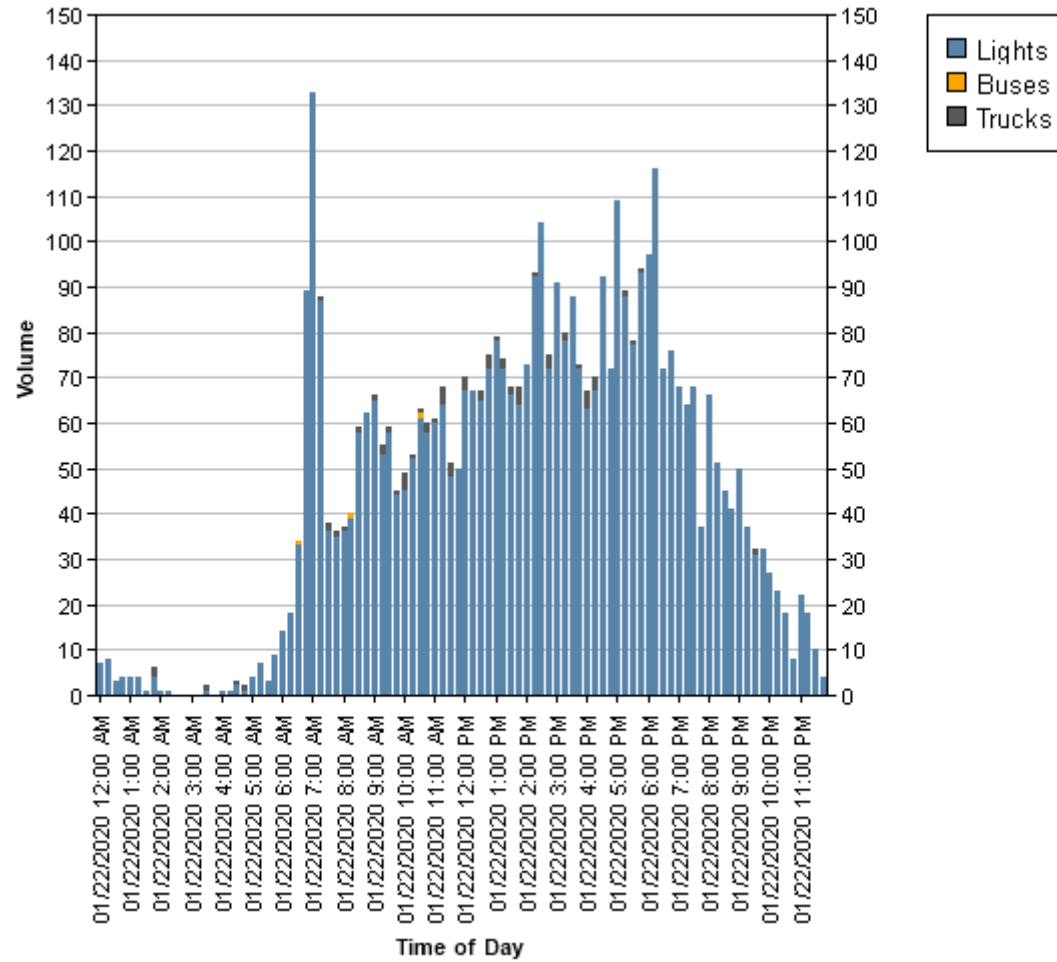

A & P Consulting Transportation  
10305 Nw 41St St., Suite 115  
Miami, Florida, United States 33178  
(305)592-7283 edsanchez@apcte.com

Count Name: Altara Avenue between SR  
953LeJeune Road and Ponce De Leon  
Boulevard Wednesday  
Site Code: Altara Avenue between SR  
953LeJeune Road and Ponce  
Start Date: 01/22/2020  
Page No: 8

## Four-Hour Turning Movement Counts (TMCs)

---



# SR976 Bird Road and Salzedo Street - TMC

Tue Jan 28, 2020

Full Length (7 AM-9 AM, 4 PM-6 PM)

All Classes (Lights, Articulated Trucks and Single-Unit Trucks, Buses, Pedestrians, Bicycles on Crosswalk)

All Movements

ID: 745291, Location: 25.734831, -80.260385, Site Code: SR 976 Bird Road and Salzedo Street



Provided by: Apcte  
10305 NW 41st Street, Suite 115,  
Doral, FL, 33178, US

Leg Direction	SR 976/Bird Road Westbound					Salzedo Street Northbound					SR 976/Bird Road Eastbound					Int
	T	L	U	App	Ped*	R	L	U	App	Ped*	R	T	U	App	Ped*	
2020-01-28 7:00AM	252	1	0	253	1	24	4	0	28	20	2	291	0	293	5	574
7:15AM	208	0	1	209	0	15	4	0	19	8	8	285	0	293	1	521
7:30AM	231	0	0	231	0	0	1	0	1	7	2	342	0	344	2	576
7:45AM	224	0	0	224	4	2	2	0	4	7	5	361	0	366	2	594
Hourly Total	915	1	1	917	5	41	11	0	52	42	17	1279	0	1296	10	2265
8:00AM	292	0	0	292	1	7	2	0	9	4	6	348	0	354	1	655
8:15AM	282	1	0	283	0	7	3	0	10	2	7	385	0	392	0	685
8:30AM	329	0	0	329	0	3	3	0	6	0	1	368	0	369	0	704
8:45AM	295	0	0	295	0	4	4	0	8	2	6	384	0	390	0	693
Hourly Total	1198	1	0	1199	1	21	12	0	33	8	20	1485	0	1505	1	2737
4:00PM	399	0	0	399	0	10	12	0	22	9	12	280	0	292	0	713
4:15PM	395	0	0	395	2	14	7	0	21	7	6	293	0	299	1	715
4:30PM	411	0	0	411	2	9	7	0	16	5	13	269	1	283	1	710
4:45PM	439	0	0	439	1	6	3	0	9	4	13	286	0	299	0	747
Hourly Total	1644	0	0	1644	5	39	29	0	68	25	44	1128	1	1173	2	2885
5:00PM	447	1	0	448	0	8	9	0	17	0	9	267	0	276	1	741
5:15PM	447	0	0	447	0	9	7	0	16	8	13	289	0	302	0	765
5:30PM	403	0	0	403	0	11	5	0	16	5	15	288	1	304	0	723
5:45PM	349	0	0	349	0	13	14	0	27	0	7	278	0	285	1	661
Hourly Total	1646	1	0	1647	0	41	35	0	76	13	44	1122	1	1167	2	2890
<b>Total</b>	5403	3	1	5407	11	142	87	0	229	88	125	5014	2	5141	15	10777
<b>% Approach</b>	99.9%	0.1%	0%	-	-	62.0%	38.0%	0%	-	-	2.4%	97.5%	0%	-	-	-
<b>% Total</b>	50.1%	0%	0%	50.2%	-	1.3%	0.8%	0%	2.1%	-	1.2%	46.5%	0%	47.7%	-	-
<b>Lights</b>	5295	3	1	5299	-	142	86	0	228	-	121	4904	2	5027	-	10554
<b>% Lights</b>	98.0%	100%	100%	98.0%	-	100%	98.9%	0%	99.6%	-	96.8%	97.8%	100%	97.8%	-	97.9%
<b>Articulated Trucks and Single-Unit Trucks</b>	69	0	0	69	-	0	1	0	1	-	4	71	0	75	-	145
<b>% Articulated Trucks and Single-Unit Trucks</b>	1.3%	0%	0%	1.3%	-	0%	1.1%	0%	0.4%	-	3.2%	1.4%	0%	1.5%	-	1.3%
<b>Buses</b>	39	0	0	39	-	0	0	0	0	-	0	39	0	39	-	78
<b>% Buses</b>	0.7%	0%	0%	0.7%	-	0%	0%	0%	0%	-	0%	0.8%	0%	0.8%	-	0.7%
<b>Pedestrians</b>	-	-	-	-	11	-	-	-	-	80	-	-	-	-	-	7
<b>% Pedestrians</b>	-	-	-	-	100%	-	-	-	-	90.9%	-	-	-	-	-	46.7%
<b>Bicycles on Crosswalk</b>	-	-	-	-	0	-	-	-	-	8	-	-	-	-	-	8
<b>% Bicycles on Crosswalk</b>	-	-	-	-	0%	-	-	-	-	9.1%	-	-	-	-	-	53.3%

\* Pedestrians and Bicycles on Crosswalk. L: Left, R: Right, T: Thru, U: U-Turn

**SR976 Bird Road and Salzedo Street - TMC**

Tue Jan 28, 2020

Full Length (7 AM-9 AM, 4 PM-6 PM)

All Classes (Lights, Articulated Trucks and Single-Unit Trucks, Buses, Pedestrians, Bicycles on Crosswalk)

All Movements

ID: 745291, Location: 25.734831, -80.260385, Site Code: SR 976 Bird Road and Salzedo Street



Provided by: Apcte  
10305 NW 41st Street, Suite 115,  
Doral, FL, 33178, US

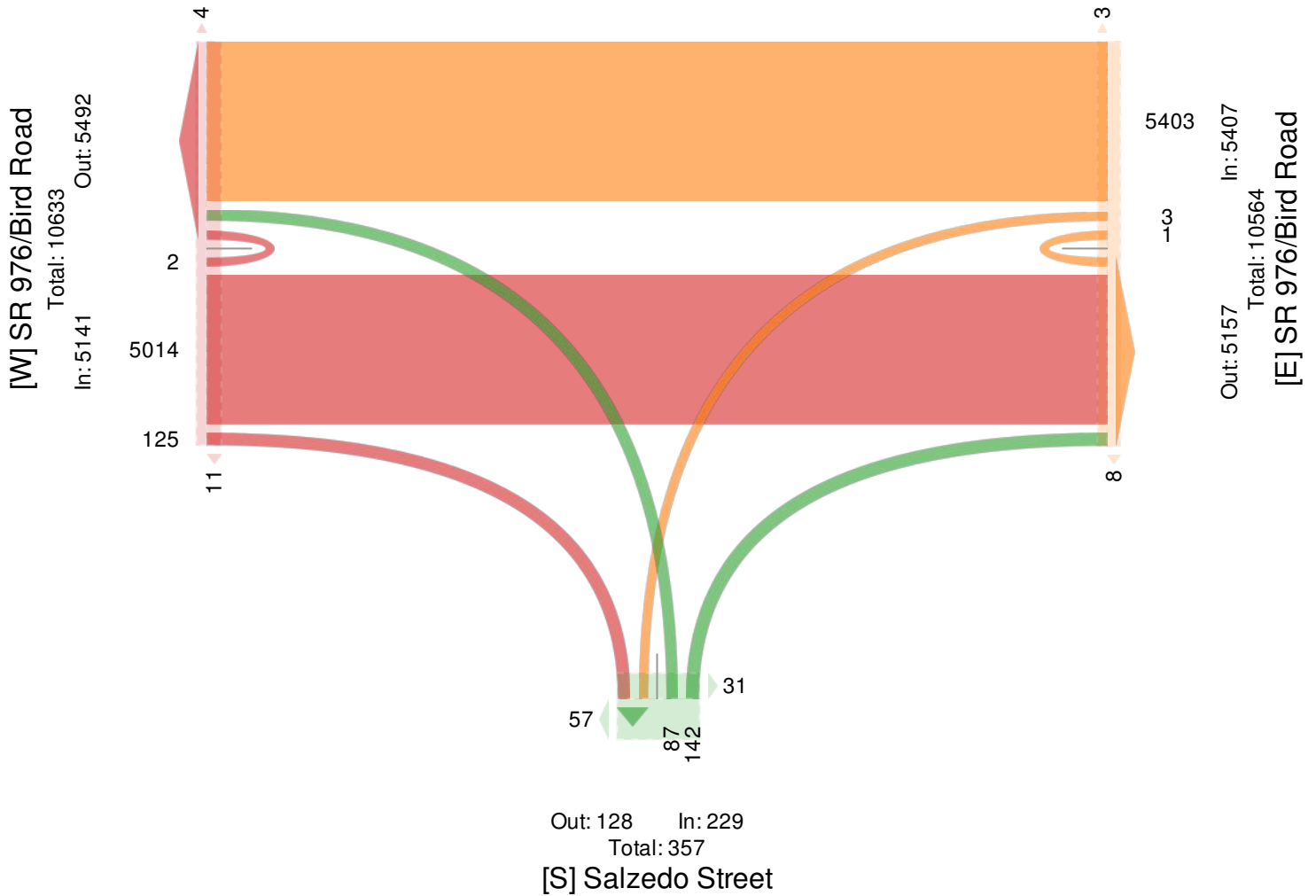

**SR976 Bird Road and Salzedo Street - TMC**

Tue Jan 28, 2020

AM Peak (8 AM - 9 AM)

All Classes (Lights, Articulated Trucks and Single-Unit Trucks, Buses, Pedestrians, Bicycles on Crosswalk)

All Movements

ID: 745291, Location: 25.734831, -80.260385, Site Code: SR 976 Bird Road and Salzedo Street



Provided by: Apcte  
10305 NW 41st Street, Suite 115,  
Doral, FL, 33178, US

Leg Direction	SR 976/Bird Road Westbound					Salzedo Street Northbound					SR 976/Bird Road Eastbound					
Time	T	L	U	App	Ped*	R	L	U	App	Ped*	R	T	U	App	Ped*	Int
2020-01-28 8:00AM	292	0	0	292	1	7	2	0	9	4	6	348	0	354	1	655
8:15AM	282	1	0	283	0	7	3	0	10	2	7	385	0	392	0	685
8:30AM	329	0	0	329	0	3	3	0	6	0	1	368	0	369	0	704
8:45AM	295	0	0	295	0	4	4	0	8	2	6	384	0	390	0	693
<b>Total</b>	1198	1	0	1199	1	21	12	0	33	8	20	1485	0	1505	1	2737
<b>% Approach</b>	99.9%	0.1%	0%	-	-	63.6%	36.4%	0%	-	-	1.3%	98.7%	0%	-	-	-
<b>% Total</b>	43.8%	0%	0%	43.8%	-	0.8%	0.4%	0%	1.2%	-	0.7%	54.3%	0%	55.0%	-	-
<b>PHF</b>	0.910	0.250	-	0.911	-	0.750	0.750	-	0.825	-	0.714	0.964	-	0.960	-	0.972
<b>Lights</b>	1163	1	0	1164	-	21	12	0	33	-	19	1449	0	1468	-	2665
<b>% Lights</b>	97.1%	100%	0%	97.1%	-	100%	100%	0%	100%	-	95.0%	97.6%	0%	97.5%	-	97.4%
<b>Articulated Trucks and Single-Unit Trucks</b>	22	0	0	22	-	0	0	0	0	-	1	28	0	29	-	51
<b>% Articulated Trucks and Single-Unit Trucks</b>	1.8%	0%	0%	1.8%	-	0%	0%	0%	0%	-	5.0%	1.9%	0%	1.9%	-	1.9%
<b>Buses</b>	13	0	0	13	-	0	0	0	0	-	0	8	0	8	-	21
<b>% Buses</b>	1.1%	0%	0%	1.1%	-	0%	0%	0%	0%	-	0%	0.5%	0%	0.5%	-	0.8%
Pedestrians	-	-	-	-	1	-	-	-	-	5	-	-	-	-	0	-
<b>% Pedestrians</b>	-	-	-	-	100%	-	-	-	-	62.5%	-	-	-	-	0%	-
Bicycles on Crosswalk	-	-	-	-	0	-	-	-	-	3	-	-	-	-	1	-
<b>% Bicycles on Crosswalk</b>	-	-	-	-	0%	-	-	-	-	37.5%	-	-	-	-	100%	-

\* Pedestrians and Bicycles on Crosswalk. L: Left, R: Right, T: Thru, U: U-Turn

**SR976 Bird Road and Salzedo Street - TMC**

Tue Jan 28, 2020

AM Peak (8 AM - 9 AM)

All Classes (Lights, Articulated Trucks and Single-Unit Trucks, Buses, Pedestrians, Bicycles on Crosswalk)

All Movements

ID: 745291, Location: 25.734831, -80.260385, Site Code: SR 976 Bird Road and Salzedo Street



Provided by: Apcte  
10305 NW 41st Street, Suite 115,  
Doral, FL, 33178, US

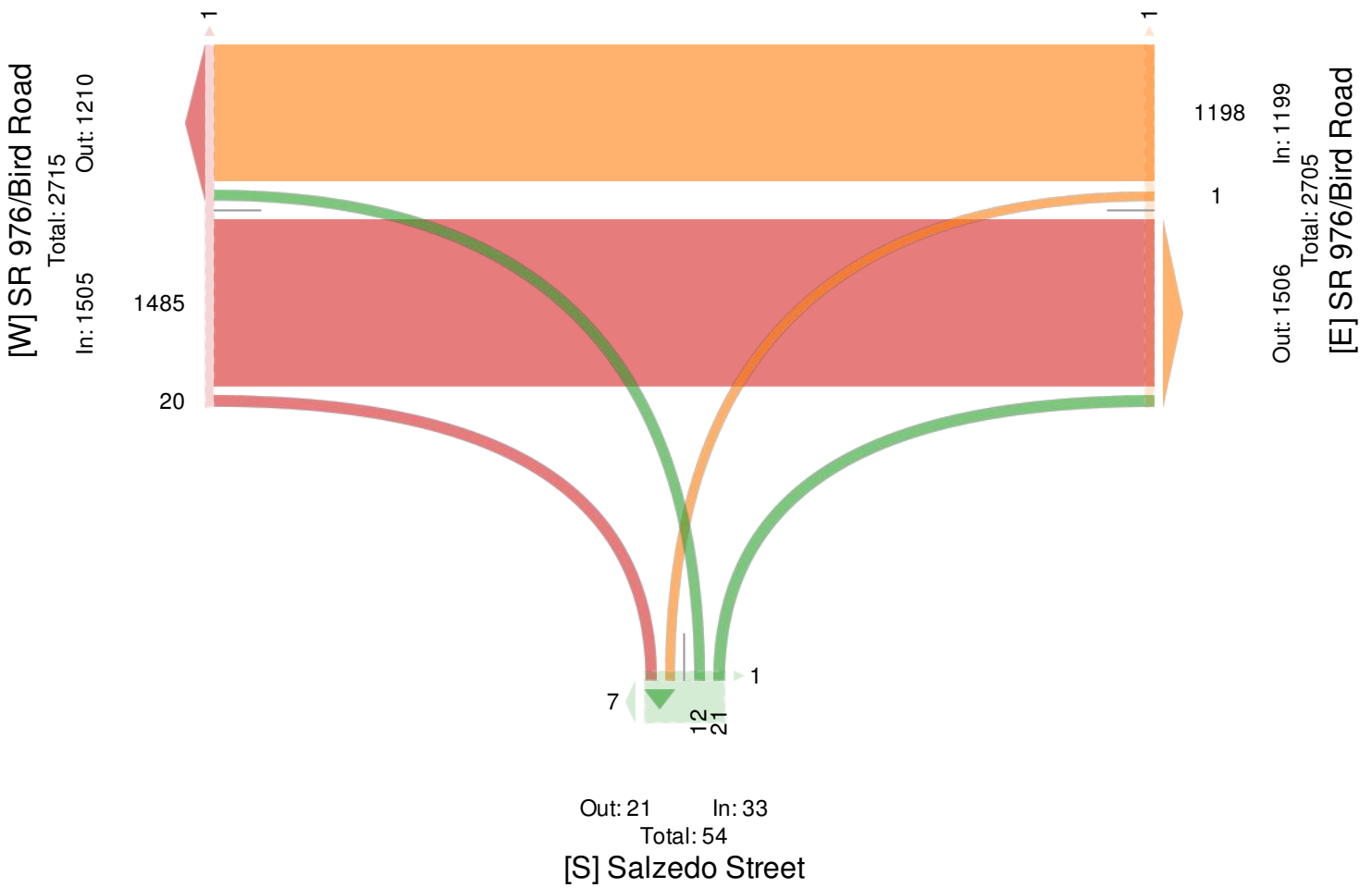

**SR976 Bird Road and Salzedo Street - TMC**

Tue Jan 28, 2020

PM Peak (4:45 PM - 5:45 PM) - Overall Peak Hour

All Classes (Lights, Articulated Trucks and Single-Unit Trucks, Buses, Pedestrians, Bicycles on Crosswalk)

All Movements

ID: 745291, Location: 25.734831, -80.260385, Site Code: SR 976 Bird Road and Salzedo Street



Provided by: Apcte  
10305 NW 41st Street, Suite 115,  
Doral, FL, 33178, US

Leg Direction	SR 976/Bird Road Westbound					Salzedo Street Northbound					SR 976/Bird Road Eastbound					
Time	T	L	U	App	Ped*	R	L	U	App	Ped*	R	T	U	App	Ped*	Int
2020-01-28 4:45PM	439	0	0	<b>439</b>	1	6	3	0	<b>9</b>	4	13	286	0	<b>299</b>	0	<b>747</b>
5:00PM	447	1	0	<b>448</b>	0	8	9	0	<b>17</b>	0	9	267	0	<b>276</b>	1	<b>741</b>
5:15PM	447	0	0	<b>447</b>	0	9	7	0	<b>16</b>	8	13	289	0	<b>302</b>	0	<b>765</b>
5:30PM	403	0	0	<b>403</b>	0	11	5	0	<b>16</b>	5	15	288	1	<b>304</b>	0	<b>723</b>
<b>Total</b>	1736	1	0	<b>1737</b>	1	34	24	0	<b>58</b>	17	50	1130	1	<b>1181</b>	1	<b>2976</b>
<b>% Approach</b>	99.9%	0.1%	0%	-	-	58.6%	41.4%	0%	-	-	4.2%	95.7%	0.1%	-	-	-
<b>% Total</b>	58.3%	0%	0%	<b>58.4%</b>	-	1.1%	0.8%	0%	<b>1.9%</b>	-	1.7%	38.0%	0%	<b>39.7%</b>	-	-
<b>PHF</b>	0.971	0.250	-	<b>0.969</b>	-	0.773	0.667	-	<b>0.853</b>	-	0.833	0.978	0.250	<b>0.971</b>	-	0.973
<b>Lights</b>	1713	1	0	<b>1714</b>	-	34	23	0	<b>57</b>	-	50	1118	1	<b>1169</b>	-	2940
<b>% Lights</b>	98.7%	100%	0%	<b>98.7%</b>	-	100%	95.8%	0%	<b>98.3%</b>	-	100%	98.9%	100%	<b>99.0%</b>	-	98.8%
<b>Articulated Trucks and Single-Unit Trucks</b>	14	0	0	<b>14</b>	-	0	1	0	<b>1</b>	-	0	5	0	<b>5</b>	-	20
<b>% Articulated Trucks and Single-Unit Trucks</b>	0.8%	0%	0%	<b>0.8%</b>	-	0%	4.2%	0%	<b>1.7%</b>	-	0%	0.4%	0%	<b>0.4%</b>	-	0.7%
<b>Buses</b>	9	0	0	<b>9</b>	-	0	0	0	<b>0</b>	-	0	7	0	<b>7</b>	-	16
<b>% Buses</b>	0.5%	0%	0%	<b>0.5%</b>	-	0%	0%	0%	<b>0%</b>	-	0%	0.6%	0%	<b>0.6%</b>	-	0.5%
Pedestrians	-	-	-	-	1	-	-	-	-	16	-	-	-	-	0	-
<b>% Pedestrians</b>	-	-	-	-	100%	-	-	-	-	94.1%	-	-	-	-	0%	-
Bicycles on Crosswalk	-	-	-	-	0	-	-	-	-	1	-	-	-	-	1	-
<b>% Bicycles on Crosswalk</b>	-	-	-	-	0%	-	-	-	-	5.9%	-	-	-	-	100%	-

\*Pedestrians and Bicycles on Crosswalk. L: Left, R: Right, T: Thru, U: U-Turn

**SR976 Bird Road and Salzedo Street - TMC**

Tue Jan 28, 2020

PM Peak (4:45 PM - 5:45 PM) - Overall Peak Hour

All Classes (Lights, Articulated Trucks and Single-Unit Trucks, Buses, Pedestrians, Bicycles on Crosswalk)

All Movements

ID: 745291, Location: 25.734831, -80.260385, Site Code: SR 976 Bird Road and Salzedo Street



Provided by: Apcte  
10305 NW 41st Street, Suite 115,  
Doral, FL, 33178, US

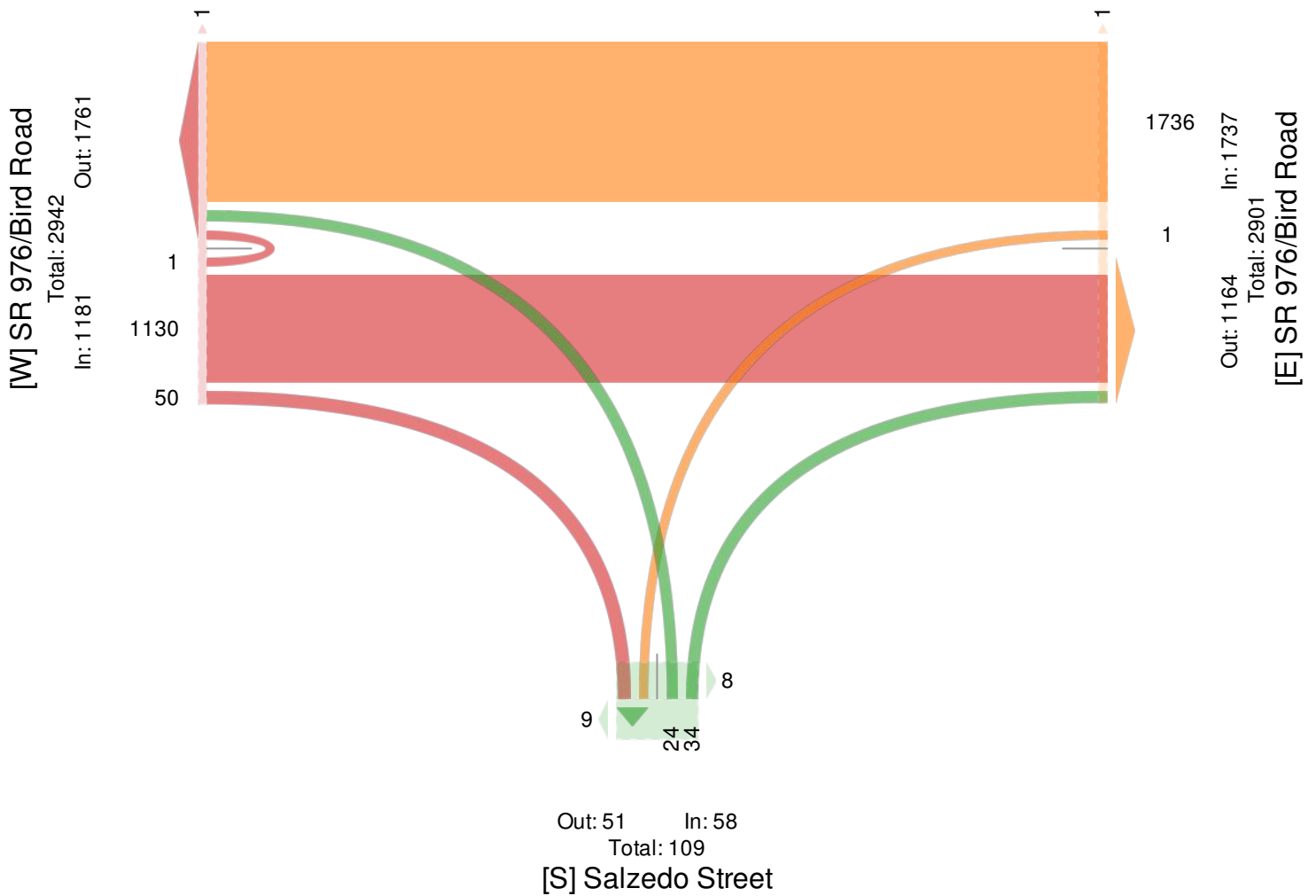

**SR976 Bird Road and Aurora Street - TMC**

Tue Jan 28, 2020

Full Length (7 AM-9 AM, 4 PM-6 PM)

All Classes (Lights, Articulated Trucks and Single-Unit Trucks, Buses, Pedestrians, Bicycles on Crosswalk)

All Movements

ID: 745290, Location: 25.734879, -80.259494, Site Code: SR 976 Bird Road and Aurora Street



Provided by: Apcte  
10305 NW 41st Street, Suite 115,  
Doral, FL, 33178, US

Leg Direction	SR 976/Bird Road Westbound					Aurora Street Northbound					SR 976/Bird Road Eastbound					Int
	T	L	U	App	Ped*	R	L	U	App	Ped*	R	T	U	App	Ped*	
2020-01-28 7:00AM	262	0	0	262	0	10	0	0	10	19	6	314	0	320	0	592
7:15AM	256	0	0	256	1	12	0	0	12	5	4	302	0	306	0	574
7:30AM	268	0	0	268	0	2	0	0	2	8	5	338	0	343	0	613
7:45AM	245	0	0	245	0	6	0	0	6	7	13	361	0	374	0	625
Hourly Total	1031	0	0	1031	1	30	0	0	30	39	28	1315	0	1343	0	2404
8:00AM	280	0	0	280	0	9	0	0	9	4	11	350	0	361	0	650
8:15AM	276	0	0	276	0	5	0	0	5	3	12	380	0	392	0	673
8:30AM	327	0	0	327	0	8	0	0	8	1	7	370	0	377	0	712
8:45AM	285	0	0	285	0	13	0	0	13	1	24	365	0	389	0	687
Hourly Total	1168	0	0	1168	0	35	0	0	35	9	54	1465	0	1519	0	2722
4:00PM	403	0	0	403	0	16	0	0	16	10	10	275	0	285	0	704
4:15PM	390	0	0	390	0	18	0	0	18	7	6	298	0	304	0	712
4:30PM	405	0	0	405	0	13	0	0	13	2	4	267	0	271	0	689
4:45PM	438	0	0	438	0	15	0	0	15	2	9	284	0	293	0	746
Hourly Total	1636	0	0	1636	0	62	0	0	62	21	29	1124	0	1153	0	2851
5:00PM	449	0	0	449	0	21	0	0	21	4	10	270	0	280	0	750
5:15PM	446	0	0	446	0	24	0	0	24	4	6	293	0	299	0	769
5:30PM	395	0	0	395	0	22	0	0	22	4	4	299	0	303	0	720
5:45PM	344	0	0	344	0	22	0	0	22	0	11	281	0	292	0	658
Hourly Total	1634	0	0	1634	0	89	0	0	89	12	31	1143	0	1174	0	2897
<b>Total</b>	5469	0	0	5469	1	216	0	0	216	81	142	5047	0	5189	0	10874
<b>% Approach</b>	100%	0%	0%	-	-	100%	0%	0%	-	-	2.7%	97.3%	0%	-	-	-
<b>% Total</b>	50.3%	0%	0%	50.3%	-	2.0%	0%	0%	2.0%	-	1.3%	46.4%	0%	47.7%	-	-
<b>Lights</b>	5355	0	0	5355	-	208	0	0	208	-	138	4943	0	5081	-	10644
<b>% Lights</b>	97.9%	0%	0%	97.9%	-	96.3%	0%	0%	96.3%	-	97.2%	97.9%	0%	97.9%	-	97.9%
<b>Articulated Trucks and Single-Unit Trucks</b>	74	0	0	74	-	8	0	0	8	-	4	66	0	70	-	152
<b>% Articulated Trucks and Single-Unit Trucks</b>	1.4%	0%	0%	1.4%	-	3.7%	0%	0%	3.7%	-	2.8%	1.3%	0%	1.3%	-	1.4%
<b>Buses</b>	40	0	0	40	-	0	0	0	0	-	0	38	0	38	-	78
<b>% Buses</b>	0.7%	0%	0%	0.7%	-	0%	0%	0%	0%	-	0%	0.8%	0%	0.7%	-	0.7%
<b>Pedestrians</b>	-	-	-	-	1	-	-	-	-	69	-	-	-	-	0	-
<b>% Pedestrians</b>	-	-	-	-	100%	-	-	-	-	85.2%	-	-	-	-	-	-
<b>Bicycles on Crosswalk</b>	-	-	-	-	0	-	-	-	-	12	-	-	-	-	0	-
<b>% Bicycles on Crosswalk</b>	-	-	-	-	0%	-	-	-	-	14.8%	-	-	-	-	-	-

\* Pedestrians and Bicycles on Crosswalk. L: Left, R: Right, T: Thru, U: U-Turn

**SR976 Bird Road and Aurora Street - TMC**

Tue Jan 28, 2020

Full Length (7 AM-9 AM, 4 PM-6 PM)

All Classes (Lights, Articulated Trucks and Single-Unit Trucks, Buses, Pedestrians, Bicycles on Crosswalk)

All Movements

ID: 745290, Location: 25.734879, -80.259494, Site Code: SR 976 Bird Road and Aurora Street



Provided by: Apcte  
10305 NW 41st Street, Suite 115,  
Doral, FL, 33178, US

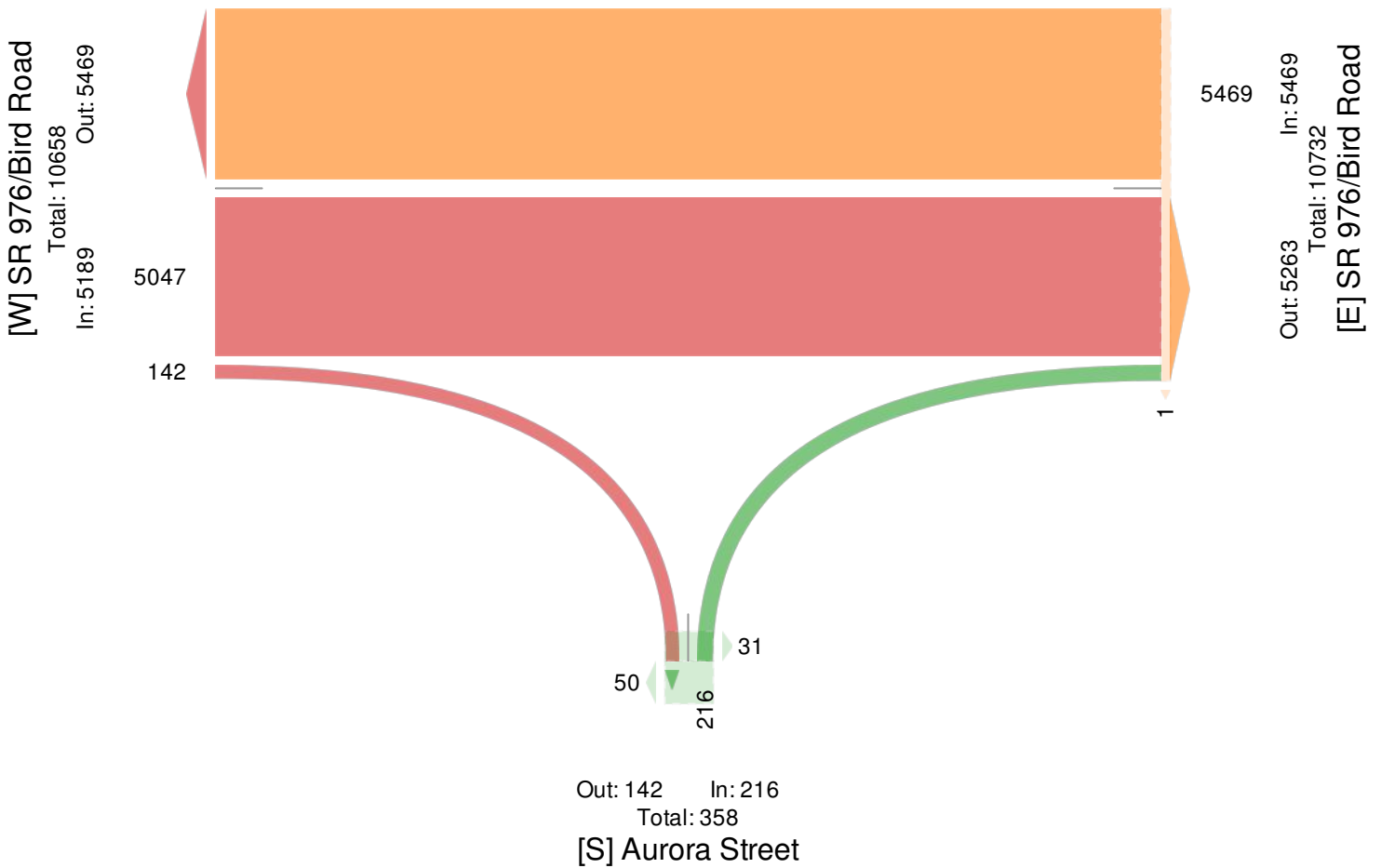



**SR976 Bird Road and Aurora Street - TMC**

Tue Jan 28, 2020

AM Peak (8 AM - 9 AM)

All Classes (Lights, Articulated Trucks and Single-Unit Trucks, Buses, Pedestrians, Bicycles on Crosswalk)

All Movements

ID: 745290, Location: 25.734879, -80.259494, Site Code: SR 976 Bird Road and Aurora Street



Provided by: Apcte  
10305 NW 41st Street, Suite 115,  
Doral, FL, 33178, US

Leg Direction	SR 976/Bird Road Westbound					Aurora Street Northbound					SR 976/Bird Road Eastbound					
Time	T	L	U	App	Ped*	R	L	U	App	Ped*	R	T	U	App	Ped*	Int
2020-01-28 8:00AM	280	0	0	280	0	9	0	0	9	4	11	350	0	361	0	650
8:15AM	276	0	0	276	0	5	0	0	5	3	12	380	0	392	0	673
8:30AM	327	0	0	327	0	8	0	0	8	1	7	370	0	377	0	712
8:45AM	285	0	0	285	0	13	0	0	13	1	24	365	0	389	0	687
<b>Total</b>	1168	0	0	1168	0	35	0	0	35	9	54	1465	0	1519	0	2722
<b>% Approach</b>	100%	0%	0%	-	-	100%	0%	0%	-	-	3.6%	96.4%	0%	-	-	-
<b>% Total</b>	42.9%	0%	0%	42.9%	-	1.3%	0%	0%	1.3%	-	2.0%	53.8%	0%	55.8%	-	-
<b>PHF</b>	0.893	-	-	0.893	-	0.673	-	-	0.673	-	0.563	0.964	-	0.969	-	0.956
<b>Lights</b>	1132	0	0	1132	-	34	0	0	34	-	53	1432	0	1485	-	2651
<b>% Lights</b>	96.9%	0%	0%	96.9%	-	97.1%	0%	0%	97.1%	-	98.1%	97.7%	0%	97.8%	-	97.4%
<b>Articulated Trucks and Single-Unit Trucks</b>	24	0	0	24	-	1	0	0	1	-	1	26	0	27	-	52
<b>% Articulated Trucks and Single-Unit Trucks</b>	2.1%	0%	0%	2.1%	-	2.9%	0%	0%	2.9%	-	1.9%	1.8%	0%	1.8%	-	1.9%
<b>Buses</b>	12	0	0	12	-	0	0	0	0	-	0	7	0	7	-	19
<b>% Buses</b>	1.0%	0%	0%	1.0%	-	0%	0%	0%	0%	-	0%	0.5%	0%	0.5%	-	0.7%
Pedestrians	-	-	-	-	0	-	-	-	-	7	-	-	-	-	0	-
% Pedestrians	-	-	-	-	-	-	-	-	-	77.8%	-	-	-	-	-	-
Bicycles on Crosswalk	-	-	-	-	0	-	-	-	-	2	-	-	-	-	0	-
% Bicycles on Crosswalk	-	-	-	-	-	-	-	-	-	22.2%	-	-	-	-	-	-

\*Pedestrians and Bicycles on Crosswalk. L: Left, R: Right, T: Thru, U: U-Turn

**SR976 Bird Road and Aurora Street - TMC**

Tue Jan 28, 2020

AM Peak (8 AM - 9 AM)

All Classes (Lights, Articulated Trucks and Single-Unit Trucks, Buses, Pedestrians, Bicycles on Crosswalk)

All Movements

ID: 745290, Location: 25.734879, -80.259494, Site Code: SR 976 Bird Road and Aurora Street



Provided by: Apcte  
10305 NW 41st Street, Suite 115,  
Doral, FL, 33178, US

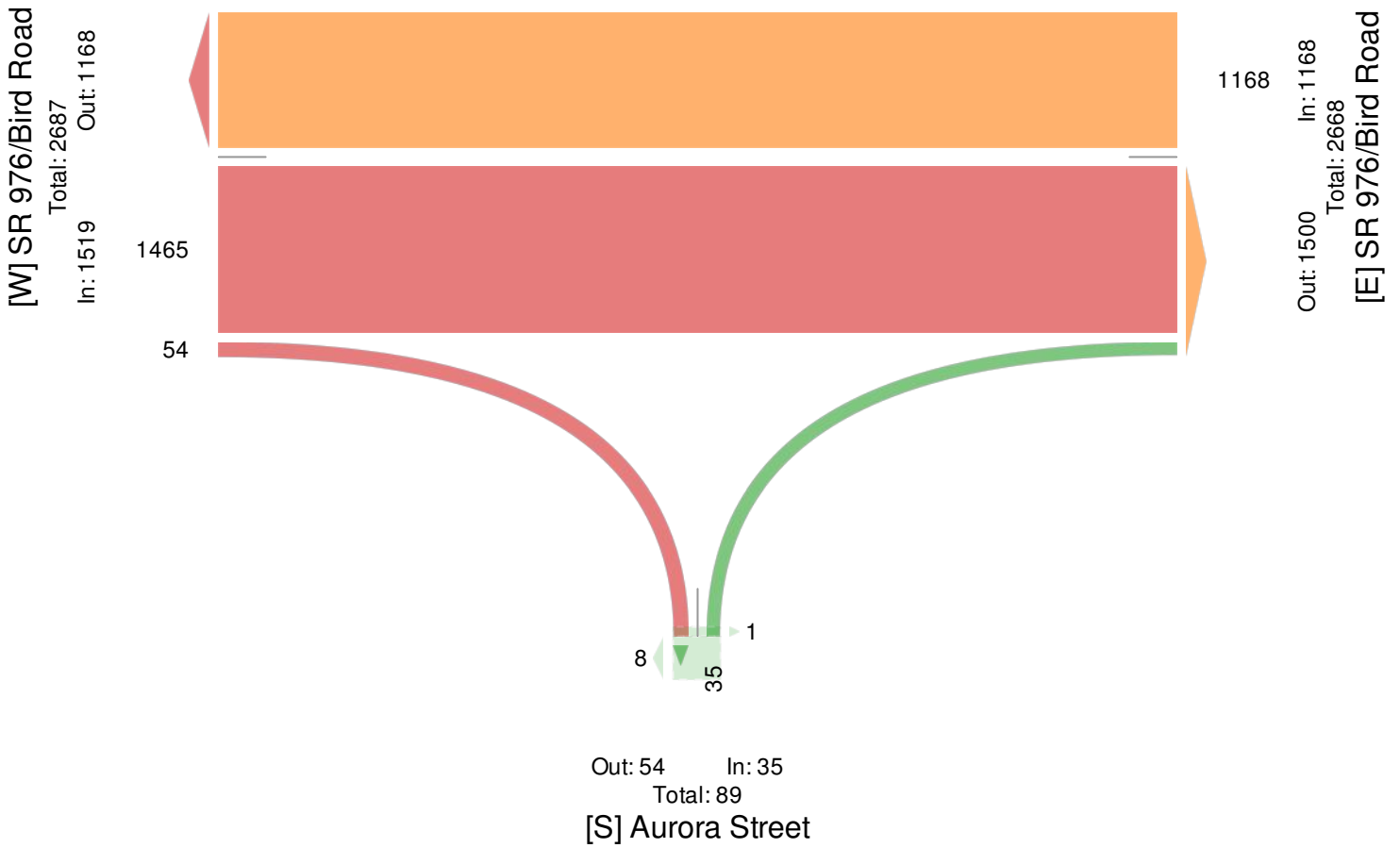

**SR976 Bird Road and Aurora Street - TMC**

Tue Jan 28, 2020

PM Peak (4:45 PM - 5:45 PM) - Overall Peak Hour

All Classes (Lights, Articulated Trucks and Single-Unit Trucks, Buses, Pedestrians, Bicycles on Crosswalk)

All Movements

ID: 745290, Location: 25.734879, -80.259494, Site Code: SR 976 Bird Road and Aurora Street



Provided by: Apcte  
10305 NW 41st Street, Suite 115,  
Doral, FL, 33178, US

Leg Direction	SR 976/Bird Road Westbound					Aurora Street Northbound					SR 976/Bird Road Eastbound					
Time	T	L	U	App	Ped*	R	L	U	App	Ped*	R	T	U	App	Ped*	Int
2020-01-28 4:45PM	438	0	0	438	0	15	0	0	15	2	9	284	0	293	0	746
5:00PM	449	0	0	449	0	21	0	0	21	4	10	270	0	280	0	750
5:15PM	446	0	0	446	0	24	0	0	24	4	6	293	0	299	0	769
5:30PM	395	0	0	395	0	22	0	0	22	4	4	299	0	303	0	720
<b>Total</b>	1728	0	0	1728	0	82	0	0	82	14	29	1146	0	1175	0	2985
<b>% Approach</b>	100%	0%	0%	-	-	100%	0%	0%	-	-	2.5%	97.5%	0%	-	-	-
<b>% Total</b>	57.9%	0%	0%	57.9%	-	2.7%	0%	0%	2.7%	-	1.0%	38.4%	0%	39.4%	-	-
<b>PHF</b>	0.962	-	-	0.962	-	0.854	-	-	0.854	-	0.725	0.958	-	0.969	-	0.970
<b>Lights</b>	1704	0	0	1704	-	78	0	0	78	-	28	1136	0	1164	-	2946
<b>% Lights</b>	98.6%	0%	0%	98.6%	-	95.1%	0%	0%	95.1%	-	96.6%	99.1%	0%	99.1%	-	98.7%
<b>Articulated Trucks and Single-Unit Trucks</b>	14	0	0	14	-	4	0	0	4	-	1	3	0	4	-	22
<b>% Articulated Trucks and Single-Unit Trucks</b>	0.8%	0%	0%	0.8%	-	4.9%	0%	0%	4.9%	-	3.4%	0.3%	0%	0.3%	-	0.7%
<b>Buses</b>	10	0	0	10	-	0	0	0	0	-	0	7	0	7	-	17
<b>% Buses</b>	0.6%	0%	0%	0.6%	-	0%	0%	0%	0%	-	0%	0.6%	0%	0.6%	-	0.6%
Pedestrians	-	-	-	-	0	-	-	-	-	10	-	-	-	-	0	-
<b>% Pedestrians</b>	-	-	-	-	-	-	-	-	-	71.4%	-	-	-	-	-	-
Bicycles on Crosswalk	-	-	-	-	0	-	-	-	-	4	-	-	-	-	0	-
<b>% Bicycles on Crosswalk</b>	-	-	-	-	-	-	-	-	-	28.6%	-	-	-	-	-	-

\*Pedestrians and Bicycles on Crosswalk. L: Left, R: Right, T: Thru, U: U-Turn

**SR976 Bird Road and Aurora Street - TMC**

Tue Jan 28, 2020

PM Peak (4:45 PM - 5:45 PM) - Overall Peak Hour

All Classes (Lights, Articulated Trucks and Single-Unit Trucks, Buses, Pedestrians, Bicycles on Crosswalk)

All Movements

ID: 745290, Location: 25.734879, -80.259494, Site Code: SR 976 Bird Road and Aurora Street



Provided by: Apcte  
10305 NW 41st Street, Suite 115,  
Doral, FL, 33178, US

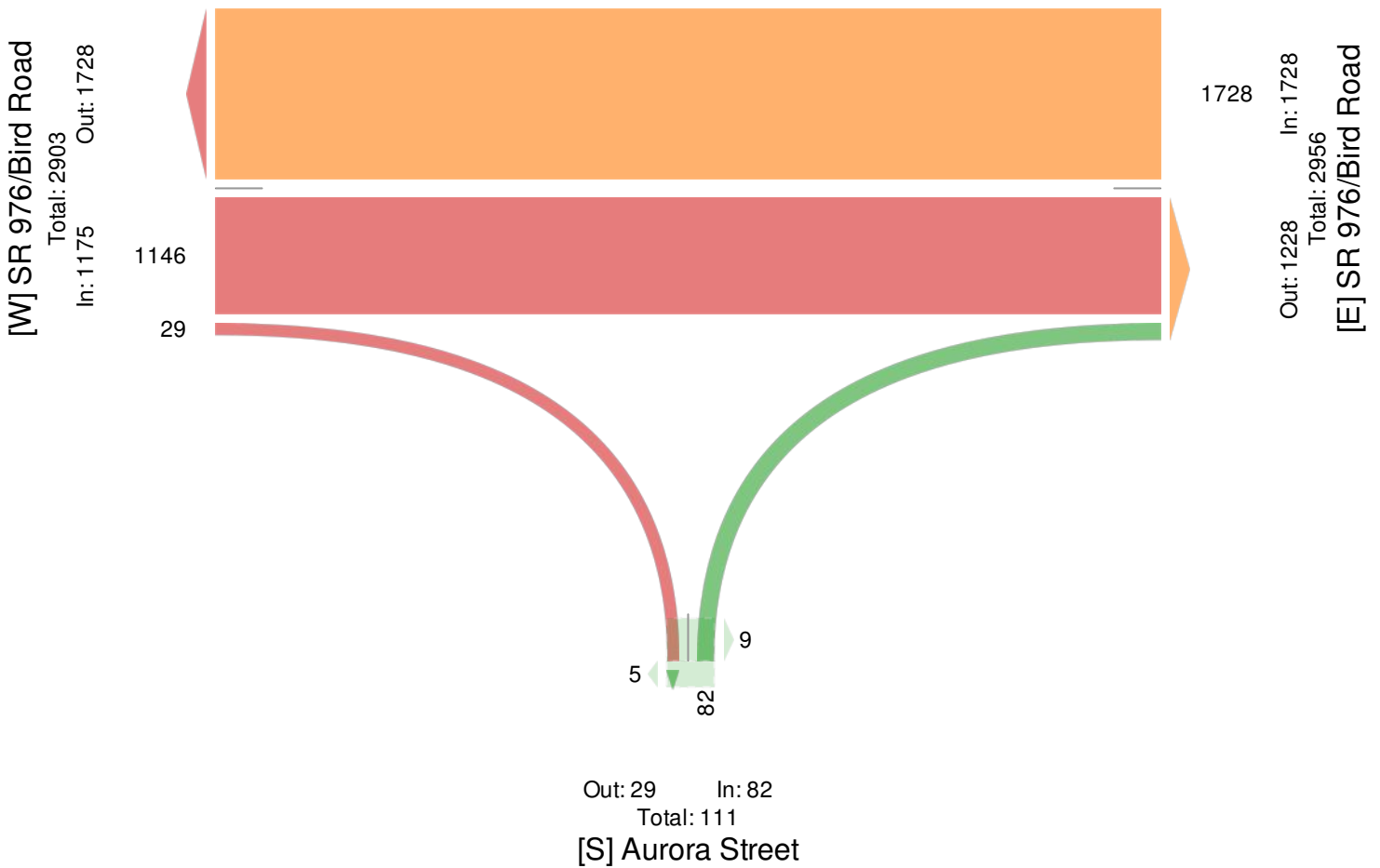

**SR 953LeJeune Road and SR976Bird Road - TMC**

Tue Jan 28, 2020

Full Length (7 AM-9 AM, 4 PM-6 PM)

All Classes (Lights, Articulated Trucks and Single-Unit Trucks, Buses, Pedestrians, Bicycles on Crosswalk)

All Movements

ID: 745289, Location: 25.734796, -80.262124, Site Code: SR 953LeJeune Road and SR 976Bird Road



Provided by: Apcte

10305 NW 41st Street, Suite 115, Doral, FL, 33178, US

Leg Direction	SR 953LeJeune Road Southbound						SR 976/Bird Road Westbound						SR 953LeJeune Road Northbound						SR 976/Bird Road Eastbound						Int
	R	T	L	U	App	Ped*	R	T	L	U	App	Ped*	R	T	L	U	App	Ped*	R	T	L	U	App	Ped*	
2020-01-28 7:00AM	12	137	28	1	178	24	53	167	17	9	246	27	13	104	18	0	135	42	40	207	28	10	285	79	844
7:15AM	17	139	32	0	188	7	37	186	14	7	244	11	19	123	19	0	161	29	41	236	30	3	310	49	903
7:30AM	13	128	42	0	183	3	24	206	11	6	247	3	8	113	20	0	141	8	35	297	32	0	364	4	935
7:45AM	15	159	36	0	210	0	26	209	23	7	265	2	10	157	12	0	179	8	44	344	34	2	424	2	1078
Hourly Total	57	563	138	1	759	34	140	768	65	29	1002	43	50	497	69	0	616	87	160	1084	124	15	1383	134	3760
8:00AM	16	168	33	0	217	1	31	220	9	2	262	4	8	170	26	0	204	6	44	304	48	1	397	2	1080
8:15AM	8	188	30	0	226	2	34	204	21	4	263	0	9	186	23	1	219	3	47	346	35	0	428	3	1136
8:30AM	19	165	36	0	220	2	34	261	20	3	318	1	9	167	25	0	201	3	31	323	45	1	400	3	1139
8:45AM	8	172	37	0	217	2	36	203	22	0	261	4	12	200	30	0	242	3	39	337	43	1	420	0	1140
Hourly Total	51	693	136	0	880	7	135	888	72	9	1104	9	38	723	104	1	866	15	161	1310	171	3	1645	8	4495
4:00PM	23	165	31	0	219	1	39	348	25	5	417	4	9	216	36	0	261	10	32	239	28	1	300	1	1197
4:15PM	16	154	22	0	192	3	46	333	15	2	396	2	10	229	47	0	286	8	31	259	26	0	316	4	1190
4:30PM	16	170	33	0	219	0	38	356	24	2	420	1	14	186	26	0	226	4	32	237	23	1	293	0	1158
4:45PM	15	176	33	0	224	0	40	374	24	3	441	2	20	151	37	0	208	3	36	252	27	0	315	0	1188
Hourly Total	70	665	119	0	854	4	163	1411	88	12	1674	9	53	782	146	0	981	25	131	987	104	2	1224	5	4733
5:00PM	19	201	31	0	251	1	36	352	32	7	427	0	25	172	26	0	223	0	48	205	23	0	276	0	1177
5:15PM	9	228	32	0	269	0	48	378	32	2	460	3	20	199	26	0	245	6	36	245	27	0	308	4	1282
5:30PM	25	196	37	0	258	0	55	313	29	4	401	1	10	194	32	0	236	9	43	256	29	0	328	0	1223
5:45PM	9	249	19	0	277	2	42	247	28	6	323	0	16	164	25	0	205	2	38	240	29	0	307	1	1112
Hourly Total	62	874	119	0	1055	3	181	1290	121	19	1611	4	71	729	109	0	909	17	165	946	108	0	1219	5	4794
<b>Total</b>	240	2795	512	1	3548	48	619	4357	346	69	5391	65	212	2731	428	1	3372	144	617	4327	507	20	5471	152	17782
<b>% Approach</b>	6.8%	78.8%	14.4%	0%	-	-	11.5%	80.8%	6.4%	1.3%	-	-	6.3%	81.0%	12.7%	0%	-	-	11.3%	79.1%	9.3%	0.4%	-	-	-
<b>% Total</b>	1.3%	15.7%	2.9%	0%	20.0%	-	3.5%	24.5%	1.9%	0.4%	30.3%	-	1.2%	15.4%	2.4%	0%	19.0%	-	3.5%	24.3%	2.9%	0.1%	30.8%	-	-
<b>Lights</b>	238	2743	495	1	3477	-	596	4274	343	69	5282	-	208	2682	417	1	3308	-	608	4230	490	20	5348	-	17415
<b>% Lights</b>	99.2%	98.1%	96.7%	100%	98.0%	-	96.3%	98.1%	99.1%	100%	98.0%	-	98.1%	98.2%	97.4%	100%	98.1%	-	98.5%	97.8%	96.6%	100%	97.8%	-	97.9%
<b>Articulated Trucks and Single-Unit Trucks</b>	2	39	8	0	49	-	8	59	1	0	68	-	3	39	4	0	46	-	6	67	8	0	81	-	244
<b>% Articulated Trucks and Single-Unit Trucks</b>	0.8%	1.4%	1.6%	0%	1.4%	-	1.3%	1.4%	0.3%	0%	1.3%	-	1.4%	1.4%	0.9%	0%	1.4%	-	1.0%	1.5%	1.6%	0%	1.5%	-	1.4%
<b>Buses</b>	0	13	9	0	22	-	15	24	2	0	41	-	1	10	7	0	18	-	3	30	9	0	42	-	123
<b>% Buses</b>	0%	0.5%	1.8%	0%	0.6%	-	2.4%	0.6%	0.6%	0%	0.8%	-	0.5%	0.4%	1.6%	0%	0.5%	-	0.5%	0.7%	1.8%	0%	0.8%	-	0.7%
<b>Pedestrians</b>	-	-	-	-	-	45	-	-	-	-	54	-	-	-	-	-	138	-	-	-	-	-	-	146	-
<b>% Pedestrians</b>	-	-	-	-	-93.8%	-	-	-	-	-	-83.1%	-	-	-	-	-	-95.8%	-	-	-	-	-	-	-96.1%	-
<b>Bicycles on Crosswalk</b>	-	-	-	-	-	3	-	-	-	-	11	-	-	-	-	-	6	-	-	-	-	-	-	6	-
<b>% Bicycles on Crosswalk</b>	-	-	-	-	-	6.3%	-	-	-	-	16.9%	-	-	-	-	-	4.2%	-	-	-	-	-	-	3.9%	-

\*Pedestrians and Bicycles on Crosswalk. L: Left, R: Right, T: Thru, U: U-Turn

**SR 953LeJeune Road and SR 976Bird Road - TMC**

Tue Jan 28, 2020

Full Length (7 AM-9 AM, 4 PM-6 PM)

All Classes (Lights, Articulated Trucks and Single-Unit Trucks, Buses, Pedestrians, Bicycles on Crosswalk)

All Movements

ID: 745289, Location: 25.734796, -80.262124, Site Code: SR 953LeJeune Road and SR 976Bird Road



Provided by: Apcte  
10305 NW 41st Street, Suite 115,  
Doral, FL, 33178, US

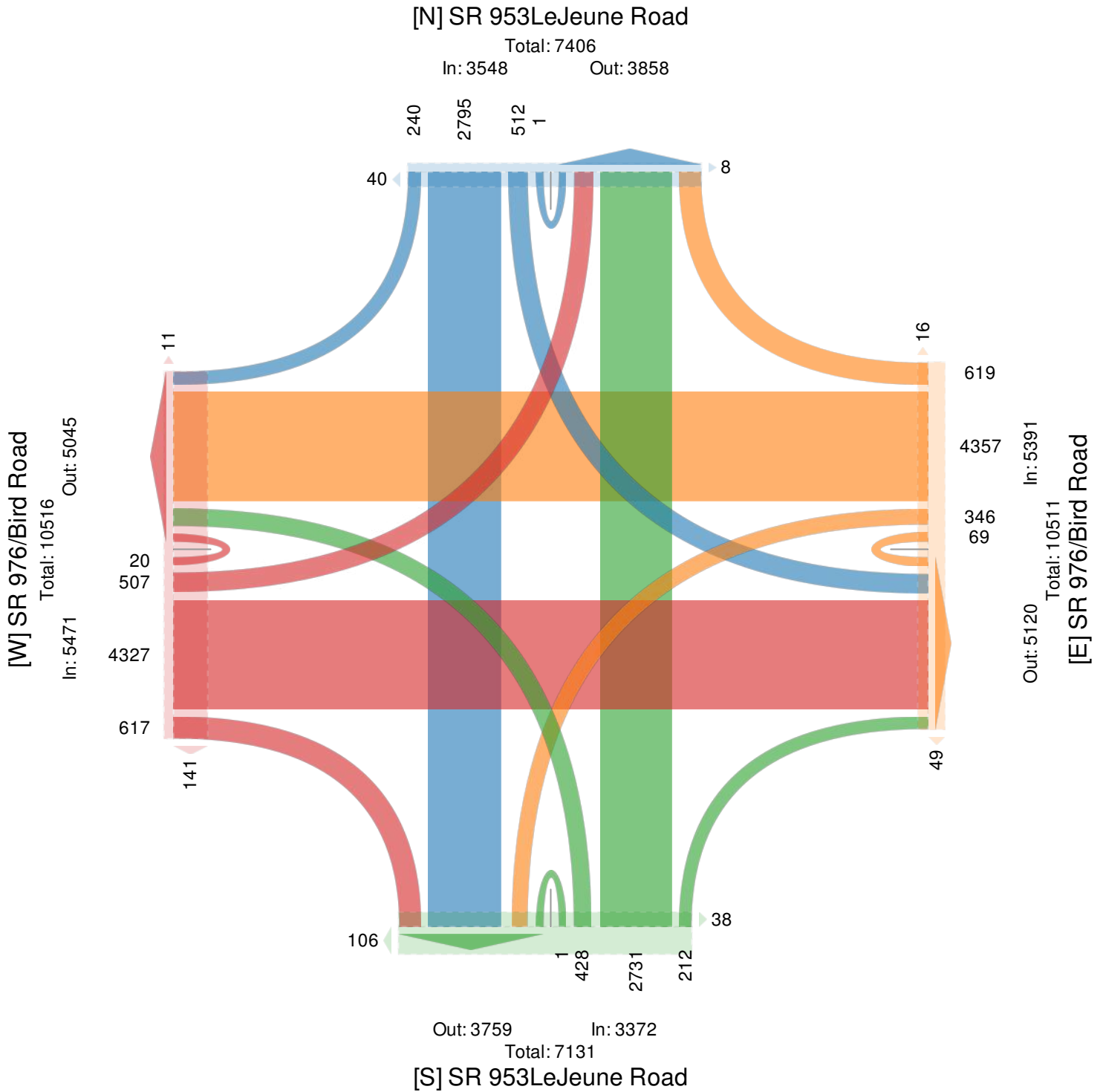

**SR 953LeJeune Road and SR 976Bird Road - TMC**

Tue Jan 28, 2020

AM Peak (8 AM - 9 AM)

All Classes (Lights, Articulated Trucks and Single-Unit Trucks, Buses, Pedestrians, Bicycles on Crosswalk)

All Movements

ID: 745289, Location: 25.734796, -80.262124, Site Code: SR 953LeJeune Road and SR 976Bird Road



Provided by: Apcte

10305 NW 41st Street, Suite 115, Doral, FL, 33178, US

Leg Direction	SR 953LeJeune Road Southbound						SR 976/Bird Road Westbound						SR 953LeJeune Road Northbound						SR 976/Bird Road Eastbound						Int
	R	T	L	U	App	Ped*	R	T	L	U	App	Ped*	R	T	L	U	App	Ped*	R	T	L	U	App	Ped*	
2020-01-28 8:00AM	16	168	33	0	217	1	31	220	9	2	262	4	8	170	26	0	204	6	44	304	48	1	397	2	1080
8:15AM	8	188	30	0	226	2	34	204	21	4	263	0	9	186	23	1	219	3	47	346	35	0	428	3	1136
8:30AM	19	165	36	0	220	2	34	261	20	3	318	1	9	167	25	0	201	3	31	323	45	1	400	3	1139
8:45AM	8	172	37	0	217	2	36	203	22	0	261	4	12	200	30	0	242	3	39	337	43	1	420	0	1140
<b>Total</b>	51	693	136	0	880	7	135	888	72	9	1104	9	38	723	104	1	866	15	161	1310	171	3	1645	8	4495
<b>% Approach</b>	5.8%	78.8%	15.5%	0%	-	-	12.2%	80.4%	6.5%	0.8%	-	-	4.4%	83.5%	12.0%	0.1%	-	-	9.8%	79.6%	10.4%	0.2%	-	-	-
<b>% Total</b>	1.1%	15.4%	3.0%	0%	19.6%	-	3.0%	19.8%	1.6%	0.2%	24.6%	-	0.8%	16.1%	2.3%	0%	19.3%	-	3.6%	29.1%	3.8%	0.1%	36.6%	-	-
<b>PHF</b>	0.671	0.922	0.919	-	0.973	-	0.938	0.851	0.818	0.563	0.868	-	0.792	0.904	0.867	0.250	0.895	-	0.856	0.947	0.891	0.750	0.961	-	0.986
<b>Lights</b>	50	673	132	0	855	-	128	862	71	9	1070	-	37	710	96	1	844	-	158	1275	165	3	1601	-	4370
<b>% Lights</b>	98.0%	97.1%	97.1%	0%	97.2%	-	94.8%	97.1%	98.6%	100%	96.9%	-	97.4%	98.2%	92.3%	100%	97.5%	-	98.1%	97.3%	96.5%	100%	97.3%	-	97.2%
<b>Articulated Trucks and Single-Unit Trucks</b>	1	18	2	0	21	-	3	17	0	0	20	-	1	10	1	0	12	-	2	28	4	0	34	-	87
<b>% Articulated Trucks and Single-Unit Trucks</b>	2.0%	2.6%	1.5%	0%	2.4%	-	2.2%	1.9%	0%	0%	1.8%	-	2.6%	1.4%	1.0%	0%	1.4%	-	1.2%	2.1%	2.3%	0%	2.1%	-	1.9%
<b>Buses</b>	0	2	2	0	4	-	4	9	1	0	14	-	0	3	7	0	10	-	1	7	2	0	10	-	38
<b>% Buses</b>	0%	0.3%	1.5%	0%	0.5%	-	3.0%	1.0%	1.4%	0%	1.3%	-	0%	0.4%	6.7%	0%	1.2%	-	0.6%	0.5%	1.2%	0%	0.6%	-	0.8%
Pedestrians	-	-	-	-	-	6	-	-	-	-	-	5	-	-	-	-	-	11	-	-	-	-	-	6	-
<b>% Pedestrians</b>	-	-	-	-	-	85.7%	-	-	-	-	-	55.6%	-	-	-	-	-	73.3%	-	-	-	-	-	75.0%	-
Bicycles on Crosswalk	-	-	-	-	-	1	-	-	-	-	-	4	-	-	-	-	-	4	-	-	-	-	-	2	-
<b>% Bicycles on Crosswalk</b>	-	-	-	-	-	14.3%	-	-	-	-	-	44.4%	-	-	-	-	-	26.7%	-	-	-	-	-	25.0%	-

\*Pedestrians and Bicycles on Crosswalk. L: Left, R: Right, T: Thru, U: U-Turn

**SR 953LeJeune Road and SR 976Bird Road - TMC**

Tue Jan 28, 2020

AM Peak (8 AM - 9 AM)

All Classes (Lights, Articulated Trucks and Single-Unit Trucks, Buses, Pedestrians, Bicycles on Crosswalk)

All Movements

ID: 745289, Location: 25.734796, -80.262124, Site Code: SR 953LeJeune Road and SR 976Bird Road



Provided by: Apcte  
10305 NW 41st Street, Suite 115,  
Doral, FL, 33178, US

**[N] SR 953LeJeune Road**

Total: 1909

In: 880 Out: 1029

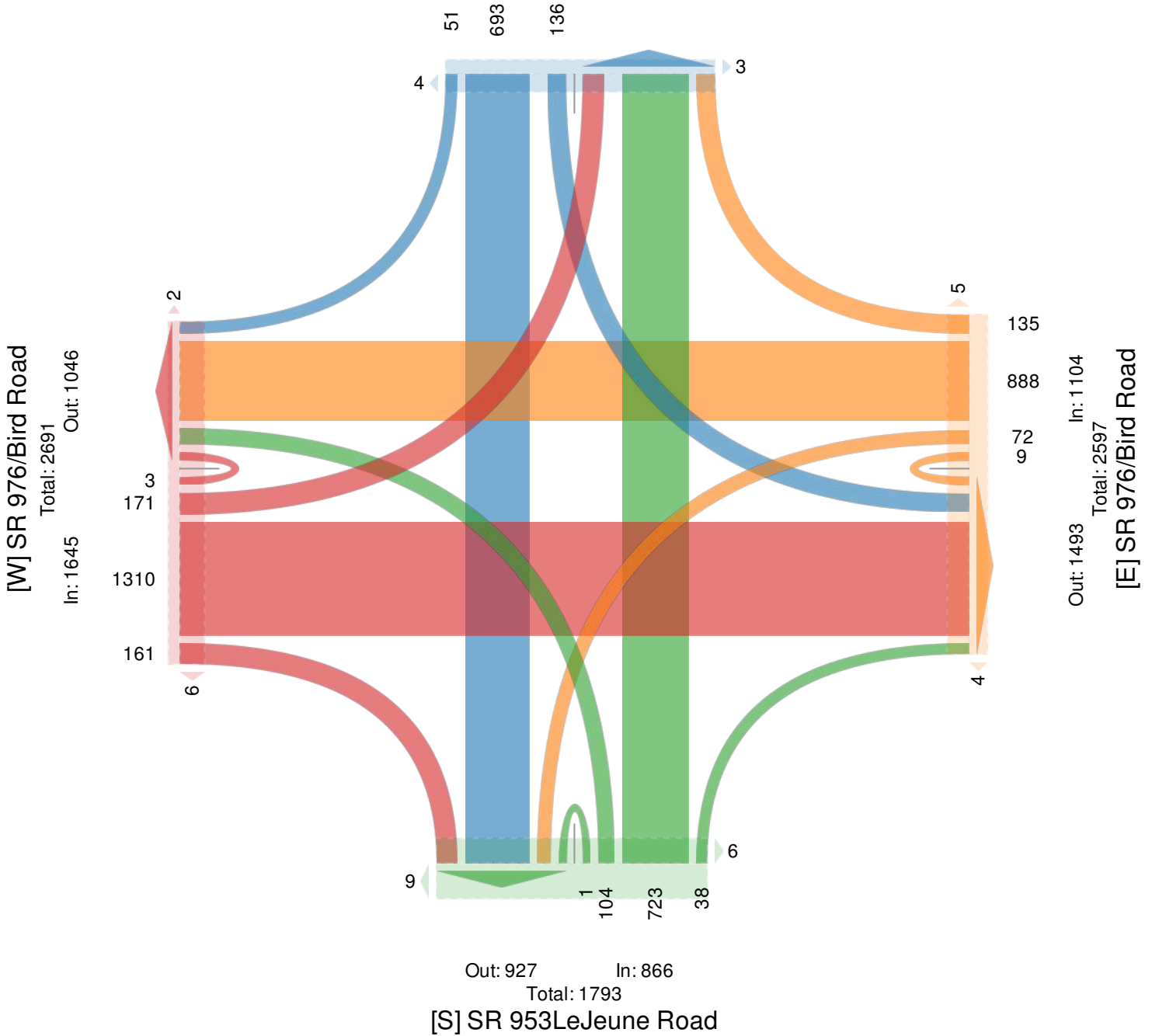



**SR 953LeJeune Road and SR 976Bird Road - TMC**

Tue Jan 28, 2020

PM Peak (4:45 PM - 5:45 PM) - Overall Peak Hour

All Classes (Lights, Articulated Trucks and Single-Unit Trucks, Buses, Pedestrians, Bicycles on Crosswalk)

All Movements

ID: 745289, Location: 25.734796, -80.262124, Site Code: SR 953LeJeune Road and SR 976Bird Road



Provided by: Apcte  
10305 NW 41st Street, Suite 115,  
Doral, FL, 33178, US

Leg Direction	SR 953LeJeune Road Southbound						SR 976/Bird Road Westbound						SR 953LeJeune Road Northbound						SR 976/Bird Road Eastbound						Int
	R	T	L	U	App	Ped*	R	T	L	U	App	Ped*	R	T	L	U	App	Ped*	R	T	L	U	App	Ped*	
2020-01-28 4:45PM	15	176	33	0	224	0	40	374	24	3	441	2	20	151	37	0	208	3	36	252	27	0	315	0	1188
5:00PM	19	201	31	0	251	1	36	352	32	7	427	0	25	172	26	0	223	0	48	205	23	0	276	0	1177
5:15PM	9	228	32	0	269	0	48	378	32	2	460	3	20	199	26	0	245	6	36	245	27	0	308	4	1282
5:30PM	25	196	37	0	258	0	55	313	29	4	401	1	10	194	32	0	236	9	43	256	29	0	328	0	1223
<b>Total</b>	68	801	133	0	1002	1	179	1417	117	16	1729	6	75	716	121	0	912	18	163	958	106	0	1227	4	4870
<b>% Approach</b>	6.8%	79.9%	13.3%	0%	-	-	10.4%	82.0%	6.8%	0.9%	-	-	8.2%	78.5%	13.3%	0%	-	-	13.3%	78.1%	8.6%	0%	-	-	-
<b>% Total</b>	1.4%	16.4%	2.7%	0%	20.6%	-	3.7%	29.1%	2.4%	0.3%	35.5%	-	1.5%	14.7%	2.5%	0%	18.7%	-	3.3%	19.7%	2.2%	0%	25.2%	-	-
<b>PHF</b>	0.680	0.878	0.899	-	0.931	-	0.814	0.937	0.914	0.571	0.940	-	0.750	0.899	0.818	-	0.931	-	0.849	0.936	0.914	-	0.935	-	0.950
<b>Lights</b>	68	799	130	0	997	-	175	1398	117	16	1706	-	75	703	120	0	898	-	162	949	105	0	1216	-	4817
<b>% Lights</b>	100%	99.8%	97.7%	0%	99.5%	-	97.8%	98.7%	100%	100%	98.7%	-	100%	98.2%	99.2%	0%	98.5%	-	99.4%	99.1%	99.1%	0%	99.1%	-	98.9%
<b>Articulated Trucks and Single-Unit Trucks</b>	0	1	1	0	2	-	2	13	0	0	15	-	0	10	1	0	11	-	0	4	1	0	5	-	33
<b>% Articulated Trucks and Single-Unit Trucks</b>	0%	0.1%	0.8%	0%	0.2%	-	1.1%	0.9%	0%	0%	0.9%	-	0%	1.4%	0.8%	0%	1.2%	-	0%	0.4%	0.9%	0%	0.4%	-	0.7%
<b>Buses</b>	0	1	2	0	3	-	2	6	0	0	8	-	0	3	0	0	3	-	1	5	0	0	6	-	20
<b>% Buses</b>	0%	0.1%	1.5%	0%	0.3%	-	1.1%	0.4%	0%	0%	0.5%	-	0%	0.4%	0%	0%	0.3%	-	0.6%	0.5%	0%	0%	0.5%	-	0.4%
Pedestrians	-	-	-	-	-	1	-	-	-	-	-	5	-	-	-	-	-	16	-	-	-	-	-	4	-
<b>% Pedestrians</b>	-	-	-	-	-	100%	-	-	-	-	-	83.3%	-	-	-	-	-	88.9%	-	-	-	-	-	100%	-
Bicycles on Crosswalk	-	-	-	-	-	0	-	-	-	-	-	1	-	-	-	-	-	2	-	-	-	-	-	0	-
<b>% Bicycles on Crosswalk</b>	-	-	-	-	-	0%	-	-	-	-	-	16.7%	-	-	-	-	-	11.1%	-	-	-	-	-	0%	-

\*Pedestrians and Bicycles on Crosswalk. L: Left, R: Right, T: Thru, U: U-Turn

**SR 953 LeJeune Road and SR 976 Bird Road - TMC**

Tue Jan 28, 2020

PM Peak (4:45 PM - 5:45 PM) - Overall Peak Hour

All Classes (Lights, Articulated Trucks and Single-Unit Trucks, Buses, Pedestrians, Bicycles on Crosswalk)

All Movements

ID: 745289, Location: 25.734796, -80.262124, Site Code: SR 953 LeJeune Road and SR 976 Bird Road



Provided by: Apcte  
10305 NW 41st Street, Suite 115,  
Doral, FL, 33178, US

**[N] SR 953 LeJeune Road**

Total: 2003

In: 1002 Out: 1001

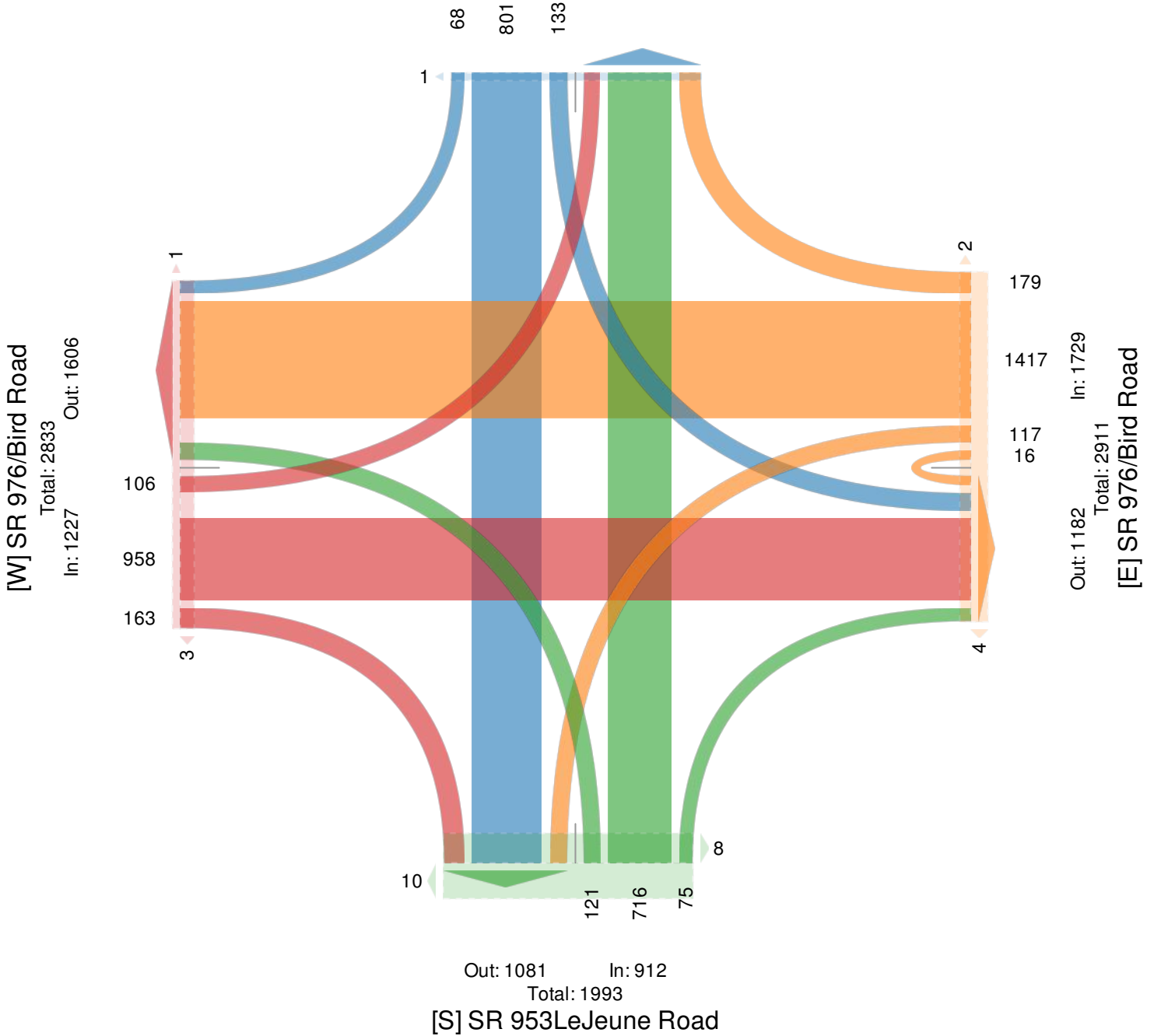

**SR 953LeJeune Road and Altara Avenue - TMC**

Tue Jan 28, 2020

Full Length (7 AM-9 AM, 4 PM-6 PM)

All Classes (Lights, Articulated Trucks and Single-Unit Trucks, Buses, Pedestrians, Bicycles on Crosswalk)

All Movements

ID: 745288, Location: 25.733114, -80.262008, Site Code: SR 953LeJeune Road and Altara Avenue



Provided by: Apcte  
10305 NW 41st Street, Suite 115,  
Doral, FL, 33178, US

Leg Direction	SR 953LeJeune Road Southbound						Altara Avenue Westbound						SR 953LeJeune Road Northbound						West Eastbound						Int
	R	T	L	U	App	Ped*	R	T	L	U	App	Ped*	R	T	L	U	App	Ped*	R	T	L	U	App	Ped*	
2020-01-28 7:00AM	0	189	13	1	203	0	49	0	22	0	71	4	29	113	0	0	142	298	0	0	0	0	0	355	416
7:15AM	0	199	16	0	215	0	28	0	15	0	43	4	9	131	0	0	140	141	0	0	0	0	0	122	398
7:30AM	0	179	7	0	186	0	11	0	10	0	21	4	8	146	0	0	154	5	0	0	0	0	0	10	361
7:45AM	0	228	14	1	243	0	3	0	7	0	10	0	10	173	0	0	183	6	0	0	0	0	0	7	436
Hourly Total	0	795	50	2	847	0	91	0	54	0	145	12	56	563	0	0	619	450	0	0	0	0	0	494	1611
8:00AM	0	218	12	1	231	0	12	0	12	0	24	1	14	193	0	0	207	0	0	0	0	0	0	0	462
8:15AM	0	260	11	0	271	0	6	0	9	0	15	0	13	219	0	0	232	1	0	0	0	0	0	5	518
8:30AM	0	197	13	0	210	0	14	0	15	0	29	4	12	190	0	0	202	3	0	0	0	0	0	5	441
8:45AM	0	218	14	0	232	0	11	0	9	0	20	0	14	242	0	0	256	1	0	0	0	0	0	29	508
Hourly Total	0	893	50	1	944	0	43	0	45	0	88	5	53	844	0	0	897	5	0	0	0	0	0	39	1929
4:00PM	0	201	21	0	222	1	24	0	20	0	44	3	9	250	0	0	259	25	0	0	0	0	0	7	525
4:15PM	0	190	13	0	203	0	15	0	18	0	33	0	13	253	0	1	267	16	0	0	0	0	0	13	503
4:30PM	0	217	12	0	229	0	18	0	27	0	45	0	16	214	0	0	230	19	0	0	0	0	0	6	504
4:45PM	0	212	24	0	236	0	14	0	30	0	44	1	13	181	0	0	194	6	0	0	0	0	0	15	474
Hourly Total	0	820	70	0	890	1	71	0	95	0	166	4	51	898	0	1	950	66	0	0	0	0	0	41	2006
5:00PM	0	264	19	0	283	0	23	0	26	0	49	0	13	204	0	0	217	7	0	0	0	0	0	20	549
5:15PM	0	279	17	0	296	0	24	0	25	0	49	0	13	227	0	0	240	22	0	0	0	0	0	17	585
5:30PM	0	246	19	0	265	0	24	0	24	0	48	2	16	195	0	0	211	14	0	0	0	0	0	10	524
5:45PM	0	294	15	0	309	0	19	0	29	0	48	1	18	198	0	0	216	16	0	0	0	0	0	12	573
Hourly Total	0	1083	70	0	1153	0	90	0	104	0	194	3	60	824	0	0	884	59	0	0	0	0	0	59	2231
<b>Total</b>	0	3591	240	3	3834	1	295	0	298	0	593	24	220	3129	0	1	3350	580	0	0	0	0	0	633	7777
<b>% Approach</b>	0%	93.7%	6.3%	0.1%	-	-	49.7%	0%	50.3%	0%	-	-	6.6%	93.4%	0%	0%	-	-	0%	0%	0%	0%	-	-	-
<b>% Total</b>	0%	46.2%	3.1%	0%	49.3%	-	3.8%	0%	3.8%	0%	7.6%	-	2.8%	40.2%	0%	0%	43.1%	-	0%	0%	0%	0%	0%	-	-
<b>Lights</b>	0	3528	239	3	3770	-	293	0	296	0	589	-	219	3069	0	1	3289	-	0	0	0	0	0	-	7648
<b>% Lights</b>	0%	98.2%	99.6%	100%	98.3%	-	99.3%	0%	99.3%	0%	99.3%	-	99.5%	98.1%	0%	100%	98.2%	-	0%	0%	0%	0%	-	-	98.3%
<b>Articulated Trucks and Single-Unit Trucks</b>	0	35	0	0	35	-	2	0	1	0	3	-	1	37	0	0	38	-	0	0	0	0	0	-	76
<b>% Articulated Trucks and Single-Unit Trucks</b>	0%	1.0%	0%	0%	0.9%	-	0.7%	0%	0.3%	0%	0.5%	-	0.5%	1.2%	0%	0%	1.1%	-	0%	0%	0%	0%	-	-	1.0%
<b>Buses</b>	0	28	1	0	29	-	0	0	1	0	1	-	0	23	0	0	23	-	0	0	0	0	0	-	53
<b>% Buses</b>	0%	0.8%	0.4%	0%	0.8%	-	0%	0%	0.3%	0%	0.2%	-	0%	0.7%	0%	0%	0.7%	-	0%	0%	0%	0%	-	-	0.7%
<b>Pedestrians</b>	-	-	-	-	-	1	-	-	-	-	-	19	-	-	-	-	-	577	-	-	-	-	-	629	
<b>% Pedestrians</b>	-	-	-	-	-	100%	-	-	-	-	-	79.2%	-	-	-	-	-	99.5%	-	-	-	-	-	99.4%	-
<b>Bicycles on Crosswalk</b>	-	-	-	-	-	0	-	-	-	-	-	5	-	-	-	-	-	3	-	-	-	-	-	4	
<b>% Bicycles on Crosswalk</b>	-	-	-	-	-	0%	-	-	-	-	-	20.8%	-	-	-	-	-	0.5%	-	-	-	-	-	0.6%	-

\*Pedestrians and Bicycles on Crosswalk. L: Left, R: Right, T: Thru, U: U-Turn

**SR 953 LeJeune Road and Altara Avenue - TMC**

Tue Jan 28, 2020

Full Length (7 AM-9 AM, 4 PM-6 PM)

All Classes (Lights, Articulated Trucks and Single-Unit Trucks, Buses, Pedestrians, Bicycles on Crosswalk)

All Movements

ID: 745288, Location: 25.733114, -80.262008, Site Code: SR 953 LeJeune Road and Altara Avenue



Provided by: Apcte  
10305 NW 41st Street, Suite 115,  
Doral, FL, 33178, US

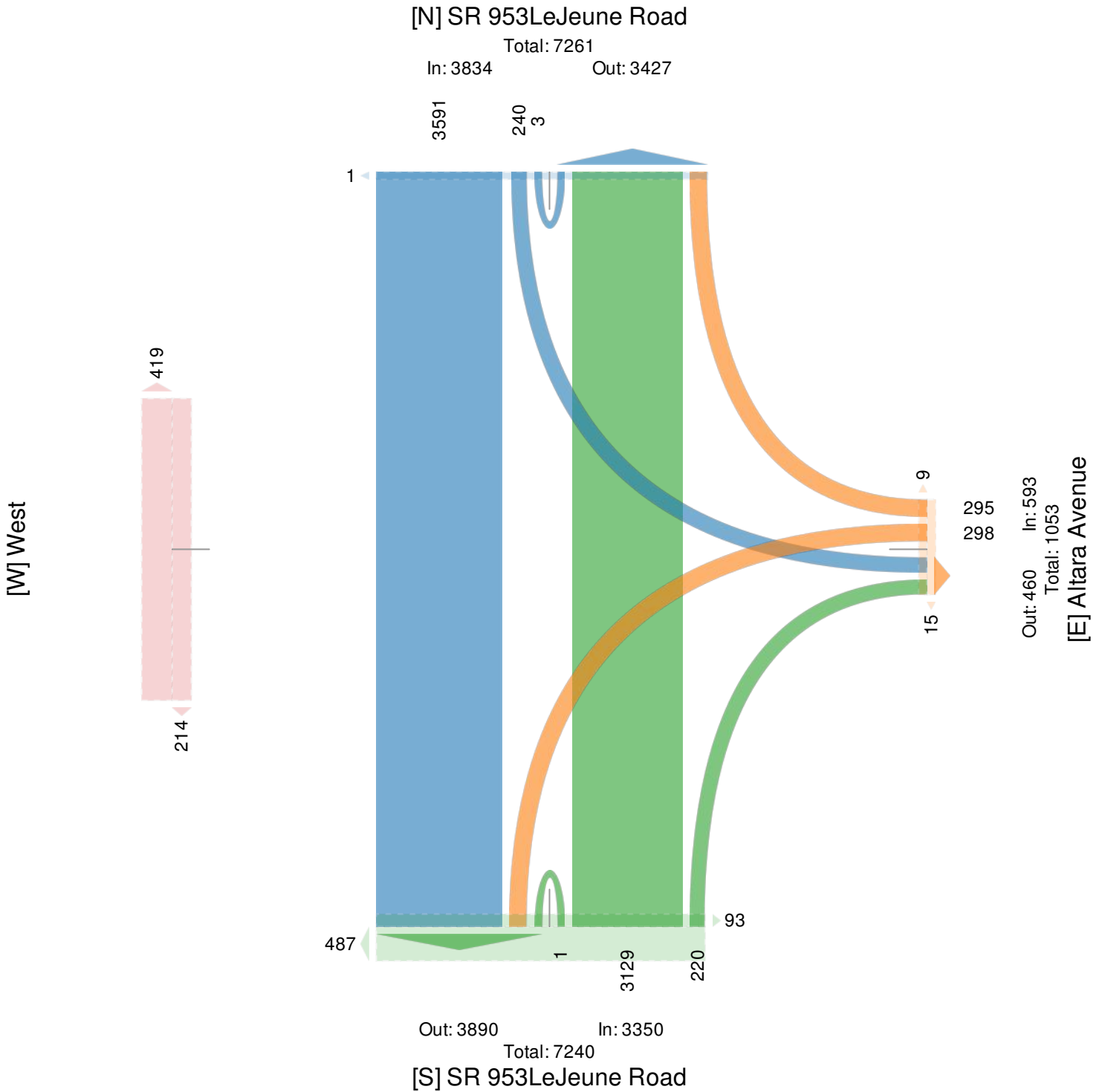

**SR 953LeJeune Road and Altara Avenue - TMC**

Tue Jan 28, 2020

AM Peak (8 AM - 9 AM)

All Classes (Lights, Articulated Trucks and Single-Unit Trucks, Buses, Pedestrians, Bicycles on Crosswalk)

All Movements

ID: 745288, Location: 25.733114, -80.262008, Site Code: SR 953LeJeune Road and Altara Avenue



Provided by: Apcte  
10305 NW 41st Street, Suite 115,  
Doral, FL, 33178, US

Leg Direction	SR 953LeJeune Road Southbound						Altara Avenue Westbound						SR 953LeJeune Road Northbound						West Eastbound						
Time	R	T	L	U	App	Ped*	R	T	L	U	App	Ped*	R	T	L	U	App	Ped*	R	T	L	U	App	Ped*	Int
2020-01-28 8:00AM	0	218	12	1	231	0	12	0	12	0	24	1	14	193	0	0	207	0	0	0	0	0	0	0	462
8:15AM	0	260	11	0	271	0	6	0	9	0	15	0	13	219	0	0	232	1	0	0	0	0	0	0	518
8:30AM	0	197	13	0	210	0	14	0	15	0	29	4	12	190	0	0	202	3	0	0	0	0	0	0	441
8:45AM	0	218	14	0	232	0	11	0	9	0	20	0	14	242	0	0	256	1	0	0	0	0	0	0	508
<b>Total</b>	0	893	50	1	944	0	43	0	45	0	88	5	53	844	0	0	897	5	0	0	0	0	0	0	1929
<b>% Approach</b>	0%	94.6%	5.3%	0.1%	-	-	48.9%	0%	51.1%	0%	-	-	5.9%	94.1%	0%	0%	-	-	0%	0%	0%	0%	-	-	-
<b>% Total</b>	0%	46.3%	2.6%	0.1%	48.9%	-	2.2%	0%	2.3%	0%	4.6%	-	2.7%	43.8%	0%	0%	46.5%	-	0%	0%	0%	0%	0%	-	-
<b>PHF</b>	-	0.859	0.893	0.250	0.871	-	0.768	-	0.750	-	0.759	-	0.946	0.872	-	-	0.876	-	-	-	-	-	-	-	0.931
<b>Lights</b>	0	871	50	1	922	-	42	0	44	0	86	-	52	822	0	0	874	-	0	0	0	0	0	-	1882
<b>% Lights</b>	0%	97.5%	100%	100%	97.7%	-	97.7%	0%	97.8%	0%	97.7%	-	98.1%	97.4%	0%	0%	97.4%	-	0%	0%	0%	0%	-	-	97.6%
<b>Articulated Trucks and Single-Unit Trucks</b>	0	16	0	0	16	-	1	0	1	0	2	-	1	12	0	0	13	-	0	0	0	0	0	-	31
<b>% Articulated Trucks and Single-Unit Trucks</b>	0%	1.8%	0%	0%	1.7%	-	2.3%	0%	2.2%	0%	2.3%	-	1.9%	1.4%	0%	0%	1.4%	-	0%	0%	0%	0%	-	-	1.6%
<b>Buses</b>	0	6	0	0	6	-	0	0	0	0	0	-	0	10	0	0	10	-	0	0	0	0	0	-	16
<b>% Buses</b>	0%	0.7%	0%	0%	0.6%	-	0%	0%	0%	0%	0%	-	0%	1.2%	0%	0%	1.1%	-	0%	0%	0%	0%	-	-	0.8%
Pedestrians	-	-	-	-	-	0	-	-	-	-	-	4	-	-	-	-	-	4	-	-	-	-	-	38	-
<b>% Pedestrians</b>	-	-	-	-	-	-	-	-	-	-	-80.0%	-	-	-	-	-	-80.0%	-	-	-	-	-	-	-97.4%	-
Bicycles on Crosswalk	-	-	-	-	-	0	-	-	-	-	-	1	-	-	-	-	-	1	-	-	-	-	-	1	-
<b>% Bicycles on Crosswalk</b>	-	-	-	-	-	-	-	-	-	-	-20.0%	-	-	-	-	-	-20.0%	-	-	-	-	-	-	-2.6%	-

\*Pedestrians and Bicycles on Crosswalk. L: Left, R: Right, T: Thru, U: U-Turn

**SR 953LeJeune Road and Altara Avenue - TMC**

Tue Jan 28, 2020

AM Peak (8 AM - 9 AM)

All Classes (Lights, Articulated Trucks and Single-Unit Trucks, Buses, Pedestrians, Bicycles on Crosswalk)

All Movements

ID: 745288, Location: 25.733114, -80.262008, Site Code: SR 953LeJeune Road and Altara Avenue



Provided by: Apcte  
10305 NW 41st Street, Suite 115,  
Doral, FL, 33178, US

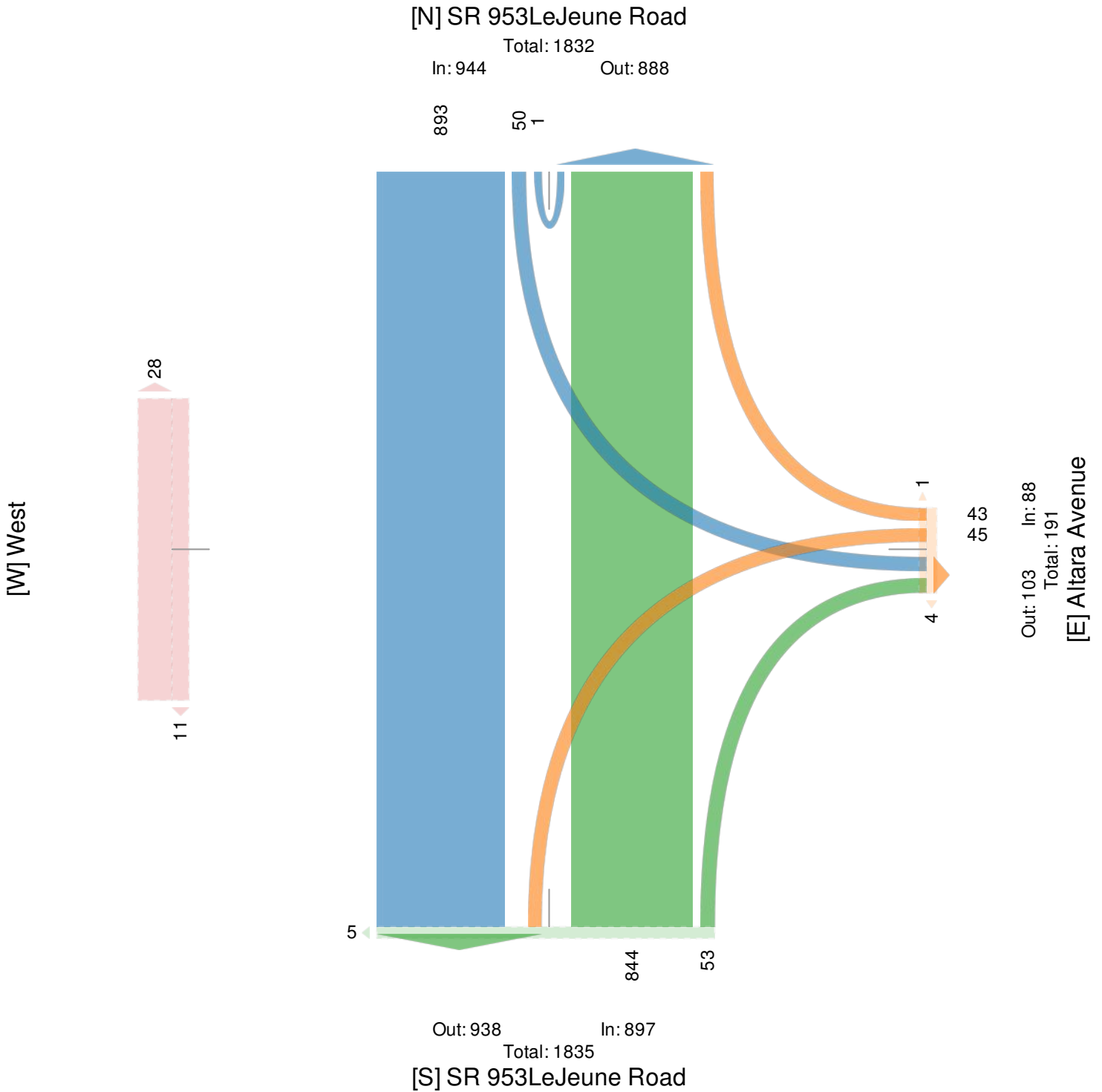

**SR 953LeJeune Road and Altara Avenue - TMC**

Tue Jan 28, 2020

PM Peak (5 PM - 6 PM) - Overall Peak Hour

All Classes (Lights, Articulated Trucks and Single-Unit Trucks, Buses, Pedestrians, Bicycles on Crosswalk)

All Movements

ID: 745288, Location: 25.733114, -80.262008, Site Code: SR 953LeJeune Road and Altara Avenue



Provided by: Apcte  
10305 NW 41st Street, Suite 115,  
Doral, FL, 33178, US

Leg Direction	SR 953LeJeune Road Southbound						Altara Avenue Westbound						SR 953LeJeune Road Northbound						West Eastbound						Int
	R	T	L	U	App	Ped*	R	T	L	U	App	Ped*	R	T	L	U	App	Ped*	R	T	L	U	App	Ped*	
2020-01-28 5:00PM	0	264	19	0	283	0	23	0	26	0	49	0	13	204	0	0	217	7	0	0	0	0	0	20	549
5:15PM	0	279	17	0	296	0	24	0	25	0	49	0	13	227	0	0	240	22	0	0	0	0	0	17	585
5:30PM	0	246	19	0	265	0	24	0	24	0	48	2	16	195	0	0	211	14	0	0	0	0	0	10	524
5:45PM	0	294	15	0	309	0	19	0	29	0	48	1	18	198	0	0	216	16	0	0	0	0	0	12	573
<b>Total</b>	0	1083	70	0	1153	0	90	0	104	0	194	3	60	824	0	0	884	59	0	0	0	0	0	59	2231
<b>% Approach</b>	0%	93.9%	6.1%	0%	-	-	46.4%	0%	53.6%	0%	-	-	6.8%	93.2%	0%	0%	-	-	0%	0%	0%	0%	-	-	-
<b>% Total</b>	0%	48.5%	3.1%	0%	51.7%	-	4.0%	0%	4.7%	0%	8.7%	-	2.7%	36.9%	0%	0%	39.6%	-	0%	0%	0%	0%	0%	-	-
<b>PHF</b>	-	0.921	0.921	-	0.933	-	0.938	-	0.897	-	0.990	-	0.833	0.907	-	-	0.921	-	-	-	-	-	-	-	0.953
<b>Lights</b>	0	1077	70	0	1147	-	89	0	104	0	193	-	60	817	0	0	877	-	0	0	0	0	0	-	2217
<b>% Lights</b>	0%	99.4%	100%	0%	99.5%	-	98.9%	0%	100%	0%	99.5%	-	100%	99.2%	0%	0%	99.2%	-	0%	0%	0%	0%	-	-	99.4%
<b>Articulated Trucks and Single-Unit Trucks</b>	0	2	0	0	2	-	1	0	0	0	1	-	0	5	0	0	5	-	0	0	0	0	0	-	8
<b>% Articulated Trucks and Single-Unit Trucks</b>	0%	0.2%	0%	0%	0.2%	-	1.1%	0%	0%	0%	0.5%	-	0%	0.6%	0%	0%	0.6%	-	0%	0%	0%	0%	-	-	0.4%
<b>Buses</b>	0	4	0	0	4	-	0	0	0	0	0	-	0	2	0	0	2	-	0	0	0	0	0	-	6
<b>% Buses</b>	0%	0.4%	0%	0%	0.3%	-	0%	0%	0%	0%	0%	-	0%	0.2%	0%	0%	0.2%	-	0%	0%	0%	0%	-	-	0.3%
<b>Pedestrians</b>	-	-	-	-	-	0	-	-	-	-	-	1	-	-	-	-	-	58	-	-	-	-	-	59	-
<b>% Pedestrians</b>	-	-	-	-	-	-	-	-	-	-	-	-33.3%	-	-	-	-	-	-98.3%	-	-	-	-	-	-100%	-
<b>Bicycles on Crosswalk</b>	-	-	-	-	-	0	-	-	-	-	-	2	-	-	-	-	-	1	-	-	-	-	-	0	-
<b>% Bicycles on Crosswalk</b>	-	-	-	-	-	-	-	-	-	-	-	-66.7%	-	-	-	-	-	-1.7%	-	-	-	-	-	0%	-

\*Pedestrians and Bicycles on Crosswalk. L: Left, R: Right, T: Thru, U: U-Turn

**SR 953LeJeune Road and Altara Avenue - TMC**

Tue Jan 28, 2020

PM Peak (5 PM - 6 PM) - Overall Peak Hour

All Classes (Lights, Articulated Trucks and Single-Unit Trucks, Buses, Pedestrians, Bicycles on Crosswalk)

All Movements

ID: 745288, Location: 25.733114, -80.262008, Site Code: SR 953LeJeune Road and Altara Avenue



Provided by: Apcte  
10305 NW 41st Street, Suite 115,  
Doral, FL, 33178, US

**[N] SR 953LeJeune Road**

Total: 2067  
In: 1153 Out: 914

1083

70

[W] West

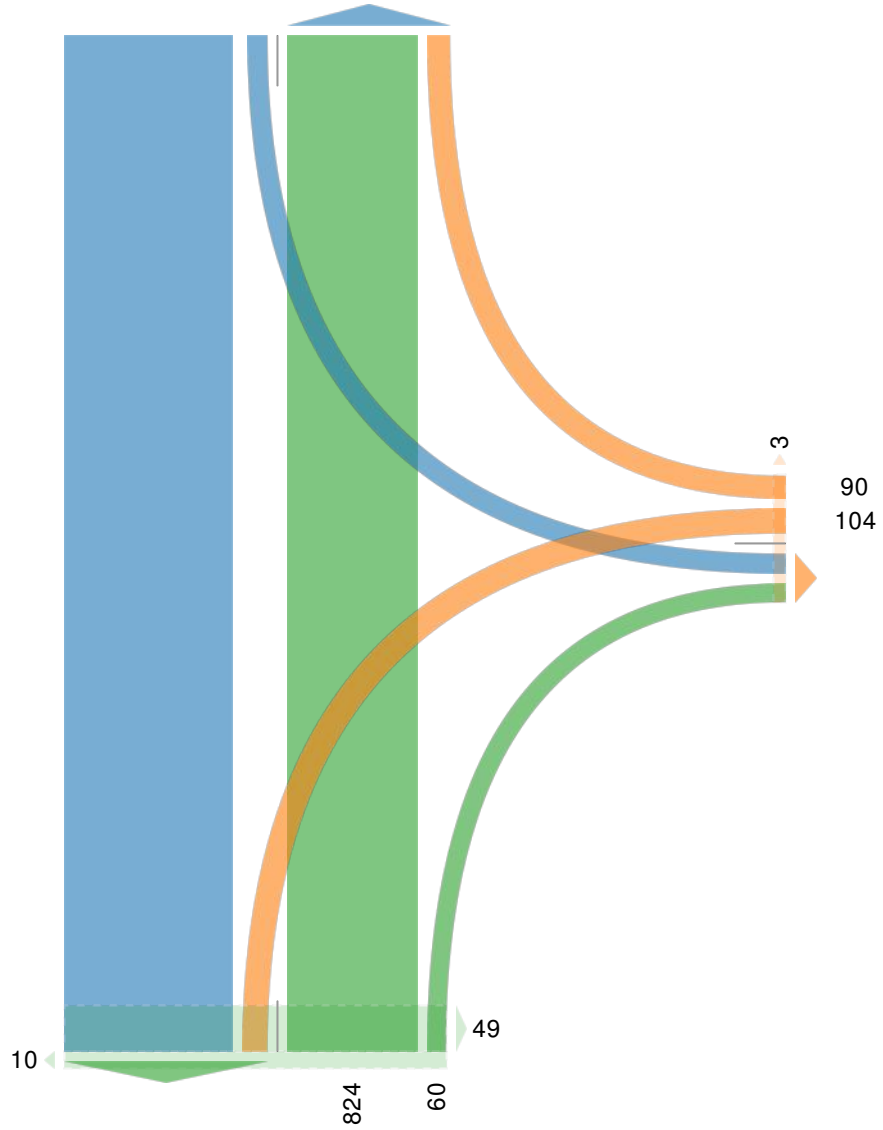
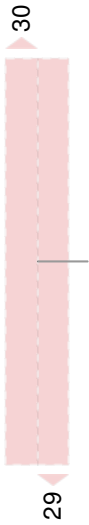

Out: 130 In: 194  
Total: 324  
[E] Altara Avenue

10

824

60

49

Out: 1187 In: 884  
Total: 2071

**[S] SR 953LeJeune Road**



**Ponce De Leon Boulevard and SR 976 Bird Road - TMC**

Tue Jan 28, 2020

Full Length (7 AM-9 AM, 4 PM-6 PM)

All Classes (Lights, Articulated Trucks and Single-Unit Trucks, Buses, Pedestrians, Bicycles on Crosswalk)

All Movements

ID: 745287, Location: 25.734923, -80.258581, Site Code: Ponce De Leon Boulevard and SR 976 Bird Road



Provided by: Apcte

10305 NW 41st Street, Suite 115, Doral, FL, 33178, US

Leg Direction	Ponce De Leon Boulevard Southbound						SR 976/Bird Road Westbound						Ponce De Leon Boulevard Northbound						SR 976/Bird Road Eastbound						Int
	R	T	L	U	App	Ped*	R	T	L	U	App	Ped*	R	T	L	U	App	Ped*	R	T	L	U	App	Ped*	
2020-01-28 7:00AM	19	110	47	0	176	4	21	237	47	0	305	3	24	73	11	0	108	16	9	255	37	1	302	4	891
7:15AM	8	113	51	0	172	3	22	217	39	0	278	3	28	72	8	0	108	3	11	257	32	0	300	2	858
7:30AM	11	63	55	0	129	0	25	241	23	0	289	0	14	58	6	0	78	7	22	265	30	0	317	4	813
7:45AM	11	84	40	0	135	0	34	240	25	0	299	2	12	70	4	0	86	3	26	308	18	1	353	0	873
Hourly Total	49	370	193	0	612	7	102	935	134	0	1171	8	78	273	29	0	380	29	68	1085	117	2	1272	10	3435
8:00AM	11	92	45	1	149	1	41	239	39	0	319	0	10	66	10	0	86	6	24	287	37	0	348	3	902
8:15AM	15	104	29	2	150	1	37	247	39	0	323	2	7	107	12	0	126	2	24	302	43	0	369	4	968
8:30AM	21	101	42	1	165	1	43	298	37	0	378	4	14	84	16	0	114	3	26	304	34	1	365	5	1022
8:45AM	10	92	39	0	141	6	55	264	41	0	360	5	14	82	11	0	107	2	37	278	47	1	363	5	971
Hourly Total	57	389	155	4	605	9	176	1048	156	0	1380	11	45	339	49	0	433	13	111	1171	161	2	1445	17	3863
4:00PM	33	71	23	3	130	0	27	338	37	0	402	0	20	103	32	0	155	5	18	240	31	1	290	5	977
4:15PM	24	67	37	3	131	1	26	350	27	0	403	1	19	74	20	0	113	9	20	271	31	0	322	3	969
4:30PM	24	78	22	2	126	1	20	369	36	0	425	3	19	93	25	0	137	2	11	241	30	0	282	3	970
4:45PM	35	72	33	5	145	3	24	382	28	0	434	2	13	72	28	0	113	4	26	244	31	0	301	4	993
Hourly Total	116	288	115	13	532	5	97	1439	128	0	1664	6	71	342	105	0	518	20	75	996	123	1	1195	15	3909
5:00PM	45	102	19	1	167	2	33	395	39	0	467	3	18	86	23	0	127	2	16	255	24	0	295	9	1056
5:15PM	26	112	31	2	171	1	32	390	27	0	449	5	17	73	28	0	118	8	20	251	34	0	305	4	1043
5:30PM	36	115	28	1	180	8	27	345	28	0	400	3	16	88	19	0	123	7	14	256	40	0	310	10	1013
5:45PM	34	95	37	2	168	5	19	293	31	0	343	5	15	81	25	0	121	0	17	253	35	0	305	0	937
Hourly Total	141	424	115	6	686	16	111	1423	125	0	1659	16	66	328	95	0	489	17	67	1015	133	0	1215	23	4049
<b>Total</b>	<b>363</b>	<b>1471</b>	<b>578</b>	<b>23</b>	<b>2435</b>	<b>37</b>	<b>486</b>	<b>4845</b>	<b>543</b>	<b>0</b>	<b>5874</b>	<b>41</b>	<b>260</b>	<b>1282</b>	<b>278</b>	<b>0</b>	<b>1820</b>	<b>79</b>	<b>321</b>	<b>4267</b>	<b>534</b>	<b>5</b>	<b>5127</b>	<b>65</b>	<b>15256</b>
<b>% Approach</b>	14.9%	60.4%	23.7%	0.9%	-	-	8.3%	82.5%	9.2%	0%	-	-	14.3%	70.4%	15.3%	0%	-	-	6.3%	83.2%	10.4%	0.1%	-	-	-
<b>% Total</b>	2.4%	9.6%	3.8%	0.2%	16.0%	-	3.2%	31.8%	3.6%	0%	38.5%	-	1.7%	8.4%	1.8%	0%	11.9%	-	2.1%	28.0%	3.5%	0%	33.6%	-	-
<b>Lights</b>	358	1432	573	23	2386	-	479	4746	537	0	5762	-	256	1250	273	0	1779	-	312	4169	524	5	5010	-	14937
<b>% Lights</b>	98.6%	97.3%	99.1%	100%	98.0%	-	98.6%	98.0%	98.9%	0%	98.1%	-	98.5%	97.5%	98.2%	0%	97.7%	-	97.2%	97.7%	98.1%	100%	97.7%	-	97.9%
<b>Articulated Trucks and Single-Unit Trucks</b>	5	15	5	0	25	-	5	61	3	0	69	-	4	6	3	0	13	-	8	64	7	0	79	-	186
<b>% Articulated Trucks and Single-Unit Trucks</b>	1.4%	1.0%	0.9%	0%	1.0%	-	1.0%	1.3%	0.6%	0%	1.2%	-	1.5%	0.5%	1.1%	0%	0.7%	-	2.5%	1.5%	1.3%	0%	1.5%	-	1.2%
<b>Buses</b>	0	24	0	0	24	-	2	38	3	0	43	-	0	26	2	0	28	-	1	34	3	0	38	-	133
<b>% Buses</b>	0%	1.6%	0%	0%	1.0%	-	0.4%	0.8%	0.6%	0%	0.7%	-	0%	2.0%	0.7%	0%	1.5%	-	0.3%	0.8%	0.6%	0%	0.7%	-	0.9%
<b>Pedestrians</b>	-	-	-	-	-	31	-	-	-	-	-	34	-	-	-	-	-	74	-	-	-	-	-	52	-
<b>% Pedestrians</b>	-	-	-	-	-	83.8%	-	-	-	-	-	82.9%	-	-	-	-	-	93.7%	-	-	-	-	-	80.0%	-
<b>Bicycles on Crosswalk</b>	-	-	-	-	-	6	-	-	-	-	-	7	-	-	-	-	-	5	-	-	-	-	-	13	-
<b>% Bicycles on Crosswalk</b>	-	-	-	-	-	16.2%	-	-	-	-	-	17.1%	-	-	-	-	-	6.3%	-	-	-	-	-	20.0%	-

\* Pedestrians and Bicycles on Crosswalk. L: Left, R: Right, T: Thru, U: U-Turn

**Ponce De Leon Boulevard and SR 976 Bird Road - TMC**

Tue Jan 28, 2020

Full Length (7 AM-9 AM, 4 PM-6 PM)

All Classes (Lights, Articulated Trucks and Single-Unit Trucks, Buses, Pedestrians, Bicycles on Crosswalk)

All Movements

ID: 745287, Location: 25.734923, -80.258581, Site Code: Ponce De Leon Boulevard and SR 976 Bird Road



Provided by: Apcte  
10305 NW 41st Street, Suite 115,  
Doral, FL, 33178, US

**[N] Ponce De Leon Boulevard**

Total: 4760

In: 2435 Out: 2325

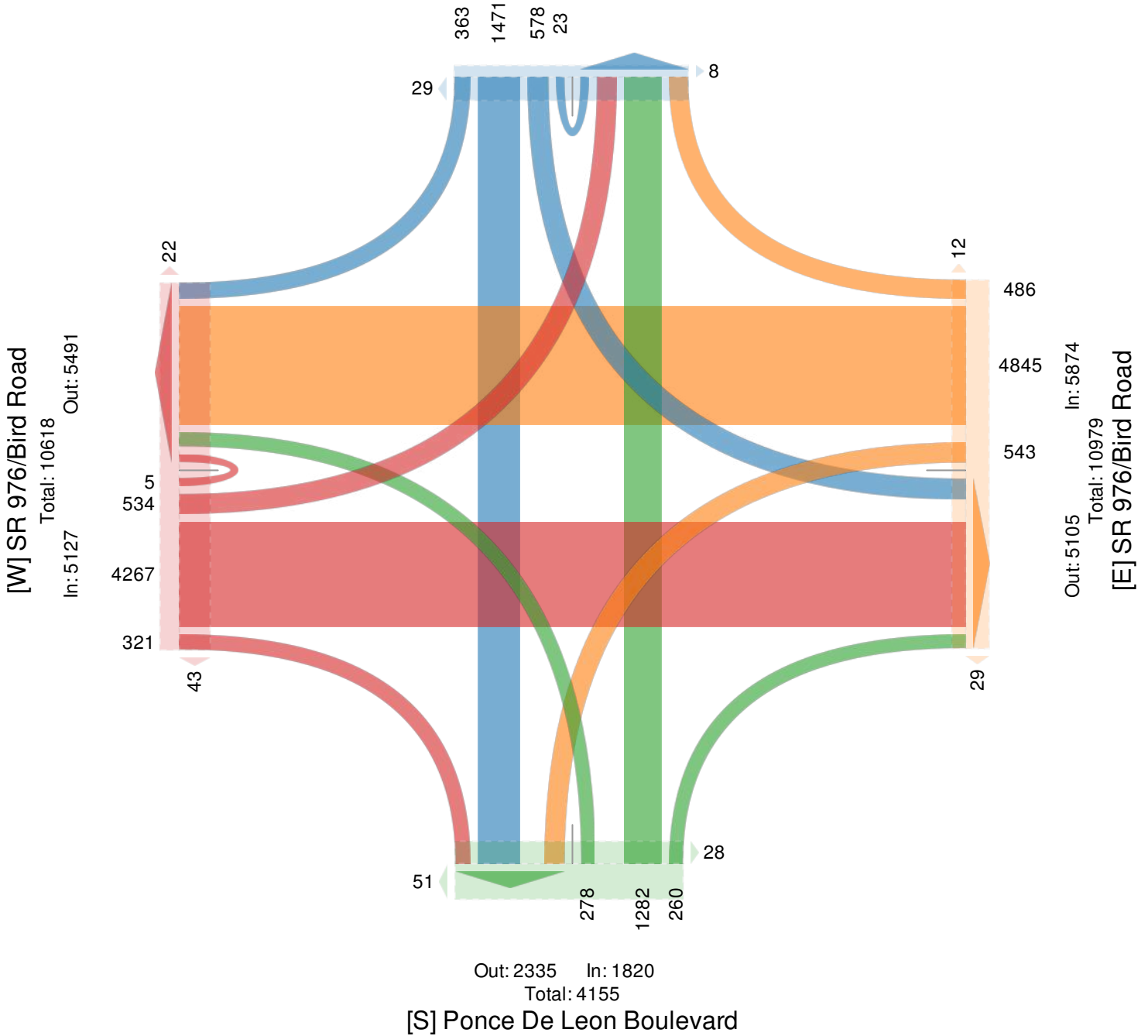

**Ponce De Leon Boulevard and SR976Bird Road - TMC**

Tue Jan 28, 2020

AM Peak (8 AM - 9 AM)

All Classes (Lights, Articulated Trucks and Single-Unit Trucks, Buses, Pedestrians, Bicycles on Crosswalk)

All Movements

ID: 745287, Location: 25.734923, -80.258581, Site Code: Ponce De Leon Boulevard and SR 976Bird Road



Provided by: Apcte

10305 NW 41st Street, Suite 115, Doral, FL, 33178, US

Leg Direction	Ponce De Leon Boulevard Southbound						SR 976/Bird Road Westbound						Ponce De Leon Boulevard Northbound						SR 976/Bird Road Eastbound						Int
	R	T	L	U	App	Ped*	R	T	L	U	App	Ped*	R	T	L	U	App	Ped*	R	T	L	U	App	Ped*	
2020-01-28 8:00AM	11	92	45	1	149	1	41	239	39	0	319	0	10	66	10	0	86	6	24	287	37	0	348	3	902
8:15AM	15	104	29	2	150	1	37	247	39	0	323	2	7	107	12	0	126	2	24	302	43	0	369	4	968
8:30AM	21	101	42	1	165	1	43	298	37	0	378	4	14	84	16	0	114	3	26	304	34	1	365	5	1022
8:45AM	10	92	39	0	141	6	55	264	41	0	360	5	14	82	11	0	107	2	37	278	47	1	363	5	971
<b>Total</b>	57	389	155	4	605	9	176	1048	156	0	1380	11	45	339	49	0	433	13	111	1171	161	2	1445	17	3863
<b>% Approach</b>	9.4%	64.3%	25.6%	0.7%	-	-	12.8%	75.9%	11.3%	0%	-	-	10.4%	78.3%	11.3%	0%	-	-	7.7%	81.0%	11.1%	0.1%	-	-	-
<b>% Total</b>	1.5%	10.1%	4.0%	0.1%	15.7%	-	4.6%	27.1%	4.0%	0%	35.7%	-	1.2%	8.8%	1.3%	0%	11.2%	-	2.9%	30.3%	4.2%	0.1%	37.4%	-	-
<b>PHF</b>	0.679	0.935	0.861	0.500	0.917	-	0.800	0.879	0.951	-	0.913	-	0.804	0.792	0.766	-	0.859	-	0.750	0.963	0.856	0.500	0.979	-	0.945
<b>Lights</b>	57	376	154	4	591	-	174	1018	155	0	1347	-	44	331	46	0	421	-	110	1138	158	2	1408	-	3767
<b>% Lights</b>	100%	96.7%	99.4%	100%	97.7%	-	98.9%	97.1%	99.4%	0%	97.6%	-	97.8%	97.6%	93.9%	0%	97.2%	-	99.1%	97.2%	98.1%	100%	97.4%	-	97.5%
<b>Articulated Trucks and Single-Unit Trucks</b>	0	6	1	0	7	-	0	19	0	0	19	-	1	1	1	0	3	-	0	27	3	0	30	-	59
<b>% Articulated Trucks and Single-Unit Trucks</b>	0%	1.5%	0.6%	0%	1.2%	-	0%	1.8%	0%	0%	1.4%	-	2.2%	0.3%	2.0%	0%	0.7%	-	0%	2.3%	1.9%	0%	2.1%	-	1.5%
<b>Buses</b>	0	7	0	0	7	-	2	11	1	0	14	-	0	7	2	0	9	-	1	6	0	0	7	-	37
<b>% Buses</b>	0%	1.8%	0%	0%	1.2%	-	1.1%	1.0%	0.6%	0%	1.0%	-	0%	2.1%	4.1%	0%	2.1%	-	0.9%	0.5%	0%	0%	0.5%	-	1.0%
<b>Pedestrians</b>	-	-	-	-	-	6	-	-	-	-	-	9	-	-	-	-	-	12	-	-	-	-	-	11	
<b>% Pedestrians</b>	-	-	-	-	-	66.7%	-	-	-	-	-	81.8%	-	-	-	-	-	92.3%	-	-	-	-	-	64.7%	
<b>Bicycles on Crosswalk</b>	-	-	-	-	-	3	-	-	-	-	-	2	-	-	-	-	-	1	-	-	-	-	-	6	
<b>% Bicycles on Crosswalk</b>	-	-	-	-	-	33.3%	-	-	-	-	-	18.2%	-	-	-	-	-	7.7%	-	-	-	-	-	35.3%	

\*Pedestrians and Bicycles on Crosswalk. L: Left, R: Right, T: Thru, U: U-Turn

**Ponce De Leon Boulevard and SR 976 Bird Road - TMC**

Tue Jan 28, 2020

AM Peak (8 AM - 9 AM)

All Classes (Lights, Articulated Trucks and Single-Unit Trucks, Buses, Pedestrians, Bicycles on Crosswalk)

All Movements

ID: 745287, Location: 25.734923, -80.258581, Site Code: Ponce De Leon Boulevard and SR 976 Bird Road



Provided by: Apcte  
10305 NW 41st Street, Suite 115,  
Doral, FL, 33178, US

**[N] Ponce De Leon Boulevard**

Total: 1285  
In: 605 Out: 680

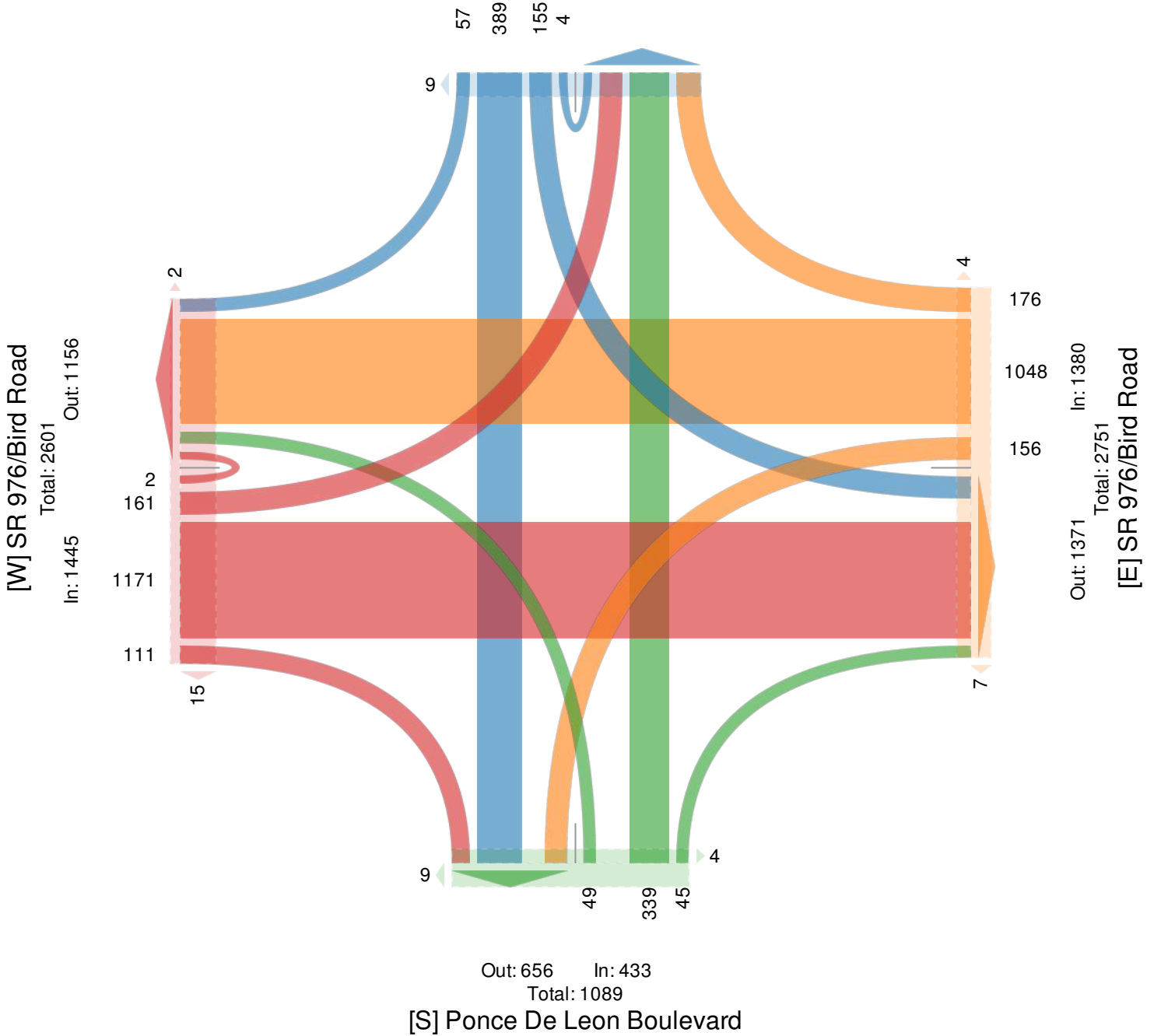

**Ponce De Leon Boulevard and SR976Bird Road - TMC**

Tue Jan 28, 2020

PM Peak (4:45 PM - 5:45 PM) - Overall Peak Hour

All Classes (Lights, Articulated Trucks and Single-Unit Trucks, Buses, Pedestrians, Bicycles on Crosswalk)

All Movements

ID: 745287, Location: 25.734923, -80.258581, Site Code: Ponce De Leon Boulevard and SR 976Bird Road



Provided by: Apcte

10305 NW 41st Street, Suite 115, Doral, FL, 33178, US

Leg Direction	Ponce De Leon Boulevard Southbound						SR976/Bird Road Westbound						Ponce De Leon Boulevard Northbound						SR 976/Bird Road Eastbound						Int
	R	T	L	U	App	Ped*	R	T	L	U	App	Ped*	R	T	L	U	App	Ped*	R	T	L	U	App	Ped*	
2020-01-28 4:45PM	35	72	33	5	145	3	24	382	28	0	434	2	13	72	28	0	113	4	26	244	31	0	301	4	993
5:00PM	45	102	19	1	167	2	33	395	39	0	467	3	18	86	23	0	127	2	16	255	24	0	295	9	1056
5:15PM	26	112	31	2	171	1	32	390	27	0	449	5	17	73	28	0	118	8	20	251	34	0	305	4	1043
5:30PM	36	115	28	1	180	8	27	345	28	0	400	3	16	88	19	0	123	7	14	256	40	0	310	10	1013
<b>Total</b>	142	401	111	9	663	14	116	1512	122	0	1750	13	64	319	98	0	481	21	76	1006	129	0	1211	27	4105
<b>% Approach</b>	21.4%	60.5%	16.7%	1.4%	-	-	6.6%	86.4%	7.0%	0%	-	-	13.3%	66.3%	20.4%	0%	-	-	6.3%	83.1%	10.7%	0%	-	-	-
<b>% Total</b>	3.5%	9.8%	2.7%	0.2%	16.2%	-	2.8%	36.8%	3.0%	0%	42.6%	-	1.6%	7.8%	2.4%	0%	11.7%	-	1.9%	24.5%	3.1%	0%	29.5%	-	-
<b>PHF</b>	0.789	0.872	0.841	0.450	0.921	-	0.879	0.957	0.782	-	0.937	-	0.889	0.906	0.875	-	0.947	-	0.731	0.982	0.806	-	0.977	-	0.972
<b>Lights</b>	140	392	110	9	651	-	115	1492	122	0	1729	-	64	311	96	0	471	-	74	995	127	0	1196	-	4047
<b>% Lights</b>	98.6%	97.8%	99.1%	100%	98.2%	-	99.1%	98.7%	100%	0%	98.8%	-	100%	97.5%	98.0%	0%	97.9%	-	97.4%	98.9%	98.4%	0%	98.8%	-	98.6%
<b>Articulated Trucks and Single-Unit Trucks</b>	2	3	1	0	6	-	1	11	0	0	12	-	0	3	2	0	5	-	2	4	2	0	8	-	31
<b>% Articulated Trucks and Single-Unit Trucks</b>	1.4%	0.7%	0.9%	0%	0.9%	-	0.9%	0.7%	0%	0%	0.7%	-	0%	0.9%	2.0%	0%	1.0%	-	2.6%	0.4%	1.6%	0%	0.7%	-	0.8%
<b>Buses</b>	0	6	0	0	6	-	0	9	0	0	9	-	0	5	0	0	5	-	0	7	0	0	7	-	27
<b>% Buses</b>	0%	1.5%	0%	0%	0.9%	-	0%	0.6%	0%	0%	0.5%	-	0%	1.6%	0%	0%	1.0%	-	0%	0.7%	0%	0%	0.6%	-	0.7%
<b>Pedestrians</b>	-	-	-	-	-	13	-	-	-	-	-	8	-	-	-	-	-	18	-	-	-	-	-	26	-
<b>% Pedestrians</b>	-	-	-	-	-	92.9%	-	-	-	-	-	61.5%	-	-	-	-	-	85.7%	-	-	-	-	-	96.3%	-
<b>Bicycles on Crosswalk</b>	-	-	-	-	-	1	-	-	-	-	-	5	-	-	-	-	-	3	-	-	-	-	-	1	-
<b>% Bicycles on Crosswalk</b>	-	-	-	-	-	7.1%	-	-	-	-	-	38.5%	-	-	-	-	-	14.3%	-	-	-	-	-	3.7%	-

\*Pedestrians and Bicycles on Crosswalk. L: Left, R: Right, T: Thru, U: U-Turn

**Ponce De Leon Boulevard and SR 976 Bird Road - TMC**

Tue Jan 28, 2020

PM Peak (4:45 PM - 5:45 PM) - Overall Peak Hour

All Classes (Lights, Articulated Trucks and Single-Unit Trucks, Buses, Pedestrians, Bicycles on Crosswalk)

All Movements

ID: 745287, Location: 25.734923, -80.258581, Site Code: Ponce De Leon Boulevard and SR 976 Bird Road



Provided by: Apcte  
10305 NW 41st Street, Suite 115,  
Doral, FL, 33178, US

**[N] Ponce De Leon Boulevard**

Total: 1236

In: 663 Out: 573

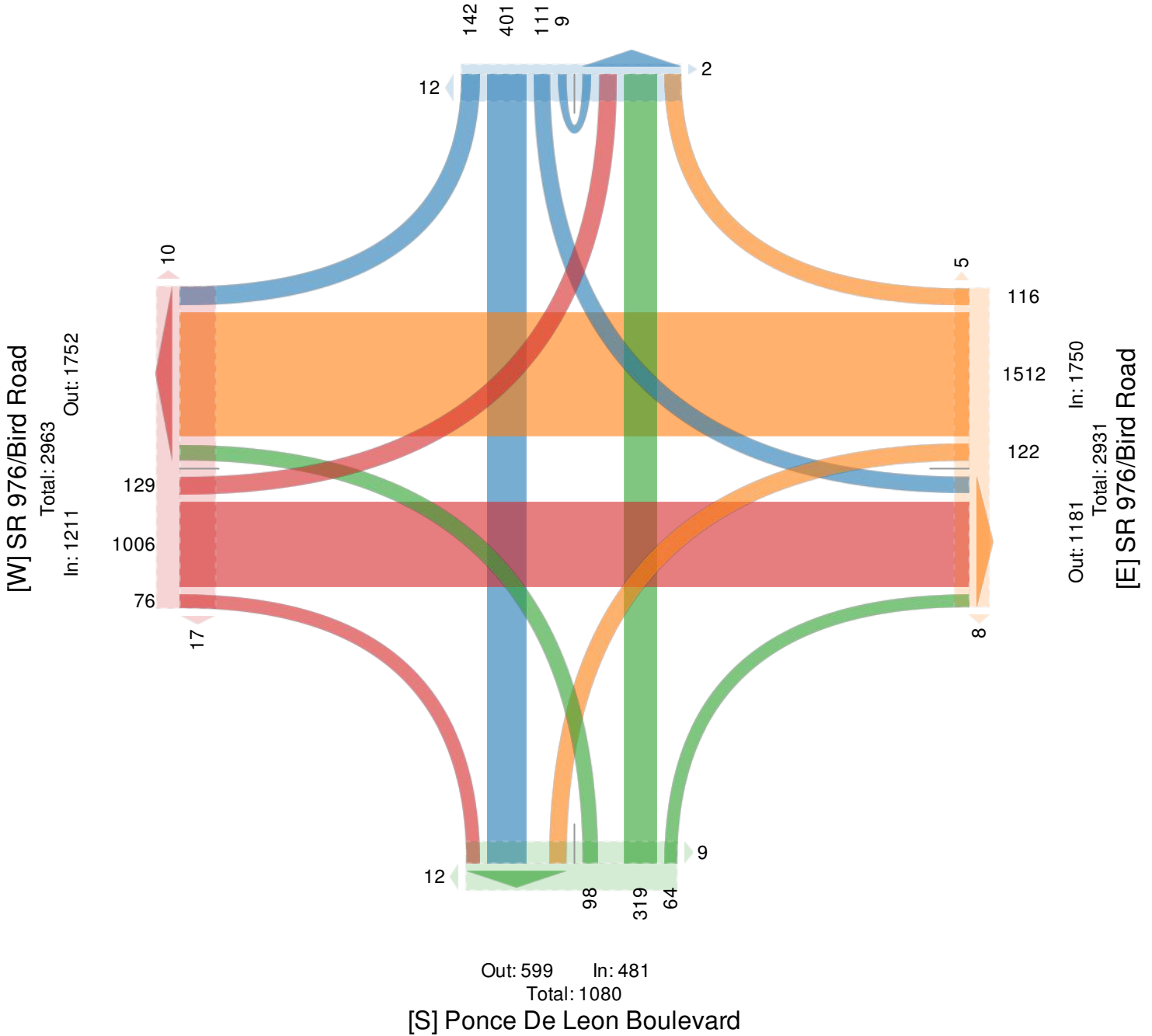

# Ponce De Leon Boulevard and San Lorenzo Aven... - TMC

Tue Jan 28, 2020

Full Length (7 AM-9 AM, 4 PM-6 PM)

All Classes (Lights, Articulated Trucks and Single-Unit Trucks, Buses, Pedestrians, Bicycles on Crosswalk)

All Movements

ID: 745285, Location: 25.732246, -80.25843, Site Code: Ponce De Leon Boulevard and San Lorenzo Avenue



Provided by: Apcte  
10305 NW 41st Street, Suite 115,  
Doral, FL, 33178, US

Leg Direction	Ponce De Leon Boulevard Southbound					Ponce De Leon Boulevard Northbound					San Lorenzo Avenue Eastbound					Int
	R	T	U	App	Ped*	T	L	U	App	Ped*	R	L	U	App	Ped*	
Time																
2020-01-28 7:00AM	14	89	1	104	20	90	50	1	141	6	27	16	0	43	3	288
7:15AM	8	131	0	139	13	73	25	1	99	3	8	6	0	14	7	252
7:30AM	3	98	0	101	3	72	4	0	76	5	4	2	0	6	8	183
7:45AM	3	119	0	122	1	82	3	1	86	1	8	6	0	14	12	222
Hourly Total	28	437	1	466	37	317	82	3	402	15	47	30	0	77	30	945
8:00AM	4	126	0	130	1	110	4	0	114	5	2	1	0	3	7	247
8:15AM	6	139	0	145	0	121	9	4	134	5	6	2	0	8	7	287
8:30AM	4	134	1	139	1	113	4	0	117	6	7	1	0	8	6	264
8:45AM	8	119	0	127	0	115	9	10	134	7	8	4	0	12	6	273
Hourly Total	22	518	1	541	2	459	26	14	499	23	23	8	0	31	26	1071
4:00PM	12	103	1	116	4	155	11	5	171	10	6	4	0	10	23	297
4:15PM	12	92	3	107	4	111	12	5	128	15	6	4	0	10	13	245
4:30PM	14	104	1	119	1	124	11	3	138	13	11	6	0	17	7	274
4:45PM	20	95	1	116	2	108	14	4	126	11	14	5	0	19	17	261
Hourly Total	58	394	6	458	11	498	48	17	563	49	37	19	0	56	60	1077
5:00PM	24	115	0	139	1	108	10	5	123	22	10	6	0	16	22	278
5:15PM	17	115	1	133	0	100	16	2	118	21	10	6	0	16	15	267
5:30PM	13	128	1	142	4	111	7	2	120	19	10	7	0	17	15	279
5:45PM	18	108	0	126	0	110	9	2	121	14	7	7	0	14	6	261
Hourly Total	72	466	2	540	5	429	42	11	482	76	37	26	0	63	58	1085
<b>Total</b>	180	1815	10	2005	55	1703	198	45	1946	163	144	83	0	227	174	4178
<b>% Approach</b>	9.0%	90.5%	0.5%	-	-	87.5%	10.2%	2.3%	-	-	63.4%	36.6%	0%	-	-	-
<b>% Total</b>	4.3%	43.4%	0.2%	48.0%	-	40.8%	4.7%	1.1%	46.6%	-	3.4%	2.0%	0%	5.4%	-	-
<b>Lights</b>	180	1773	10	1963	-	1664	195	45	1904	-	138	81	0	219	-	4086
<b>% Lights</b>	100%	97.7%	100%	97.9%	-	97.7%	98.5%	100%	97.8%	-	95.8%	97.6%	0%	96.5%	-	97.8%
<b>Articulated Trucks and Single-Unit Trucks</b>	0	16	0	16	-	11	3	0	14	-	6	2	0	8	-	38
<b>% Articulated Trucks and Single-Unit Trucks</b>	0%	0.9%	0%	0.8%	-	0.6%	1.5%	0%	0.7%	-	4.2%	2.4%	0%	3.5%	-	0.9%
<b>Buses</b>	0	26	0	26	-	28	0	0	28	-	0	0	0	0	-	54
<b>% Buses</b>	0%	1.4%	0%	1.3%	-	1.6%	0%	0%	1.4%	-	0%	0%	0%	0%	-	1.3%
<b>Pedestrians</b>	-	-	-	-	55	-	-	-	-	159	-	-	-	-	169	
<b>% Pedestrians</b>	-	-	-	-	100%	-	-	-	-	97.5%	-	-	-	-	97.1%	-
<b>Bicycles on Crosswalk</b>	-	-	-	-	0	-	-	-	-	4	-	-	-	-	5	
<b>% Bicycles on Crosswalk</b>	-	-	-	-	0%	-	-	-	-	2.5%	-	-	-	-	2.9%	-

\* Pedestrians and Bicycles on Crosswalk. L: Left, R: Right, T: Thru, U: U-Turn

**Ponce De Leon Boulevard and San Lorenzo Aven... - TMC**

Tue Jan 28, 2020

Full Length (7 AM-9 AM, 4 PM-6 PM)

All Classes (Lights, Articulated Trucks and Single-Unit Trucks, Buses, Pedestrians, Bicycles on Crosswalk)

All Movements

ID: 745285, Location: 25.732246, -80.25843, Site Code: Ponce De Leon Boulevard and San Lorenzo Avenue



Provided by: Apcte  
10305 NW 41st Street, Suite 115,  
Doral, FL, 33178, US

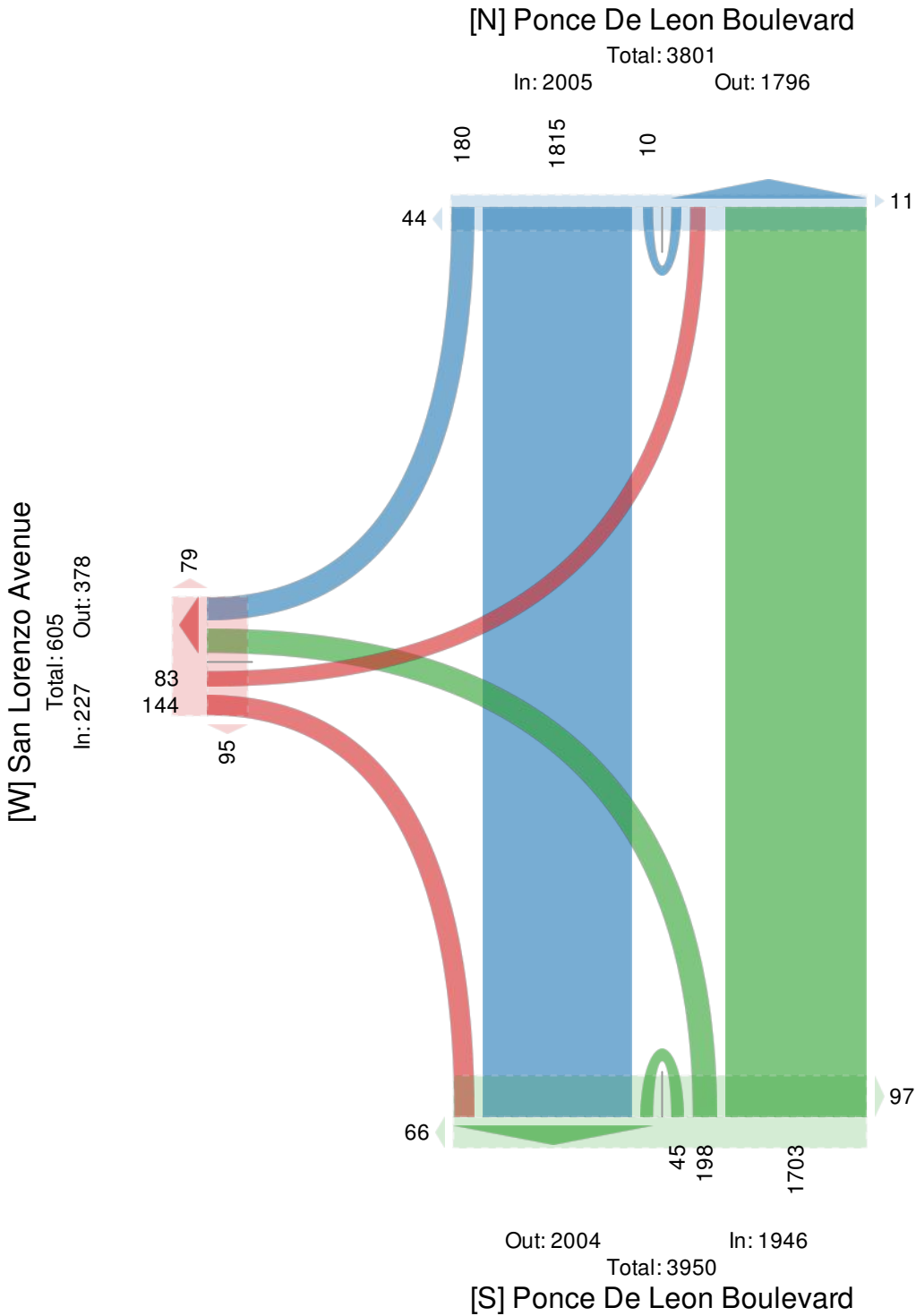



**Ponce De Leon Boulevard and San Lorenzo Aven... - TMC**

Tue Jan 28, 2020

AM Peak (8 AM - 9 AM)

All Classes (Lights, Articulated Trucks and Single-Unit Trucks, Buses, Pedestrians, Bicycles on Crosswalk)

All Movements

ID: 745285, Location: 25.732246, -80.25843, Site Code: Ponce De Leon Boulevard and San Lorenzo Avenue



Provided by: Apcte  
10305 NW 41st Street, Suite 115,  
Doral, FL, 33178, US

Leg Direction	Ponce De Leon Boulevard Southbound					Ponce De Leon Boulevard Northbound					San Lorenzo Avenue Eastbound				Int	
	R	T	U	App	Ped*	T	L	U	App	Ped*	R	L	U	App		Ped*
2020-01-28 8:00AM	4	126	0	130	1	110	4	0	114	5	2	1	0	3	7	247
8:15AM	6	139	0	145	0	121	9	4	134	5	6	2	0	8	7	287
8:30AM	4	134	1	139	1	113	4	0	117	6	7	1	0	8	6	264
8:45AM	8	119	0	127	0	115	9	10	134	7	8	4	0	12	6	273
<b>Total</b>	22	518	1	541	2	459	26	14	499	23	23	8	0	31	26	1071
<b>% Approach</b>	4.1%	95.7%	0.2%	-	-	92.0%	5.2%	2.8%	-	-	74.2%	25.8%	0%	-	-	-
<b>% Total</b>	2.1%	48.4%	0.1%	50.5%	-	42.9%	2.4%	1.3%	46.6%	-	2.1%	0.7%	0%	2.9%	-	-
<b>PHF</b>	0.688	0.932	0.250	0.933	-	0.948	0.722	0.350	0.931	-	0.719	0.500	-	0.646	-	0.933
<b>Lights</b>	22	507	1	530	-	447	25	14	486	-	22	7	0	29	-	1045
<b>% Lights</b>	100%	97.9%	100%	98.0%	-	97.4%	96.2%	100%	97.4%	-	95.7%	87.5%	0%	93.5%	-	97.6%
<b>Articulated Trucks and Single-Unit Trucks</b>	0	3	0	3	-	3	1	0	4	-	1	1	0	2	-	9
<b>% Articulated Trucks and Single-Unit Trucks</b>	0%	0.6%	0%	0.6%	-	0.7%	3.8%	0%	0.8%	-	4.3%	12.5%	0%	6.5%	-	0.8%
<b>Buses</b>	0	8	0	8	-	9	0	0	9	-	0	0	0	0	-	17
<b>% Buses</b>	0%	1.5%	0%	1.5%	-	2.0%	0%	0%	1.8%	-	0%	0%	0%	0%	-	1.6%
Pedestrians	-	-	-	-	2	-	-	-	-	23	-	-	-	-	25	-
<b>% Pedestrians</b>	-	-	-	-	100%	-	-	-	-	100%	-	-	-	-	96.2%	-
Bicycles on Crosswalk	-	-	-	-	0	-	-	-	-	0	-	-	-	-	1	-
<b>% Bicycles on Crosswalk</b>	-	-	-	-	0%	-	-	-	-	0%	-	-	-	-	3.8%	-

\*Pedestrians and Bicycles on Crosswalk. L: Left, R: Right, T: Thru, U: U-Turn

**Ponce De Leon Boulevard and San Lorenzo Aven... - TMC**

Tue Jan 28, 2020

AM Peak (8 AM - 9 AM)

All Classes (Lights, Articulated Trucks and Single-Unit Trucks, Buses, Pedestrians, Bicycles on Crosswalk)

All Movements

ID: 745285, Location: 25.732246, -80.25843, Site Code: Ponce De Leon Boulevard and San Lorenzo Avenue



Provided by: Apcte  
10305 NW 41st Street, Suite 115,  
Doral, FL, 33178, US

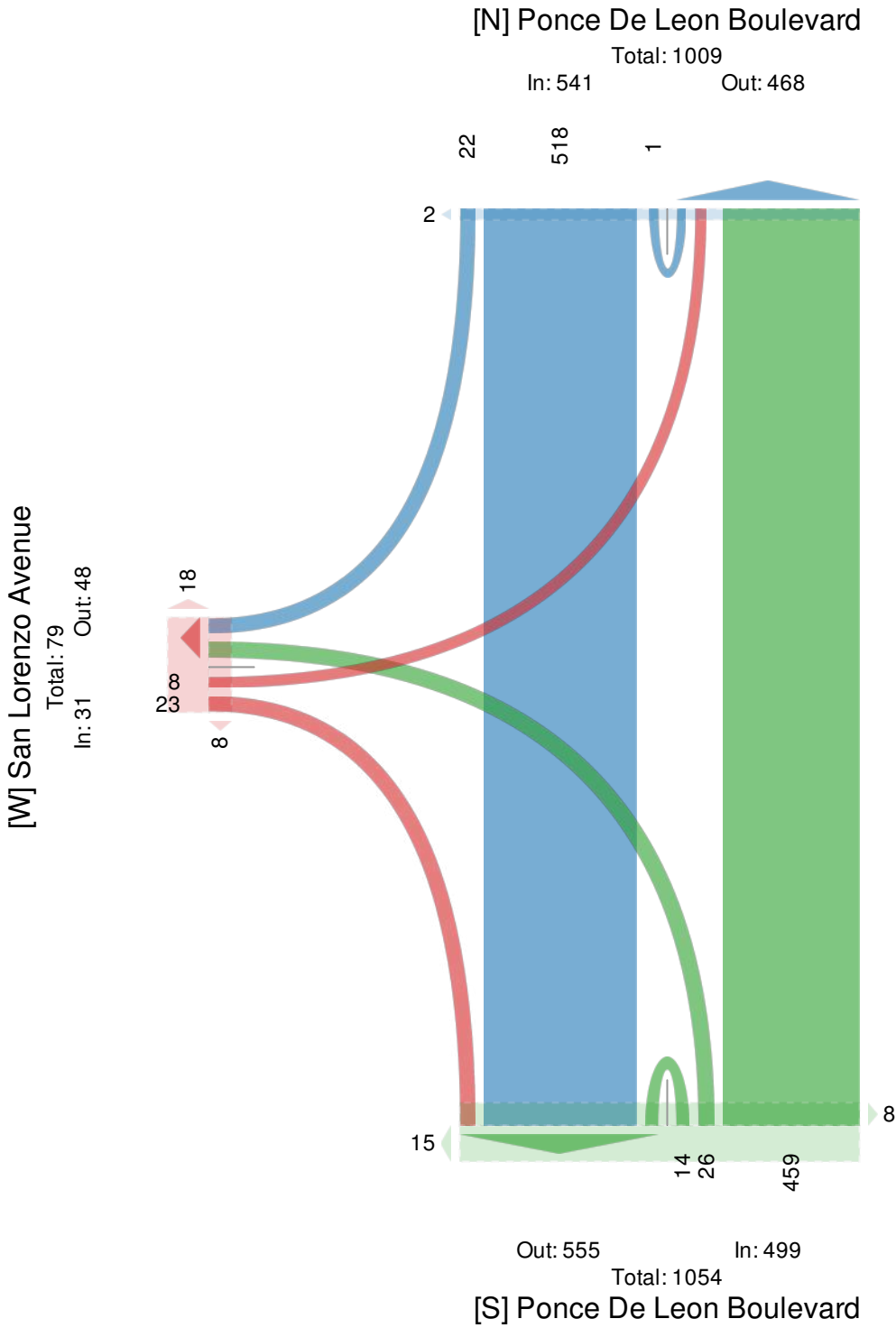

**Ponce De Leon Boulevard and San Lorenzo Aven... - TMC**

Tue Jan 28, 2020

PM Peak (4:45 PM - 5:45 PM) - Overall Peak Hour

All Classes (Lights, Articulated Trucks and Single-Unit Trucks, Buses, Pedestrians, Bicycles on Crosswalk)

All Movements

ID: 745285, Location: 25.732246, -80.25843, Site Code: Ponce De Leon Boulevard and San Lorenzo Avenue



Provided by: Apcte  
10305 NW 41st Street, Suite 115,  
Doral, FL, 33178, US

Leg Direction	Ponce De Leon Boulevard Southbound					Ponce De Leon Boulevard Northbound					San Lorenzo Avenue Eastbound					Int
	R	T	U	App	Ped*	T	L	U	App	Ped*	R	L	U	App	Ped*	
Time																
2020-01-28 4:45PM	20	95	1	<b>116</b>	2	108	14	4	<b>126</b>	11	14	5	0	<b>19</b>	17	<b>261</b>
5:00PM	24	115	0	<b>139</b>	1	108	10	5	<b>123</b>	22	10	6	0	<b>16</b>	22	<b>278</b>
5:15PM	17	115	1	<b>133</b>	0	100	16	2	<b>118</b>	21	10	6	0	<b>16</b>	15	<b>267</b>
5:30PM	13	128	1	<b>142</b>	4	111	7	2	<b>120</b>	19	10	7	0	<b>17</b>	15	<b>279</b>
<b>Total</b>	74	453	3	<b>530</b>	7	427	47	13	<b>487</b>	73	44	24	0	<b>68</b>	69	<b>1085</b>
<b>% Approach</b>	14.0%	85.5%	0.6%	-	-	87.7%	9.7%	2.7%	-	-	64.7%	35.3%	0%	-	-	-
<b>% Total</b>	6.8%	41.8%	0.3%	<b>48.8%</b>	-	39.4%	4.3%	1.2%	<b>44.9%</b>	-	4.1%	2.2%	0%	<b>6.3%</b>	-	-
<b>PHF</b>	0.771	0.885	0.750	<b>0.933</b>	-	0.962	0.734	0.650	<b>0.966</b>	-	0.786	0.857	-	<b>0.895</b>	-	0.972
<b>Lights</b>	74	444	3	<b>521</b>	-	418	47	13	<b>478</b>	-	44	24	0	<b>68</b>	-	1067
<b>% Lights</b>	100%	98.0%	100%	<b>98.3%</b>	-	97.9%	100%	100%	<b>98.2%</b>	-	100%	100%	0%	<b>100%</b>	-	98.3%
<b>Articulated Trucks and Single-Unit Trucks</b>	0	3	0	<b>3</b>	-	3	0	0	<b>3</b>	-	0	0	0	<b>0</b>	-	6
<b>% Articulated Trucks and Single-Unit Trucks</b>	0%	0.7%	0%	<b>0.6%</b>	-	0.7%	0%	0%	<b>0.6%</b>	-	0%	0%	0%	<b>0%</b>	-	0.6%
<b>Buses</b>	0	6	0	<b>6</b>	-	6	0	0	<b>6</b>	-	0	0	0	<b>0</b>	-	12
<b>% Buses</b>	0%	1.3%	0%	<b>1.1%</b>	-	1.4%	0%	0%	<b>1.2%</b>	-	0%	0%	0%	<b>0%</b>	-	1.1%
Pedestrians	-	-	-	-	7	-	-	-	-	72	-	-	-	-	69	
<b>% Pedestrians</b>	-	-	-	-	100%	-	-	-	-	98.6%	-	-	-	-	100%	-
Bicycles on Crosswalk	-	-	-	-	0	-	-	-	-	1	-	-	-	-	0	
<b>% Bicycles on Crosswalk</b>	-	-	-	-	0%	-	-	-	-	1.4%	-	-	-	-	0%	-

\*Pedestrians and Bicycles on Crosswalk. L: Left, R: Right, T: Thru, U: U-Turn

**Ponce De Leon Boulevard and San Lorenzo Aven... - TMC**

Tue Jan 28, 2020

PM Peak (4:45 PM - 5:45 PM) - Overall Peak Hour

All Classes (Lights, Articulated Trucks and Single-Unit Trucks, Buses, Pedestrians, Bicycles on Crosswalk)

All Movements

ID: 745285, Location: 25.732246, -80.25843, Site Code: Ponce De Leon Boulevard and San Lorenzo Avenue



Provided by: Apcte  
10305 NW 41st Street, Suite 115,  
Doral, FL, 33178, US

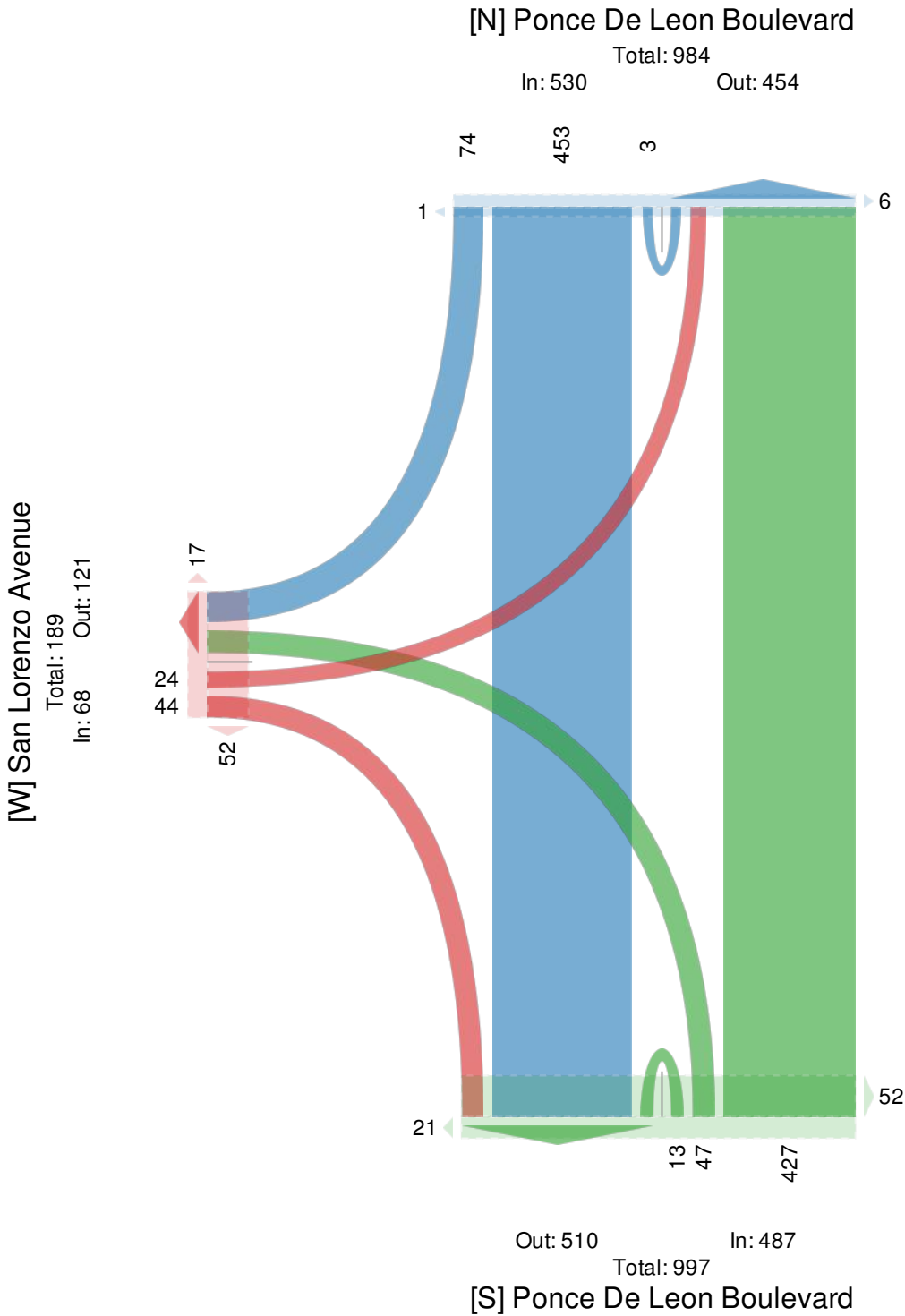

**Ponce De Leon Boulevard and Altara Avenue - TMC**

Tue Jan 28, 2020

Full Length (7 AM-9 AM, 4 PM-6 PM)

All Classes (Lights, Articulated Trucks and Single-Unit Trucks, Buses, Pedestrians, Bicycles on

Crosswalk)

All Movements

ID: 745284, Location: 25.733181, -80.258485, Site Code: Ponce De Leon Boulevard and Altara Avenue



Provided by: Apcte  
10305 NW 41st Street, Suite 115,  
Doral, FL, 33178, US

Leg Direction	Ponce De Leon Boulevard Southbound						East Westbound						Ponce De Leon Boulevard Northbound						Altara Avenue Eastbound						Int
	R	T	L	U	App	Ped*	R	T	L	U	App	Ped*	R	T	L	U	App	Ped*	R	T	L	U	App	Ped*	
2020-01-28 7:00AM	95	68	0	1	164	0	0	0	0	0	0	6	0	92	10	0	102	5	32	0	27	0	59	8	325
7:15AM	49	110	0	0	159	0	0	0	0	0	0	7	0	78	10	0	88	4	14	0	17	0	31	3	278
7:30AM	12	92	0	0	104	0	0	0	0	0	0	1	0	71	5	0	76	1	8	0	3	0	11	5	191
7:45AM	14	116	0	1	131	0	0	0	0	0	0	2	0	78	5	1	84	6	9	0	7	0	16	14	231
Hourly Total	170	386	0	2	558	0	0	0	0	0	0	16	0	319	30	1	350	16	63	0	54	0	117	30	1025
8:00AM	25	126	0	1	152	1	1	0	0	0	1	9	0	93	7	0	100	1	9	0	2	0	11	8	264
8:15AM	25	133	0	0	158	0	0	0	0	0	0	12	1	114	11	0	126	8	7	0	7	0	14	11	298
8:30AM	30	127	0	0	157	0	2	0	0	0	2	8	0	100	13	0	113	3	8	0	5	0	13	4	285
8:45AM	38	115	0	2	155	1	1	0	1	0	2	4	0	110	9	0	119	2	4	0	6	0	10	12	286
Hourly Total	118	501	0	3	622	2	4	0	1	0	5	33	1	417	40	0	458	14	28	0	20	0	48	35	1133
4:00PM	23	105	2	0	130	2	2	0	0	0	2	9	1	153	12	1	167	9	16	0	6	0	22	13	321
4:15PM	17	93	2	0	112	0	3	0	0	0	3	8	2	101	12	0	115	3	16	0	5	0	21	7	251
4:30PM	21	101	3	0	125	0	4	0	0	0	4	12	2	110	10	0	122	4	19	0	9	0	28	2	279
4:45PM	22	100	0	1	123	0	0	0	1	0	1	8	0	107	4	0	111	2	16	0	13	0	29	8	264
Hourly Total	83	399	7	1	490	2	9	0	1	0	10	37	5	471	38	1	515	18	67	0	33	0	100	30	1115
5:00PM	25	119	0	0	144	0	2	0	0	0	2	14	1	113	9	1	124	5	23	0	12	0	35	18	305
5:15PM	23	127	1	1	152	1	0	0	0	0	0	15	0	99	10	0	109	6	11	0	10	0	21	8	282
5:30PM	24	127	0	0	151	1	1	0	0	0	1	6	0	111	10	1	122	5	9	0	13	0	22	6	296
5:45PM	26	117	0	0	143	0	0	0	1	0	1	13	1	106	6	0	113	3	14	0	9	0	23	6	280
Hourly Total	98	490	1	1	590	2	3	0	1	0	4	48	2	429	35	2	468	19	57	0	44	0	101	38	1163
<b>Total</b>	469	1776	8	7	2260	6	16	0	3	0	19	134	8	1636	143	4	1791	67	215	0	151	0	366	133	4436
<b>% Approach</b>	20.8%	78.6%	0.4%	0.3%	-	-	84.2%	0%	15.8%	0%	-	-	0.4%	91.3%	8.0%	0.2%	-	-	58.7%	0%	41.3%	0%	-	-	-
<b>% Total</b>	10.6%	40.0%	0.2%	0.2%	50.9%	-	0.4%	0%	0.1%	0%	0.4%	-	0.2%	36.9%	3.2%	0.1%	40.4%	-	4.8%	0%	3.4%	0%	8.3%	-	-
<b>Lights</b>	461	1734	8	7	2210	-	16	0	3	0	19	-	8	1598	141	4	1751	-	214	0	150	0	364	-	4344
<b>% Lights</b>	98.3%	97.6%	100%	100%	97.8%	-	100%	0%	100%	0%	100%	-	100%	97.7%	98.6%	100%	97.8%	-	99.5%	0%	99.3%	0%	99.5%	-	97.9%
<b>Articulated Trucks and Single-Unit Trucks</b>	8	14	0	0	22	-	0	0	0	0	0	-	0	11	2	0	13	-	1	0	1	0	2	-	37
<b>% Articulated Trucks and Single-Unit Trucks</b>	1.7%	0.8%	0%	0%	1.0%	-	0%	0%	0%	0%	0%	-	0%	0.7%	1.4%	0%	0.7%	-	0.5%	0%	0.7%	0%	0.5%	-	0.8%
<b>Buses</b>	0	28	0	0	28	-	0	0	0	0	0	-	0	27	0	0	27	-	0	0	0	0	0	-	55
<b>% Buses</b>	0%	1.6%	0%	0%	1.2%	-	0%	0%	0%	0%	0%	-	0%	1.7%	0%	0%	1.5%	-	0%	0%	0%	0%	0%	-	1.2%
<b>Pedestrians</b>	-	-	-	-	-	6	-	-	-	-	-	125	-	-	-	-	-	67	-	-	-	-	-	125	
<b>% Pedestrians</b>	-	-	-	-	-	100%	-	-	-	-	-	93.3%	-	-	-	-	-	100%	-	-	-	-	-	94.0%	-
<b>Bicycles on Crosswalk</b>	-	-	-	-	-	0	-	-	-	-	-	9	-	-	-	-	-	0	-	-	-	-	-	8	
<b>% Bicycles on Crosswalk</b>	-	-	-	-	-	0%	-	-	-	-	-	6.7%	-	-	-	-	-	0%	-	-	-	-	-	6.0%	-

\*Pedestrians and Bicycles on Crosswalk. L: Left, R: Right, T: Thru, U: U-Turn

**Ponce De Leon Boulevard and Altara Avenue - TMC**

Tue Jan 28, 2020

Full Length (7 AM-9 AM, 4 PM-6 PM)

All Classes (Lights, Articulated Trucks and Single-Unit Trucks, Buses, Pedestrians, Bicycles on Crosswalk)

All Movements

ID: 745284, Location: 25.733181, -80.258485, Site Code: Ponce De Leon Boulevard and Altara Avenue



Provided by: Apcte  
10305 NW 41st Street, Suite 115,  
Doral, FL, 33178, US

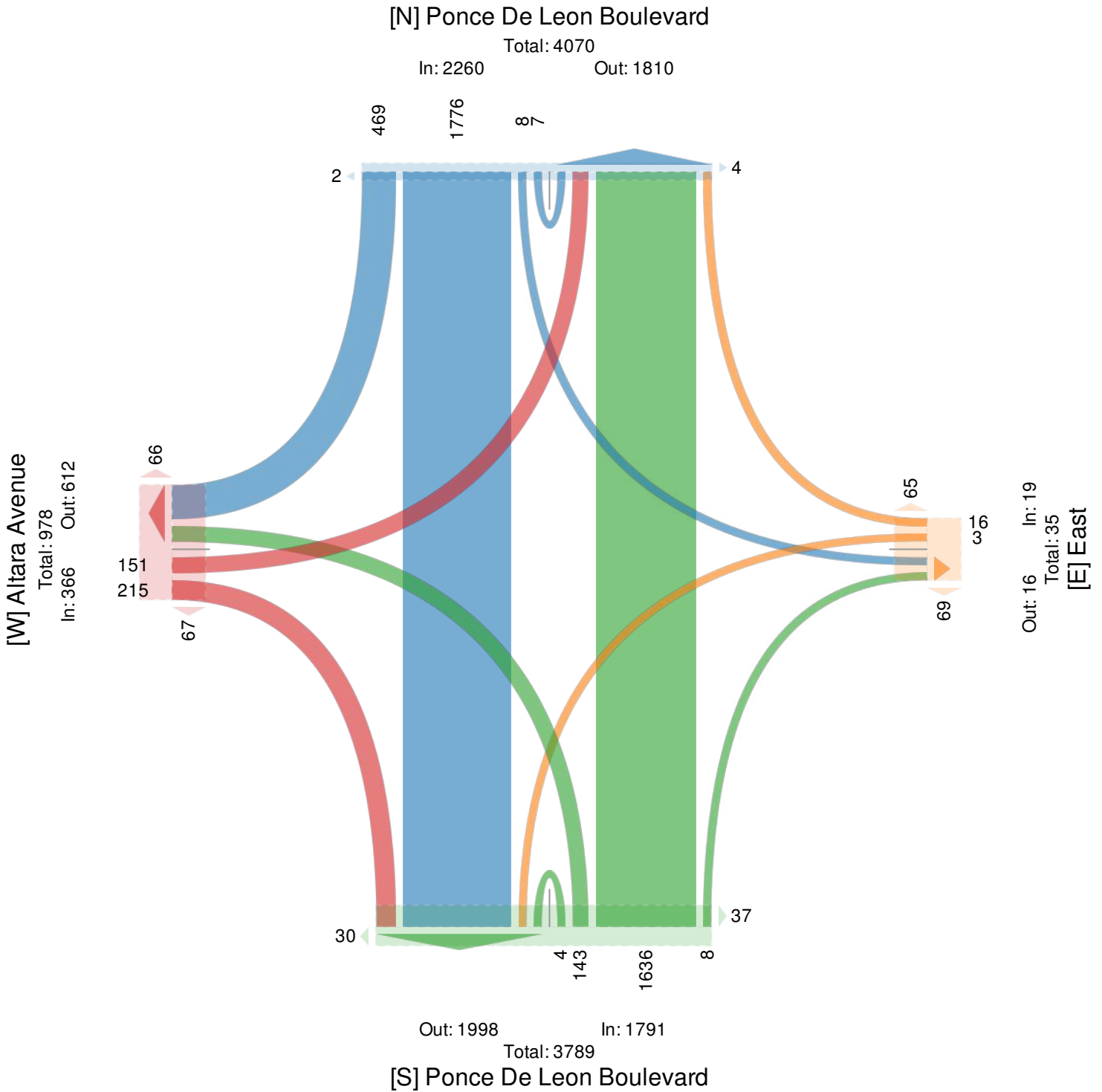

**Ponce De Leon Boulevard and Altara Avenue - TMC**

Tue Jan 28, 2020

AM Peak (8 AM - 9 AM)

All Classes (Lights, Articulated Trucks and Single-Unit Trucks, Buses, Pedestrians, Bicycles on Crosswalk)

All Movements

ID: 745284, Location: 25.733181, -80.258485, Site Code: Ponce De Leon Boulevard and Altara Avenue



Provided by: Apctc  
10305 NW 41st Street, Suite 115,  
Doral, FL, 33178, US

Leg Direction	Ponce De Leon Boulevard Southbound						East Westbound						Ponce De Leon Boulevard Northbound						Altara Avenue Eastbound						
Time	R	T	L	U	App	Ped*	R	T	L	U	App	Ped*	R	T	L	U	App	Ped*	R	T	L	U	App	Ped*	Int
2020-01-28 8:00AM	25	126	0	1	152	1	1	0	0	0	1	9	0	93	7	0	100	1	9	0	2	0	11	8	264
8:15AM	25	133	0	0	158	0	0	0	0	0	0	12	1	114	11	0	126	8	7	0	7	0	14	11	298
8:30AM	30	127	0	0	157	0	2	0	0	0	2	8	0	100	13	0	113	3	8	0	5	0	13	4	285
8:45AM	38	115	0	2	155	1	1	0	1	0	2	4	0	110	9	0	119	2	4	0	6	0	10	12	286
<b>Total</b>	118	501	0	3	622	2	4	0	1	0	5	33	1	417	40	0	458	14	28	0	20	0	48	35	1133
<b>% Approach</b>	19.0%	80.5%	0%	0.5%	-	-	80.0%	0%	20.0%	0%	-	-	0.2%	91.0%	8.7%	0%	-	-	58.3%	0%	41.7%	0%	-	-	-
<b>% Total</b>	10.4%	44.2%	0%	0.3%	54.9%	-	0.4%	0%	0.1%	0%	0.4%	-	0.1%	36.8%	3.5%	0%	40.4%	-	2.5%	0%	1.8%	0%	4.2%	-	-
<b>PHF</b>	0.776	0.942	-	0.375	0.984	-	0.500	-	0.250	-	0.625	-	0.250	0.914	0.769	-	0.909	-	0.778	-	0.714	-	0.857	-	0.951
<b>Lights</b>	116	490	0	3	609	-	4	0	1	0	5	-	1	405	40	0	446	-	28	0	20	0	48	-	1108
<b>% Lights</b>	98.3%	97.8%	0%	100%	97.9%	-	100%	0%	100%	0%	100%	-	100%	97.1%	100%	0%	97.4%	-	100%	0%	100%	0%	100%	-	97.8%
<b>Articulated Trucks and Single-Unit Trucks</b>	2	3	0	0	5	-	0	0	0	0	0	-	0	4	0	0	4	-	0	0	0	0	0	-	9
<b>% Articulated Trucks and Single-Unit Trucks</b>	1.7%	0.6%	0%	0%	0.8%	-	0%	0%	0%	0%	0%	-	0%	1.0%	0%	0%	0.9%	-	0%	0%	0%	0%	0%	-	0.8%
<b>Buses</b>	0	8	0	0	8	-	0	0	0	0	0	-	0	8	0	0	8	-	0	0	0	0	0	-	16
<b>% Buses</b>	0%	1.6%	0%	0%	1.3%	-	0%	0%	0%	0%	0%	-	0%	1.9%	0%	0%	1.7%	-	0%	0%	0%	0%	0%	-	1.4%
<b>Pedestrians</b>	-	-	-	-	-	2	-	-	-	-	-	31	-	-	-	-	-	14	-	-	-	-	-	34	
<b>% Pedestrians</b>	-	-	-	-	-	-100%	-	-	-	-	-	-93.9%	-	-	-	-	-	-100%	-	-	-	-	-	-97.1%	-
<b>Bicycles on Crosswalk</b>	-	-	-	-	-	0	-	-	-	-	-	2	-	-	-	-	-	0	-	-	-	-	-	1	
<b>% Bicycles on Crosswalk</b>	-	-	-	-	-	0%	-	-	-	-	-	6.1%	-	-	-	-	-	0%	-	-	-	-	-	2.9%	-

\*Pedestrians and Bicycles on Crosswalk. L: Left, R: Right, T: Thru, U: U-Turn

**Ponce De Leon Boulevard and Altara Avenue - TMC**

Tue Jan 28, 2020

AM Peak (8 AM - 9 AM)

All Classes (Lights, Articulated Trucks and Single-Unit Trucks, Buses, Pedestrians, Bicycles on Crosswalk)

All Movements

ID: 745284, Location: 25.733181, -80.258485, Site Code: Ponce De Leon Boulevard and Altara Avenue



Provided by: Apcte  
10305 NW 41st Street, Suite 115,  
Doral, FL, 33178, US

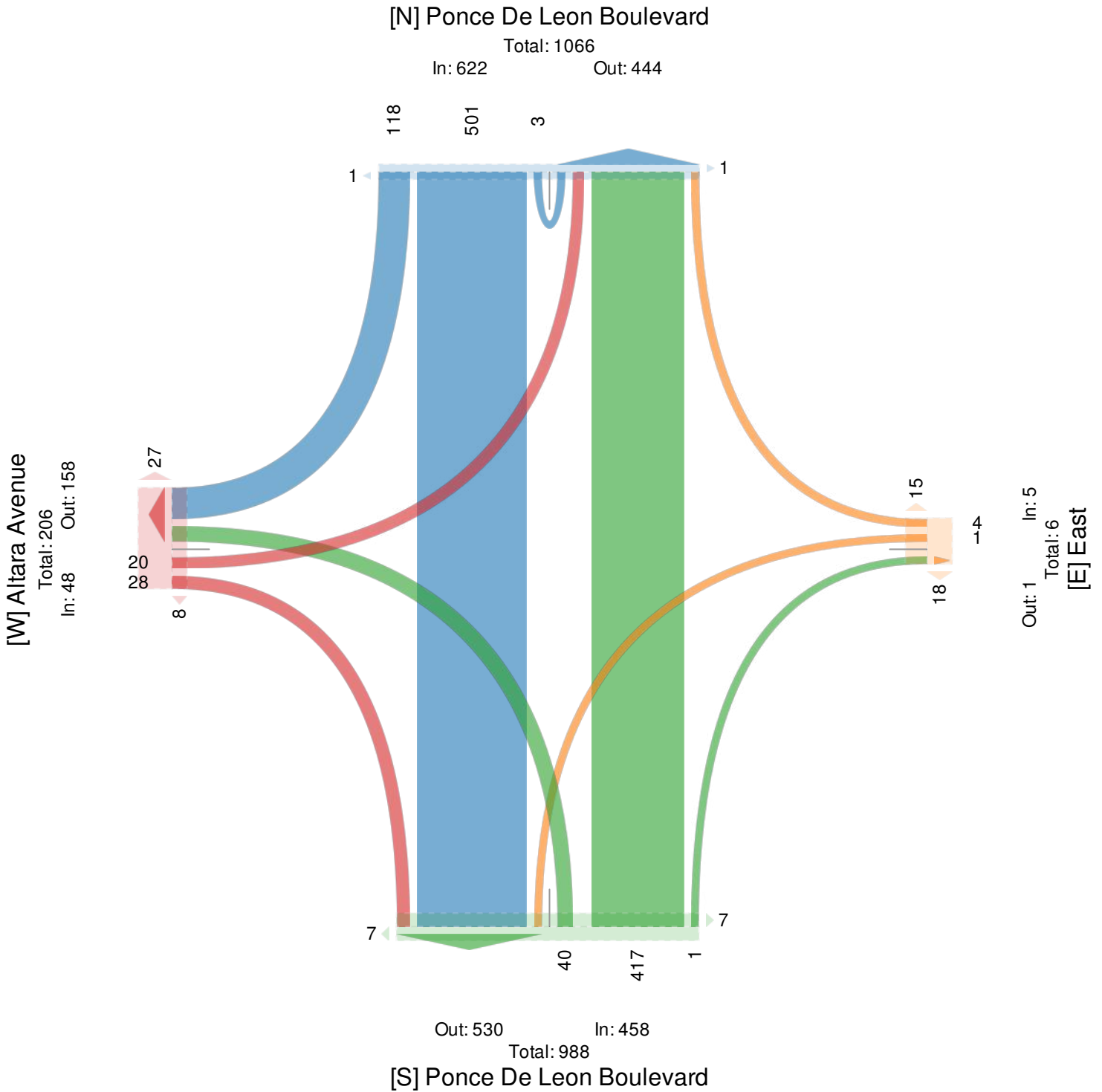



**Ponce De Leon Boulevard and Altara Avenue - TMC**

Tue Jan 28, 2020

PM Peak (5 PM - 6 PM) - Overall Peak Hour

All Classes (Lights, Articulated Trucks and Single-Unit Trucks, Buses, Pedestrians, Bicycles on

Crosswalk)

All Movements

ID: 745284, Location: 25.733181, -80.258485, Site Code: Ponce De Leon Boulevard and Altara Avenue



Provided by: Apcte  
10305 NW 41st Street, Suite 115,  
Doral, FL, 33178, US

Leg Direction	Ponce De Leon Boulevard Southbound						East Westbound						Ponce De Leon Boulevard Northbound						Altara Avenue Eastbound						Int
	R	T	L	U	App	Ped*	R	T	L	U	App	Ped*	R	T	L	U	App	Ped*	R	T	L	U	App	Ped*	
2020-01-28 5:00PM	25	119	0	0	144	0	2	0	0	0	2	14	1	113	9	1	124	5	23	0	12	0	35	18	305
5:15PM	23	127	1	1	152	1	0	0	0	0	0	15	0	99	10	0	109	6	11	0	10	0	21	8	282
5:30PM	24	127	0	0	151	1	1	0	0	0	1	6	0	111	10	1	122	5	9	0	13	0	22	6	296
5:45PM	26	117	0	0	143	0	0	0	1	0	1	13	1	106	6	0	113	3	14	0	9	0	23	6	280
<b>Total</b>	98	490	1	1	590	2	3	0	1	0	4	48	2	429	35	2	468	19	57	0	44	0	101	38	1163
<b>% Approach</b>	16.6%	83.1%	0.2%	0.2%	-	-	75.0%	0%	25.0%	0%	-	-	0.4%	91.7%	7.5%	0.4%	-	-	56.4%	0%	43.6%	0%	-	-	-
<b>% Total</b>	8.4%	42.1%	0.1%	0.1%	50.7%	-	0.3%	0%	0.1%	0%	0.3%	-	0.2%	36.9%	3.0%	0.2%	40.2%	-	4.9%	0%	3.8%	0%	8.7%	-	-
<b>PHF</b>	0.942	0.965	0.250	0.250	0.970	-	0.375	-	0.250	-	0.500	-	0.500	0.949	0.875	0.500	0.944	-	0.620	-	0.846	-	0.721	-	0.953
<b>Lights</b>	97	482	1	1	581	-	3	0	1	0	4	-	2	423	34	2	461	-	57	0	43	0	100	-	1146
<b>% Lights</b>	99.0%	98.4%	100%	100%	98.5%	-	100%	0%	100%	0%	100%	-	100%	98.6%	97.1%	100%	98.5%	-	100%	0%	97.7%	0%	99.0%	-	98.5%
<b>Articulated Trucks and Single-Unit Trucks</b>	1	1	0	0	2	-	0	0	0	0	0	-	0	0	1	0	1	-	0	0	1	0	1	-	4
<b>% Articulated Trucks and Single-Unit Trucks</b>	1.0%	0.2%	0%	0%	0.3%	-	0%	0%	0%	0%	0%	-	0%	0%	2.9%	0%	0.2%	-	0%	0%	2.3%	0%	1.0%	-	0.3%
<b>Buses</b>	0	7	0	0	7	-	0	0	0	0	0	-	0	6	0	0	6	-	0	0	0	0	0	-	13
<b>% Buses</b>	0%	1.4%	0%	0%	1.2%	-	0%	0%	0%	0%	0%	-	0%	1.4%	0%	0%	1.3%	-	0%	0%	0%	0%	0%	-	1.1%
<b>Pedestrians</b>	-	-	-	-	-	2	-	-	-	-	-	47	-	-	-	-	-	19	-	-	-	-	-	34	-
<b>% Pedestrians</b>	-	-	-	-	-	-100%	-	-	-	-	-	-97.9%	-	-	-	-	-	-100%	-	-	-	-	-	-	-89.5%
<b>Bicycles on Crosswalk</b>	-	-	-	-	-	0	-	-	-	-	-	1	-	-	-	-	-	0	-	-	-	-	-	4	-
<b>% Bicycles on Crosswalk</b>	-	-	-	-	-	0%	-	-	-	-	-	2.1%	-	-	-	-	-	0%	-	-	-	-	-	-	-10.5%

\*Pedestrians and Bicycles on Crosswalk. L: Left, R: Right, T: Thru, U: U-Turn

**Ponce De Leon Boulevard and Altara Avenue - TMC**

Tue Jan 28, 2020

PM Peak (5 PM - 6 PM) - Overall Peak Hour

All Classes (Lights, Articulated Trucks and Single-Unit Trucks, Buses, Pedestrians, Bicycles on Crosswalk)

All Movements

ID: 745284, Location: 25.733181, -80.258485, Site Code: Ponce De Leon Boulevard and Altara Avenue



Provided by: Apcte  
10305 NW 41st Street, Suite 115,  
Doral, FL, 33178, US

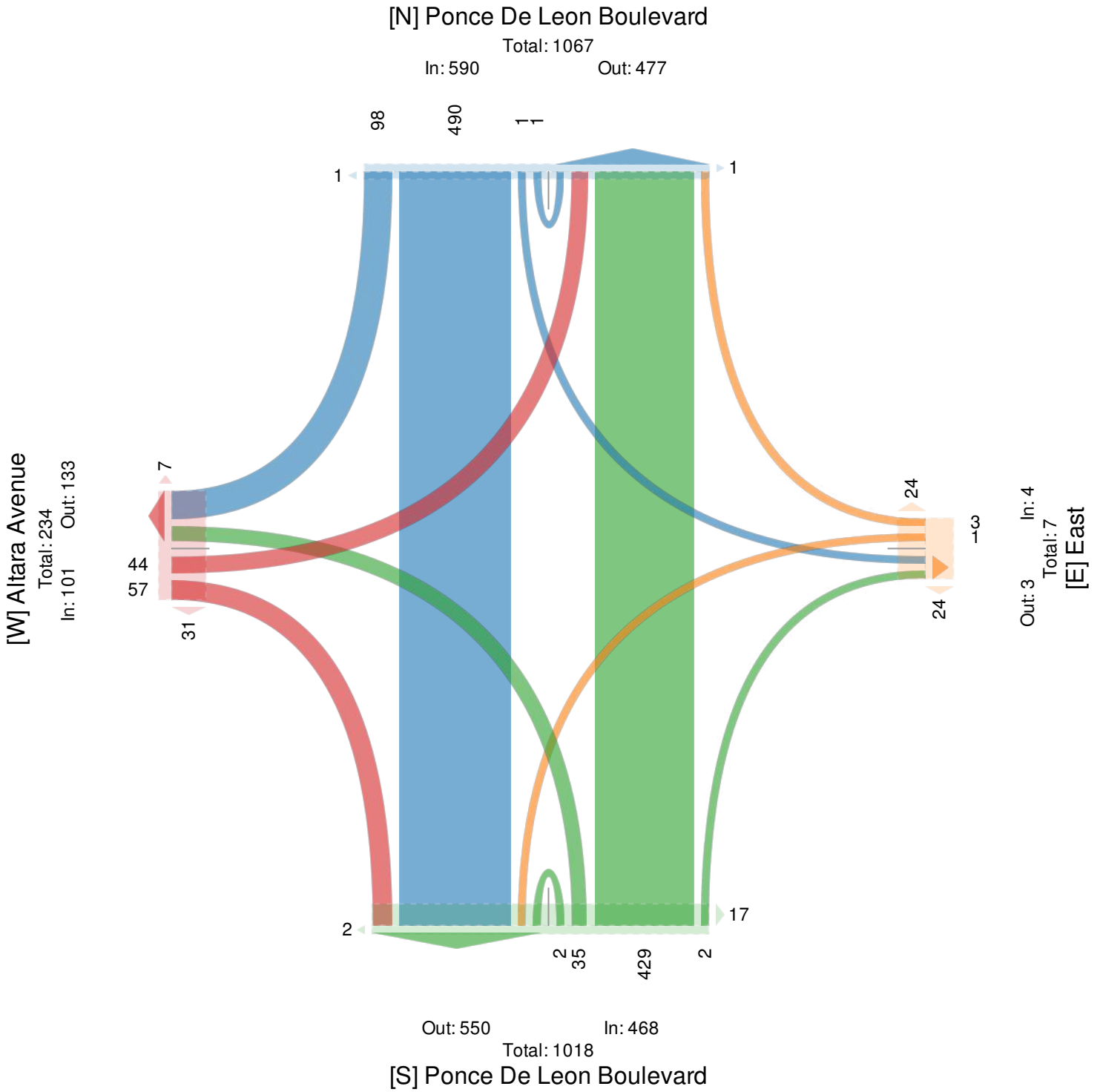

**Altara Avenue and Aurora Street - TMC**

Tue Jan 28, 2020

Full Length (7 AM-9 AM, 4 PM-6 PM)

All Classes (Lights, Articulated Trucks and Single-Unit Trucks, Buses, Pedestrians, Bicycles on Crosswalk)

All Movements

ID: 745282, Location: 25.733174, -80.259397, Site Code: Altara Avenue and Aurora Street



Provided by: Apcte

10305 NW 41st Street, Suite 115, Doral, FL, 33178, US

Leg Direction	Aurora Street Southbound						Altara Avenue Westbound						Aurora Street Northbound						Altara Avenue Eastbound						Int
Time	R	T	L	U	App	Ped*	R	T	L	U	App	Ped*	R	T	L	U	App	Ped*	R	T	L	U	App	Ped*	
2020-01-28 7:00AM	0	0	0	0	0	4	8	90	4	0	102	3	5	2	1	0	8	4	7	49	10	0	66	1	176
7:15AM	2	2	1	0	5	4	18	38	2	0	58	3	2	3	1	0	6	4	3	29	8	0	40	1	109
7:30AM	0	1	2	0	3	0	5	9	3	0	17	2	1	5	0	0	6	0	1	6	4	0	11	0	37
7:45AM	3	0	6	0	9	3	10	8	0	0	18	1	1	1	1	0	3	2	3	8	7	1	19	1	49
Hourly Total	5	3	9	0	17	11	41	145	9	0	195	9	9	11	3	0	23	10	14	92	29	1	136	3	371
8:00AM	7	0	1	0	8	4	12	18	3	0	33	2	3	0	1	0	4	2	1	6	9	0	16	0	61
8:15AM	5	1	3	0	9	0	21	16	0	0	37	0	3	2	1	0	6	1	1	9	7	0	17	0	69
8:30AM	1	0	1	0	2	2	18	24	2	0	44	0	0	1	3	0	4	0	2	11	5	0	18	0	68
8:45AM	1	2	1	0	4	2	29	16	0	0	45	2	3	3	2	0	8	2	2	6	9	0	17	0	74
Hourly Total	14	3	6	0	23	8	80	74	5	0	159	4	9	6	7	0	22	5	6	32	30	0	68	0	272
4:00PM	14	1	7	0	22	1	12	19	4	0	35	5	8	4	3	0	15	6	5	13	1	1	20	1	92
4:15PM	6	1	6	0	13	7	11	17	2	0	30	2	5	3	3	0	11	4	4	11	3	0	18	6	72
4:30PM	5	4	5	0	14	11	13	17	3	0	33	6	8	1	8	0	17	6	5	18	3	1	27	0	91
4:45PM	12	6	11	0	29	1	11	10	8	0	29	1	3	4	5	0	12	1	10	19	4	0	33	0	103
Hourly Total	37	12	29	0	78	10	47	63	17	0	127	14	24	12	19	0	55	17	24	61	11	2	98	7	358
5:00PM	25	3	19	0	47	2	10	19	4	0	33	14	6	6	5	1	18	11	11	7	3	0	21	2	119
5:15PM	13	4	5	0	22	1	9	21	4	0	34	4	6	8	7	0	21	7	9	11	5	0	25	5	102
5:30PM	18	3	11	0	32	2	8	23	3	0	34	11	7	3	2	0	12	4	10	7	7	0	24	1	102
5:45PM	28	5	8	0	41	1	9	25	2	0	36	0	3	4	6	0	13	4	10	12	4	2	28	0	118
Hourly Total	84	15	43	0	142	6	36	88	13	0	137	29	22	21	20	1	64	26	40	37	19	2	98	8	441
<b>Total</b>	<b>140</b>	<b>33</b>	<b>87</b>	<b>0</b>	<b>260</b>	<b>35</b>	<b>204</b>	<b>370</b>	<b>44</b>	<b>0</b>	<b>618</b>	<b>56</b>	<b>64</b>	<b>50</b>	<b>49</b>	<b>1</b>	<b>164</b>	<b>58</b>	<b>84</b>	<b>222</b>	<b>89</b>	<b>5</b>	<b>400</b>	<b>18</b>	<b>1442</b>
<b>% Approach</b>	53.8%	12.7%	33.5%	0%	-	-	33.0%	59.9%	7.1%	0%	-	-	39.0%	30.5%	29.9%	0.6%	-	-	21.0%	55.5%	22.3%	1.3%	-	-	-
<b>% Total</b>	9.7%	2.3%	6.0%	0%	18.0%	-	14.1%	25.7%	3.1%	0%	42.9%	-	4.4%	3.5%	3.4%	0.1%	11.4%	-	5.8%	15.4%	6.2%	0.3%	27.7%	-	-
<b>Lights</b>	139	32	86	0	257	-	199	367	42	0	608	-	63	49	49	1	162	-	82	221	88	5	396	-	1423
<b>% Lights</b>	99.3%	97.0%	98.9%	0%	98.8%	-	97.5%	99.2%	95.5%	0%	98.4%	-	98.4%	98.0%	100%	100%	98.8%	-	97.6%	99.5%	98.9%	100%	99.0%	-	98.7%
<b>Articulated Trucks and Single-Unit Trucks</b>	1	1	1	0	3	-	4	3	2	0	9	-	1	1	0	0	2	-	2	1	1	0	4	-	18
<b>% Articulated Trucks and Single-Unit Trucks</b>	0.7%	3.0%	1.1%	0%	1.2%	-	2.0%	0.8%	4.5%	0%	1.5%	-	1.6%	2.0%	0%	0%	1.2%	-	2.4%	0.5%	1.1%	0%	1.0%	-	1.2%
<b>Buses</b>	0	0	0	0	0	-	1	0	0	0	1	-	0	0	0	0	0	-	0	0	0	0	0	-	1
<b>% Buses</b>	0%	0%	0%	0%	0%	-	0.5%	0%	0%	0%	0.2%	-	0%	0%	0%	0%	0%	-	0%	0%	0%	0%	0%	-	0.1%
<b>Pedestrians</b>	-	-	-	-	-	35	-	-	-	-	-	56	-	-	-	-	-	58	-	-	-	-	-	18	-
<b>% Pedestrians</b>	-	-	-	-	-	100%	-	-	-	-	-	100%	-	-	-	-	-	100%	-	-	-	-	-	100%	-
<b>Bicycles on Crosswalk</b>	-	-	-	-	-	0	-	-	-	-	-	0	-	-	-	-	-	0	-	-	-	-	-	0	-
<b>% Bicycles on Crosswalk</b>	-	-	-	-	-	0%	-	-	-	-	-	0%	-	-	-	-	-	0%	-	-	-	-	-	0%	-

\* Pedestrians and Bicycles on Crosswalk. L: Left, R: Right, T: Thru, U: U-Turn

**Altara Avenue and Aurora Street - TMC**

Tue Jan 28, 2020

Full Length (7 AM-9 AM, 4 PM-6 PM)

All Classes (Lights, Articulated Trucks and Single-Unit Trucks, Buses, Pedestrians, Bicycles on Crosswalk)

All Movements

ID: 745282, Location: 25.733174, -80.259397, Site Code: Altara Avenue and Aurora Street



Provided by: Apcte  
10305 NW 41st Street, Suite 115,  
Doral, FL, 33178, US

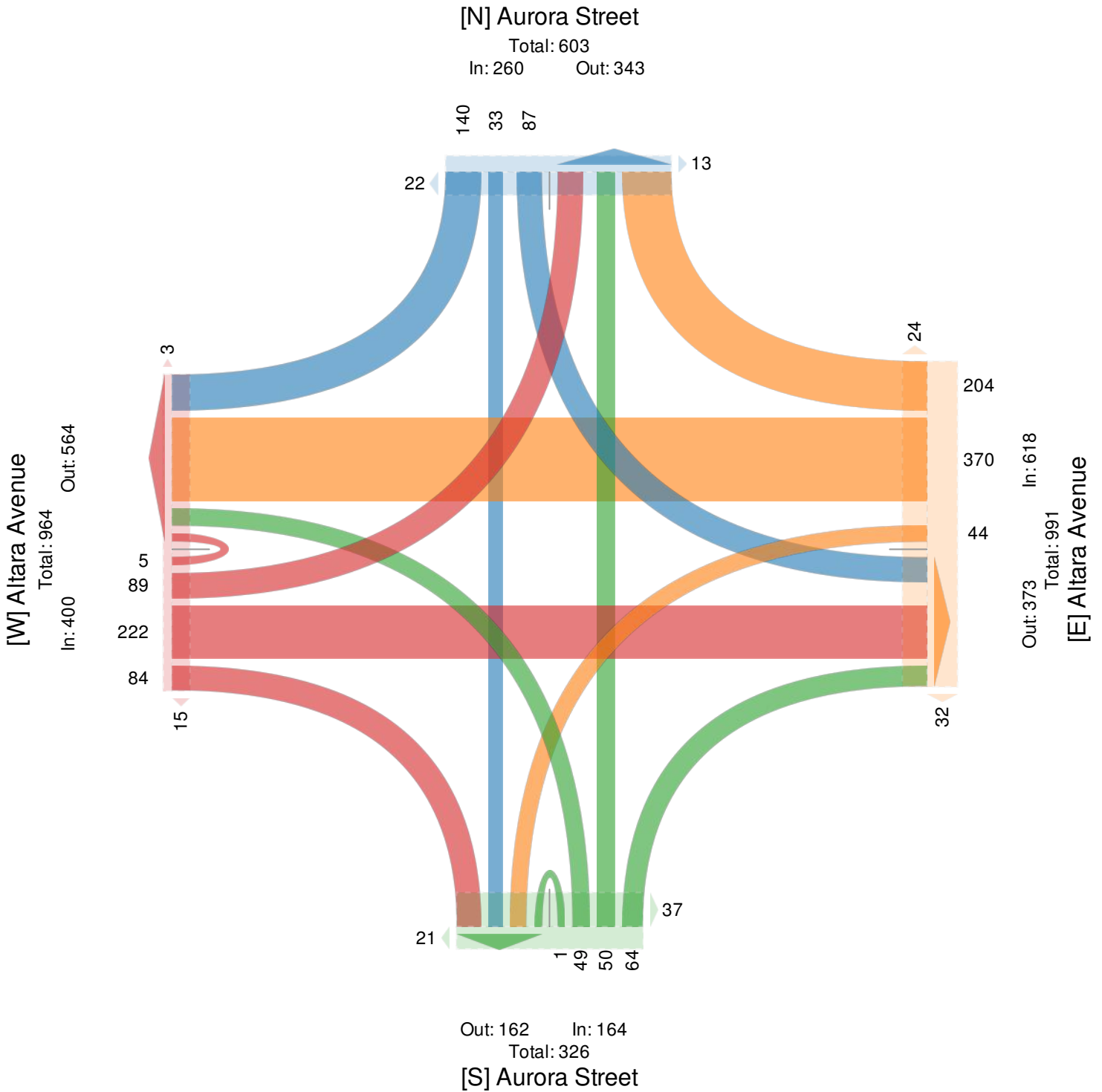

**Altara Avenue and Aurora Street - TMC**

Tue Jan 28, 2020

AM Peak (7 AM - 8 AM)

All Classes (Lights, Articulated Trucks and Single-Unit Trucks, Buses, Pedestrians, Bicycles on Crosswalk)

All Movements

ID: 745282, Location: 25.733174, -80.259397, Site Code: Altara Avenue and Aurora Street



Provided by: Apcte  
10305 NW 41st Street, Suite 115,  
Doral, FL, 33178, US

Leg Direction	Aurora Street Southbound						Altara Avenue Westbound						Aurora Street Northbound						Altara Avenue Eastbound						
Time	R	T	L	U	App	Ped*	R	T	L	U	App	Ped*	R	T	L	U	App	Ped*	R	T	L	U	App	Ped*	Int
2020-01-28 7:00AM	0	0	0	0	0	4	8	90	4	0	102	3	5	2	1	0	8	4	7	49	10	0	66	1	176
7:15AM	2	2	1	0	5	4	18	38	2	0	58	3	2	3	1	0	6	4	3	29	8	0	40	1	109
7:30AM	0	1	2	0	3	0	5	9	3	0	17	2	1	5	0	0	6	0	1	6	4	0	11	0	37
7:45AM	3	0	6	0	9	3	10	8	0	0	18	1	1	1	1	0	3	2	3	8	7	1	19	1	49
<b>Total</b>	5	3	9	0	17	11	41	145	9	0	195	9	9	11	3	0	23	10	14	92	29	1	136	3	371
<b>% Approach</b>	29.4%	17.6%	52.9%	0%	-	-	21.0%	74.4%	4.6%	0%	-	-	39.1%	47.8%	13.0%	0%	-	-	10.3%	67.6%	21.3%	0.7%	-	-	-
<b>% Total</b>	1.3%	0.8%	2.4%	0%	4.6%	-	11.1%	39.1%	2.4%	0%	52.6%	-	2.4%	3.0%	0.8%	0%	6.2%	-	3.8%	24.8%	7.8%	0.3%	36.7%	-	-
<b>PHF</b>	0.417	0.375	0.375	-	0.472	-	0.569	0.403	0.563	-	0.478	-	0.450	0.550	0.750	-	0.719	-	0.500	0.469	0.725	0.250	0.515	-	0.527
<b>Lights</b>	5	2	9	0	16	-	41	143	8	0	192	-	9	11	3	0	23	-	14	92	28	1	135	-	366
<b>% Lights</b>	100%	66.7%	100%	0%	94.1%	-	100%	98.6%	88.9%	0%	98.5%	-	100%	100%	100%	0%	100%	-	100%	100%	96.6%	100%	99.3%	-	98.7%
<b>Articulated Trucks and Single-Unit Trucks</b>	0	1	0	0	1	-	0	2	1	0	3	-	0	0	0	0	0	-	0	0	1	0	1	-	5
<b>% Articulated Trucks and Single-Unit Trucks</b>	0%	33.3%	0%	0%	5.9%	-	0%	1.4%	11.1%	0%	1.5%	-	0%	0%	0%	0%	0%	-	0%	0%	3.4%	0%	0.7%	-	1.3%
<b>Buses</b>	0	0	0	0	0	-	0	0	0	0	0	-	0	0	0	0	0	-	0	0	0	0	0	-	0
<b>% Buses</b>	0%	0%	0%	0%	0%	-	0%	0%	0%	0%	0%	-	0%	0%	0%	0%	0%	-	0%	0%	0%	0%	0%	-	0%
Pedestrians	-	-	-	-	-	11	-	-	-	-	-	9	-	-	-	-	-	10	-	-	-	-	-	3	-
<b>% Pedestrians</b>	-	-	-	-	-	100%	-	-	-	-	-	100%	-	-	-	-	-	100%	-	-	-	-	-	100%	-
Bicycles on Crosswalk	-	-	-	-	-	0	-	-	-	-	-	0	-	-	-	-	-	0	-	-	-	-	-	0	-
<b>% Bicycles on Crosswalk</b>	-	-	-	-	-	0%	-	-	-	-	-	0%	-	-	-	-	-	0%	-	-	-	-	-	0%	-

\*Pedestrians and Bicycles on Crosswalk. L: Left, R: Right, T: Thru, U: U-Turn

**Altara Avenue and Aurora Street - TMC**

Tue Jan 28, 2020

AM Peak (7 AM - 8 AM)

All Classes (Lights, Articulated Trucks and Single-Unit Trucks, Buses, Pedestrians, Bicycles on Crosswalk)

All Movements

ID: 745282, Location: 25.733174, -80.259397, Site Code: Altara Avenue and Aurora Street



Provided by: Apcte  
10305 NW 41st Street, Suite 115,  
Doral, FL, 33178, US

**[N] Aurora Street**

Total: 98  
In: 17 Out: 81

530

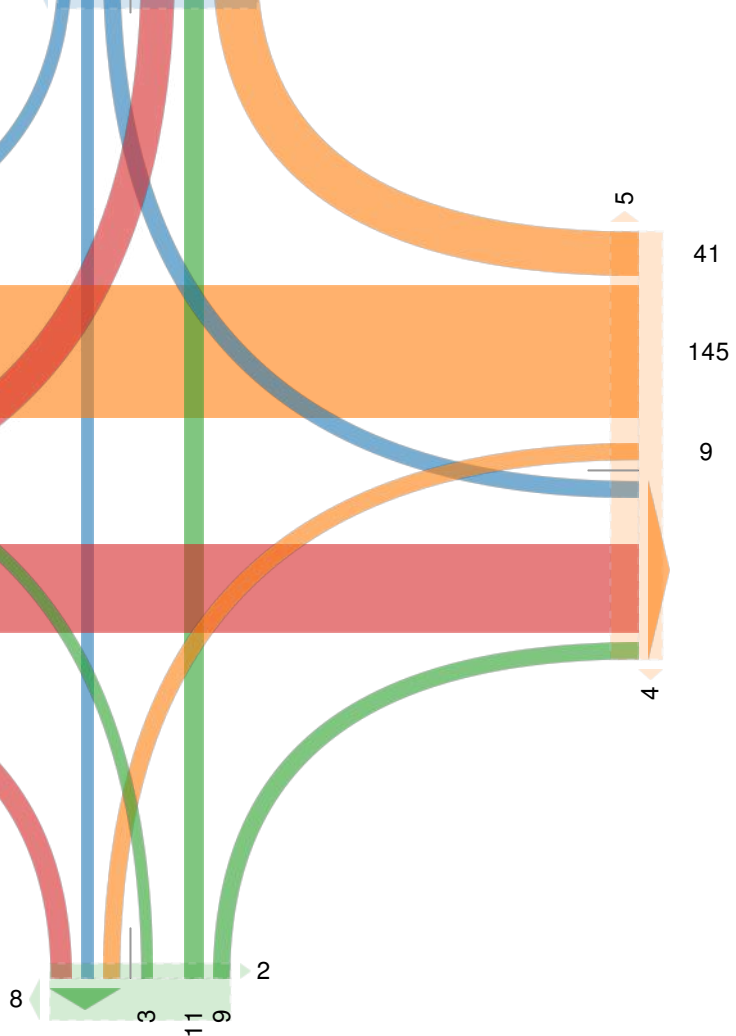

**[W] Altara Avenue**

Total: 290  
In: 136 Out: 154

1  
29  
92  
14

3



Out: 26 In: 23  
Total: 49

**[S] Aurora Street**

Out: 110 In: 195  
Total: 305

**[E] Altara Avenue**

41  
145  
9

5

4

**Altara Avenue and Aurora Street - TMC**

Tue Jan 28, 2020

PM Peak (5 PM - 6 PM) - Overall Peak Hour

All Classes (Lights, Articulated Trucks and Single-Unit Trucks, Buses, Pedestrians, Bicycles on Crosswalk)

All Movements

ID: 745282, Location: 25.733174, -80.259397, Site Code: Altara Avenue and Aurora Street



Provided by: Apcte  
10305 NW 41st Street, Suite 115,  
Doral, FL, 33178, US

Leg Direction	Aurora Street Southbound						Altara Avenue Westbound						Aurora Street Northbound						Altara Avenue Eastbound						Int
	R	T	L	U	App	Ped*	R	T	L	U	App	Ped*	R	T	L	U	App	Ped*	R	T	L	U	App	Ped*	
2020-01-28 5:00PM	25	3	19	0	47	2	10	19	4	0	33	14	6	6	5	1	18	11	11	7	3	0	21	2	119
5:15PM	13	4	5	0	22	1	9	21	4	0	34	4	6	8	7	0	21	7	9	11	5	0	25	5	102
5:30PM	18	3	11	0	32	2	8	23	3	0	34	11	7	3	2	0	12	4	10	7	7	0	24	1	102
5:45PM	28	5	8	0	41	1	9	25	2	0	36	0	3	4	6	0	13	4	10	12	4	2	28	0	118
<b>Total</b>	84	15	43	0	142	6	36	88	13	0	137	29	22	21	20	1	64	26	40	37	19	2	98	8	441
<b>% Approach</b>	59.2%	10.6%	30.3%	0%	-	-	26.3%	64.2%	9.5%	0%	-	-	34.4%	32.8%	31.3%	1.6%	-	-	40.8%	37.8%	19.4%	2.0%	-	-	-
<b>% Total</b>	19.0%	3.4%	9.8%	0%	32.2%	-	8.2%	20.0%	2.9%	0%	31.1%	-	5.0%	4.8%	4.5%	0.2%	14.5%	-	9.1%	8.4%	4.3%	0.5%	22.2%	-	-
<b>PHF</b>	0.750	0.750	0.566	-	0.755	-	0.900	0.880	0.813	-	0.951	-	0.786	0.656	0.714	0.250	0.762	-	0.909	0.771	0.679	0.250	0.875	-	0.926
<b>Lights</b>	83	15	43	0	141	-	34	88	13	0	135	-	22	21	20	1	64	-	40	37	19	2	98	-	438
<b>% Lights</b>	98.8%	100%	100%	0%	99.3%	-	94.4%	100%	100%	0%	98.5%	-	100%	100%	100%	100%	100%	-	100%	100%	100%	100%	100%	-	99.3%
<b>Articulated Trucks and Single-Unit Trucks</b>	1	0	0	0	1	-	1	0	0	0	1	-	0	0	0	0	0	-	0	0	0	0	0	-	2
<b>% Articulated Trucks and Single-Unit Trucks</b>	1.2%	0%	0%	0%	0.7%	-	2.8%	0%	0%	0%	0.7%	-	0%	0%	0%	0%	0%	-	0%	0%	0%	0%	0%	-	0.5%
<b>Buses</b>	0	0	0	0	0	-	1	0	0	0	1	-	0	0	0	0	0	-	0	0	0	0	0	-	1
<b>% Buses</b>	0%	0%	0%	0%	0%	-	2.8%	0%	0%	0%	0.7%	-	0%	0%	0%	0%	0%	-	0%	0%	0%	0%	0%	-	0.2%
<b>Pedestrians</b>	-	-	-	-	-	6	-	-	-	-	-	29	-	-	-	-	-	26	-	-	-	-	-	8	
<b>% Pedestrians</b>	-	-	-	-	-	100%	-	-	-	-	-	100%	-	-	-	-	-	100%	-	-	-	-	-	100%	
<b>Bicycles on Crosswalk</b>	-	-	-	-	-	0	-	-	-	-	-	0	-	-	-	-	-	0	-	-	-	-	-	0	
<b>% Bicycles on Crosswalk</b>	-	-	-	-	-	0%	-	-	-	-	-	0%	-	-	-	-	-	0%	-	-	-	-	-	0%	

\* Pedestrians and Bicycles on Crosswalk. L: Left, R: Right, T: Thru, U: U-Turn

**Altara Avenue and Aurora Street - TMC**

Tue Jan 28, 2020

PM Peak (5 PM - 6 PM) - Overall Peak Hour

All Classes (Lights, Articulated Trucks and Single-Unit Trucks, Buses, Pedestrians, Bicycles on Crosswalk)

All Movements

ID: 745282, Location: 25.733174, -80.259397, Site Code: Altara Avenue and Aurora Street



Provided by: Apcte  
10305 NW 41st Street, Suite 115,  
Doral, FL, 33178, US

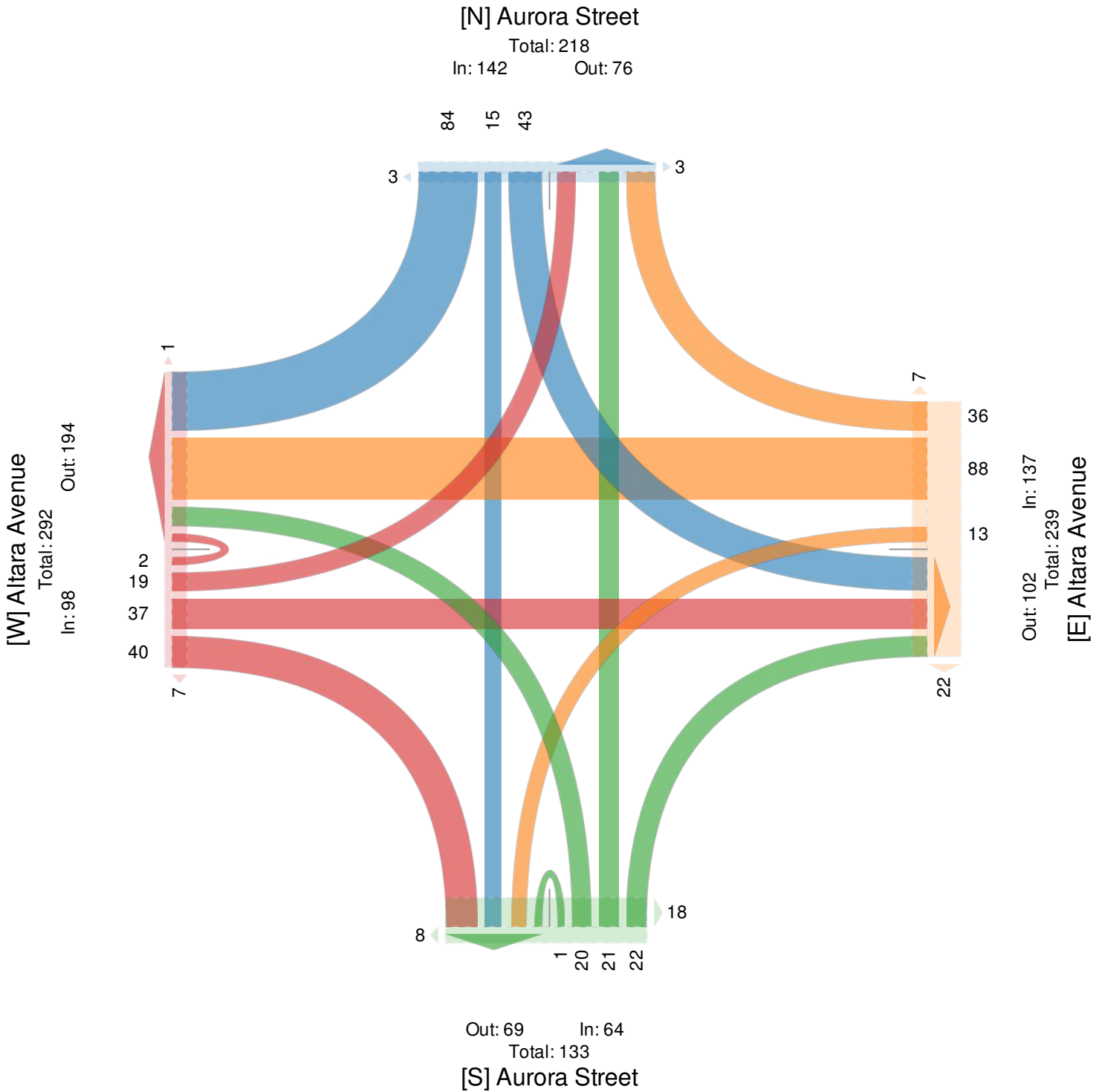



# APPENDIX C

---

## Peak Season Factor Category Report

2018 PEAK SEASON FACTOR CATEGORY REPORT - REPORT TYPE: COUNTY  
 CATEGORY: 8701 MIAMI-DADE SOUTH

MOCF: 0.96

WEEK	DATES	SF	PSCF
1	01/01/2018 - 01/06/2018	1.01	1.05
2	01/07/2018 - 01/13/2018	1.01	1.05
3	01/14/2018 - 01/20/2018	1.00	1.04
4	01/21/2018 - 01/27/2018	0.99	1.03
* 5	01/28/2018 - 02/03/2018	0.98	1.02
* 6	02/04/2018 - 02/10/2018	0.97	1.01
* 7	02/11/2018 - 02/17/2018	0.96	1.00
* 8	02/18/2018 - 02/24/2018	0.96	1.00
* 9	02/25/2018 - 03/03/2018	0.96	1.00
*10	03/04/2018 - 03/10/2018	0.96	1.00
*11	03/11/2018 - 03/17/2018	0.96	1.00
*12	03/18/2018 - 03/24/2018	0.96	1.00
*13	03/25/2018 - 03/31/2018	0.96	1.00
*14	04/01/2018 - 04/07/2018	0.96	1.00
*15	04/08/2018 - 04/14/2018	0.96	1.00
*16	04/15/2018 - 04/21/2018	0.96	1.00
*17	04/22/2018 - 04/28/2018	0.98	1.02
18	04/29/2018 - 05/05/2018	0.99	1.03
19	05/06/2018 - 05/12/2018	1.01	1.05
20	05/13/2018 - 05/19/2018	1.02	1.06
21	05/20/2018 - 05/26/2018	1.03	1.07
22	05/27/2018 - 06/02/2018	1.03	1.07
23	06/03/2018 - 06/09/2018	1.04	1.08
24	06/10/2018 - 06/16/2018	1.04	1.08
25	06/17/2018 - 06/23/2018	1.04	1.08
26	06/24/2018 - 06/30/2018	1.04	1.08
27	07/01/2018 - 07/07/2018	1.05	1.09
28	07/08/2018 - 07/14/2018	1.05	1.09
29	07/15/2018 - 07/21/2018	1.05	1.09
30	07/22/2018 - 07/28/2018	1.04	1.08
31	07/29/2018 - 08/04/2018	1.03	1.07
32	08/05/2018 - 08/11/2018	1.02	1.06
33	08/12/2018 - 08/18/2018	1.01	1.05
34	08/19/2018 - 08/25/2018	1.01	1.05
35	08/26/2018 - 09/01/2018	1.02	1.06
36	09/02/2018 - 09/08/2018	1.02	1.06
37	09/09/2018 - 09/15/2018	1.02	1.06
38	09/16/2018 - 09/22/2018	1.01	1.05
39	09/23/2018 - 09/29/2018	1.01	1.05
40	09/30/2018 - 10/06/2018	1.00	1.04
41	10/07/2018 - 10/13/2018	1.00	1.04
42	10/14/2018 - 10/20/2018	0.99	1.03
43	10/21/2018 - 10/27/2018	1.00	1.04
44	10/28/2018 - 11/03/2018	1.00	1.04
45	11/04/2018 - 11/10/2018	1.01	1.05
46	11/11/2018 - 11/17/2018	1.01	1.05
47	11/18/2018 - 11/24/2018	1.01	1.05
48	11/25/2018 - 12/01/2018	1.01	1.05
49	12/02/2018 - 12/08/2018	1.01	1.05
50	12/09/2018 - 12/15/2018	1.01	1.05
51	12/16/2018 - 12/22/2018	1.01	1.05
52	12/23/2018 - 12/29/2018	1.00	1.04
53	12/30/2018 - 12/31/2018	1.00	1.04

\* PEAK SEASON

28-FEB-2019 15:24:23

830UPD

6\_8701\_PKSEASON.TXT

# APPENDIX D

---

## Signal Timing Data

Timing Phases	Direction	WB		EB			NB		SB		Ped Heads				Movements/Display/Actuation	
		Head No.	2	5/2	6	1/6	6R	4	7/4	8R	3/8	P2	P4	P6		P8
(1+5) EBLT/WBLT BIRD RD <b>ACTUATED</b>	Dwell	R	<G/R	R	<G/R	R	R	R	R/G>	R	DW	DW	DW	DW		
	Clear to	2+5	R	<G/G	R	<Y/R	R	R	R	R/Y>	R	DW	DW	DW		DW
		1+6	R	<Y/R	R	<G/G	R	R	R	R/G>	R	DW	DW	DW		DW
		2+6	R	<Y/R	R	<Y/R	R	R	R	R/Y>	R	DW	DW	DW		DW
(2+5) WBLT+WBT BIRD RD <b>ACTUATED</b>	Dwell	G	<G/G	R	R	R	R	R	R	R	WF	DW	DW	DW		
	Clear to	2+6	G	<Y/G	R	R	R	R	R	R	WF	DW	DW	DW		
(1+6) EBLT/EBT BIRD RD <b>ACTUATED</b>	Dwell	R	R	G	<G/G	R	R	R	R/G>	R	DW	DW	WF	DW		
	Clear to	2+6	R	R	Y	<Y/G	R	R	R	R/Y>	R	DW	DW	WF		DW
(2+6) SBT/NBT NW 7 AV <b>RECALL</b>	Dwell	G	G	G	R	R	R	R	R	R	W/F	DW	W/F	DW		
	Clear to	1+5	Y	Y	Y	R	R	R	R	R	R	DW	DW	DW		DW
		2+5	Y	Y	Y	R	R	R	R	R	R	DW	DW	DW		DW
		1+6	Y	Y	Y	R	R	R	R	R	R	DW	DW	DW		DW
		3+7	Y	Y	Y	R	R	R	R	R	R	DW	DW	DW		DW
		4+8	Y	Y	Y	R	R	R	R	R	R	DW	DW	DW		DW
(3+7) SBLT/NBLT	Dwell	R	R	R	R	R/G>	R	<G/R	R	<G/R	DW	DW	DW	DW		
	Clear to	3+8	R	R	R	R	R/Y>	R	<Y/R	R	<G/G	DW	DW	DW		DW
		4+7	R	R	R	R	R/G>	R	<G/G	R	<Y/R	DW	DW	DW		DW
		4+8	R	R	R	R	R/Y>	R	<Y/R	R	<Y/R	DW	DW	DW		DW
		1+5	R	R	R	R	R/Y>	R	<Y/R	R	<Y/R	DW	DW	DW		DW
		2+5	R	R	R	R	R/Y>	R	<Y/R	R	<Y/R	DW	DW	DW		DW
		2+6	R	R	R	R	R/Y>	R	<Y/R	R	<Y/R	DW	DW	DW		DW
Flashing Operation		FY	FY	FY	FY	FY	FR	FR	FR	FR					Page 1 of 2	
<b>MIAMI-DADE COUNTY PUBLIC WORK DEPARTMENT</b>																
Drawn Mario L. Hernandez		Date 5/5/2010		<b>Bird Rd &amp; Ponce de Leon Blvd</b>												
Checked H. Hernandez	Date 11/18/10	Placed in Service				Phasing No.				Asset Number						
		Date 12-22-2010				By SUU				8				2594		

# SIGNAL OPERATING PLAN



Timing Phases	Direction	WB		EB			NB		SB		Ped Heads				Movements/Display/Actuation	
	Head No.	2	5/2	6	1/6	6R	4	7/4	8R	3/8	P2	P4	P6	P8		
<b>(3 + 8)</b> SBLT/SBT PONCE DE LEON	Dwell	R	R	R	R	R	R	R	R	<G/G	DW	DW	DW	W/F		
	Clear to	4+8	R	R	R	R	R	R	R	R	<Y/G	DW	DW	DW		W/F
		1+5	R	R	R	R	R	R	R	R	<Y/Y	DW	DW	DW		DW
		1+6	R	R	R	R	R	R	R	R	<Y/Y	DW	DW	DW		DW
		2+5	R	R	R	R	R	R	R	R	<Y/Y	DW	DW	DW		DW
		2+6	R	R	R	R	R	R	R	R	<Y/Y	DW	DW	DW		DW
<b>ACTUATED</b>																
<b>(4 + 7)</b> NBLT/NBT PONCE DE LEON	Dwell	R	R	R	R	R/G>	G	<G/G	R	R	DW	W/F	DW	DW		
	Clear to	4+8	R	R	R	R	R/Y>	G	<Y/G	R	R	DW	W/F	DW		DW
		1+5	R	R	R	R	R	Y	<Y/Y	R	R	DW	DW	DW		DW
		1+6	R	R	R	R	R	Y	<Y/Y	R	R	DW	DW	DW		DW
		2+5	R	R	R	R	R	Y	<Y/Y	R	R	DW	DW	DW		DW
		2+6	R	R	R	R	R	Y	<Y/Y	R	R	DW	DW	DW		DW
<b>ACTUATED</b>																
<b>(4 + 8)</b> NBT/SBT PONCE DE LEON	Dwell	R	R	R	R	R	G	G	R	G	DW	WF	DW	WF		
	Clear to	1+5	R	R	R	R	R	Y	Y	R	Y	DW	DW	DW		DW
		1+6	R	R	R	R	R	Y	Y	R	Y	DW	DW	DW		DW
		2+5	R	R	R	R	R	Y	Y	R	Y	DW	DW	DW		DW
		2+6	R	R	R	R	R	Y	Y	R	Y	DW	DW	DW		DW
<b>ACTUATED</b>																
	Dwell															
	Clear to															
	Dwell															
	Clear to															
	Dwell															
	Clear to															

**MIAMI-DADE COUNTY PUBLIC WORK DEPARTMENT**

Flashing Operation	FY	FY	FY	FY	FR	FR	FR	FR						
Drawn Mario L. Hernandez	Date 5/5/2010	Bird Rd & Ponce de Leon Blvd												
Checked H. Hernandez	Date 11/18/10	Placed in Service Date 12-22-2010				By SUU		Phasing No. 8			Asset Number 2594			

GridPPConcPeds

EXISTING SIGNAL HEAD DETAILS:

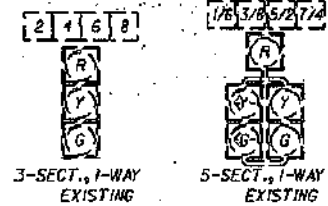

SIGNAL HEAD DETAILS:

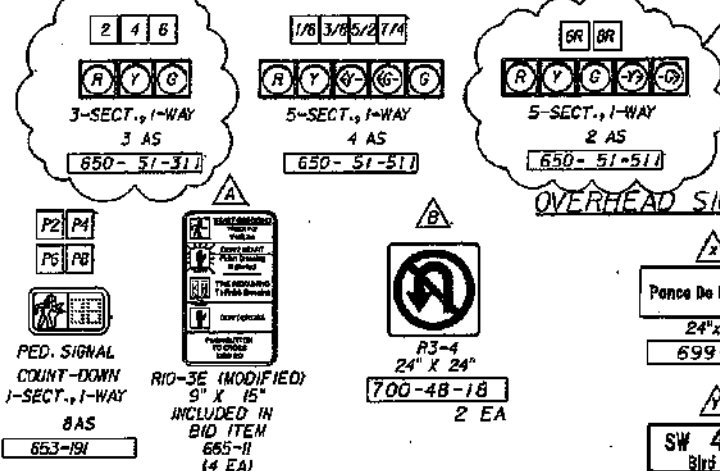

OVERHEAD SIGN DETAILS:

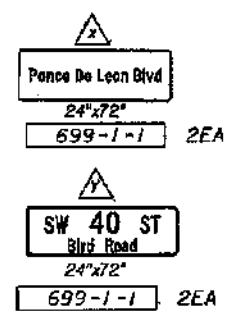

SIGNAL OPERATION NOTES:

- THE MAJOR STREET IS SW 40 STREET AND THE MINOR STREET IS PONCE DE LEON
- SIGNAL OPERATION PLAN S.O.P. 10
  - (A) FLASHING OPERATION IS YELLOW FOR MOVEMENTS 2 & 6 AND RED FOR MOVEMENTS 4 & 8
  - (B) SIGNAL TIMINGS ARE TO BE PROVIDED BY MIAMI-DADE COUNTY SIGNAL DIVISION.
- STATIONS AND OFFSETS ARE MEASURED FROM THE BASELINE SURVEY FOR SW 40 STREET
  - PAY ITEM 660-1-109 INCLUDES ONE LOOP DETECTOR AS CONTINGENCY TO BE USED IN CASE ANY EXISTING LOOP DETECTOR IS DAMAGED AND THAT WILL BE INSTALLED AS DIRECTED BY THE ENGINEER.

POLE LOCATIONS

- 6 STA. 421+24.61 @ SURVEY SW 40 ST (29.41'LT), ARM BEARING S 3° 31' 20" E
- 7 STA. 422+29.90 @ SURVEY SW 40 ST (45.10'LT), ARM BEARING S 87° 59' 25" W
- 8 STA. 422+26.09 @ SURVEY SW 40 ST (68.20'RT), ARM BEARING N 3° 4' 35" W
- 9 STA. 421+45.00 @ SURVEY SW 40 ST (80.50'RT), ARM BEARING N 87° 11' 53" E

PEDESTAL LOCATION

- 9 STA. 421+34.98 @ SURVEY SW 40 ST (39.57'LT)
- 10 STA. 422+40.46 @ SURVEY SW 40 ST (29.49'LT)
- 11 STA. 422+38.10 @ SURVEY SW 40 ST (54.26'RT)
- 12 STA. 421+28.60 @ SURVEY SW 40 ST (67.09'RT)

DETECTORS FOR LOOPS

LOOP	NO. OF LOOPS	NO. OF NEW DETS.
L-1	1	
L-3	1	
L-4	2	
L-5	1	
L-7	1	
L-8	3	

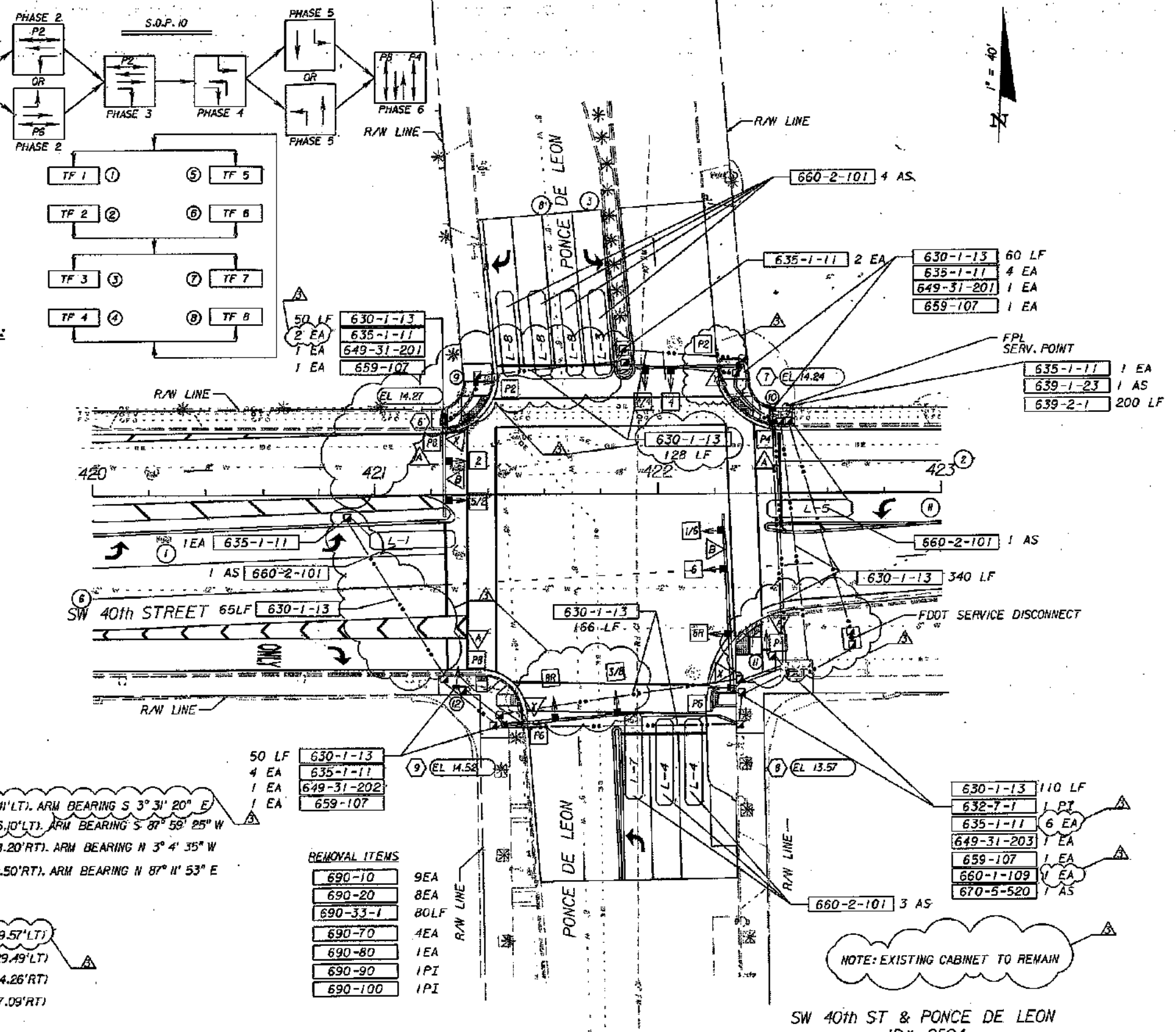

- 50 LF 630-1-13  
4 EA 635-1-11  
1 EA 649-31-202  
1 EA 659-107

- REMOVAL ITEMS
- 690-10 9EA
  - 690-20 8EA
  - 690-33-1 80LF
  - 690-70 4EA
  - 690-80 1EA
  - 690-90 1PI
  - 690-100 1PI

REVISIONS					
DATE	BY	DESCRIPTION	DATE	BY	DESCRIPTION
4/2/10	J.L.	SIGNALIZATION CHANGES. NOTE WAS ADDED.			

PABLO BIELECKI  
P.E. LICENSE NO. 53061

**Gannett Fleming**

7300 CORPORATE CENTER DRIVE, SUITE 701  
MIAMI, FLORIDA 33126  
(786) 845-9540 FAX (786) 845-6802  
CERTIFICATE OF AUTHORIZATION NO. 5564



STATE OF FLORIDA DEPARTMENT OF TRANSPORTATION		
ROAD NO.	COUNTY	FINANCIAL PROJECT ID
976	MIAMI-DADE	418093-1-52-01

**SIGNALIZATION PLANS**

SHEET NO. T-9

NOT BE: THE OFFICIAL RECORD OF THIS SHEET IS THE ELECTRONIC FILE SIGNED AND SEALED UNDER RULE 6815-23.003, F.A.C.









**TOD Schedule Report**  
for 2594: Bird Rd&Ponce De Leon Blvd

Print Date:  
2/24/2020

Print Time:  
12:06 PM

<u>Asset</u>	<u>Intersection</u>	<u>TOD Schedule</u>	<u>Op Mode</u>	<u>Plan #</u>	<u>Cycle</u>	<u>Offset</u>	<u>TOD Setting</u>	<u>Active PhaseBank</u>	<u>Active Maximum</u>
2594	Bird Rd&Ponce De Leon Blvd	DOW-2	TOD	[06] MID-MORNING	150	71	N/A	1	Max 2

**Splits**

<u>PH 1</u>	<u>PH 2</u>	<u>PH 3</u>	<u>PH 4</u>	<u>PH 5</u>	<u>PH 6</u>	<u>PH 7</u>	<u>PH 8</u>
EBL	WBT	SBL	NBT	WBL	EBT	NBL	SBT
8	83	10	23	8	83	10	23
							

Active Phase Bank: Phase Bank 1

<u>Phase</u>	<u>Walk</u>			<u>Don't Walk</u>			<u>Min Initial</u>			<u>Veh Ext</u>			<u>Max Limit</u>			<u>Max 2</u>			<u>Yellow</u>	<u>Red</u>
	1	2	3	1	2	3	1	2	3	1	2	3	1	2	3	1	2	3		
1 EBL	0	0	0	0	0	0	5	5	5	3.5	2	2	6	6	6	22	20	11	4	2.3
2 WBT	7	7	7	26	26	26	7	7	7	1	1	1	27	27	27	0	80	80	4	2.3
3 SBL	0	0	0	0	0	0	5	5	5	3	2	2	6	6	6	15	13	9	3.7	3.1
4 NBT	5	5	5	26	26	26	7	7	7	3.5	2.5	2.5	25	25	25	43	30	28	4	3.1
5 WBL	0	0	0	0	0	0	5	5	5	3	2	2	6	6	6	16	13	11	4	2.3
6 EBT	7	7	7	26	26	26	7	7	7	1	1	1	27	27	27	0	80	80	4	2.3
7 NBL	0	0	0	0	0	0	5	5	5	3	2	2	6	6	6	15	13	9	3.7	3.1
8 SBT	5	5	5	26	26	26	7	7	7	3.5	2.5	2.5	25	25	25	43	30	28	4	3.1

Last In Service Date: unknown

<b>Permitted Phases</b>	
	<b>12345678</b>
Default	12345678
External Permit 0	-----
External Permit 1	1234-678
External Permit 2	-2-4-6-8

**TOD Schedule Report**  
for 2594: Bird Rd&Ponce De Leon Blvd

Print Date:  
2/24/2020

Print Time:  
12:06 PM

Current TOD Schedule	Plan	Cycle	Green Time								Ring Offset	Offset
			1 EBL	2 WBT	3 SBL	4 NBT	5 WBL	6 EBT	7 NBL	8 SBT		
	Free											
0130	Free											
0500	Free											
0530	5	140	4	86	6	18	4	86	6	18	0	108
0600	11	180	20	84	13	37	13	91	13	37	0	141
1030	6	150	8	83	10	23	8	83	10	23	0	71
1500	13	180	6	107	10	31	13	100	6	35	0	58
2000	6	150	8	83	10	23	8	83	10	23	0	71
2100	9	100	6	41	10	17	6	41	10	17	0	57
	1	140	10	71	8	25	10	71	8	25	0	38
	2	100	5	41	7	21	5	41	7	21	0	24
	3	120	9	57	7	21	9	57	7	21	0	62
	4	130	9	64	7	24	9	64	7	24	0	38
	7	140	7	77	9	21	7	77	9	21	0	58
	8	120	6	64	7	17	6	64	7	17	0	2
	10	110	5	58	6	15	5	58	6	15	0	76
	12	130	6	72	8	18	6	72	8	18	0	64
	15	140	7	77	9	21	7	77	9	21	0	112
	16	120	6	64	7	17	6	64	7	17	0	8
	17	120	6	61	6	21	6	61	6	21	0	92
	18	110	6	56	7	15	6	56	7	15	0	26
	21	80	4	24	5	21	4	24	5	21	0	18

Local TOD Schedule			
Time	Plan	DOW	
0000	21	Su	S
0000	Free	M T W Th F	
0115	Free	Su	S
0130	Free	M T W Th F	
0230	Free	Su	S
0500	Free	M T W Th F	
0530	5	M T W Th F	
0600	11	M T W Th F	
0600	6	Su	S
1030	6	M T W Th F	
1500	13	M T W Th F	
2000	6	M T W Th F	
2100	9	M T W Th F	
2300	21	Su	S

Current Time of Day Function			
Time	Function	Settings *	Day of Week
0000	TOD OUTPUTS	-----	SuM T W ThF S
0500	TOD OUTPUTS	---5---1	M T W ThF
0700	TOD OUTPUTS	-----	M T W ThF

Local Time of Day Function			
Time	Function	Settings *	Day of Week
0000	TOD OUTPUTS	-----	SuM T W ThF S
0500	TOD OUTPUTS	---5---1	M T W ThF
0700	TOD OUTPUTS	-----	M T W ThF

- \* Settings**
- Blank - FREE - Phase Bank 1, Max 1
  - Blank - Plan - Phase Bank 1, Max 2
  - 1 - Phase Bank 2, Max 1
  - 2 - Phase Bank 2, Max 2
  - 3 - Phase Bank 3, Max 1
  - 4 - Phase Bank 3, Max 2
  - 5 - EXTERNAL PERMIT 1
  - 6 - EXTERNAL PERMIT 2
  - 7 - X-PED OMIT
  - 8 - TBA



**TOD Schedule Report**

**for 2594: Bird Rd&Ponce De Leon Blvd**

Print Date:

**2/24/2020**

Print Time:

**12:06 PM**

***No Calendar Defined/Enabled***

# SIGNAL OPERATING PLAN



Timing Phases	Direction	EB		WB		SB		NB		Ped Heads				Movements/Display/Activation
		Head No.	1/6	6	5/2	2	3/8	8	7/4	4	P6	P2	P8	
(1+5) <b>ACTUATED</b>	Dwell	<G/R	R	<G/R	R	R	R	R	R	DW	DW	DW	DW	
	Cleare 1 (1+6)	<G/R	R	<Y/R	R	R	R	R	R	DW	DW	DW	DW	
	Cleare 2 (2+5)	<Y/R	R	<G/R	R	R	R	R	R	DW	DW	DW	DW	
	Cleare 3 (2+6)	<Y/R	R	<Y/R	R	R	R	R	R	DW	DW	DW	DW	
(1+6) <b>(ACTUATED)</b>	Dwell	<G/G	G	R	R	R	R	R	R	W/F	DW	DW	DW	
	Cleare (2+6)	<Y/G	G	R	R	R	R	R	R	DW	DW	DW	DW	
(2+5) <b>(ACTUATED)</b>	Dwell	R	R	<G/G	G	R	R	R	R	DW	W/F	DW	DW	
	Cleare (2+6)	R	R	<Y/G	G	R	R	R	R	DW	DW	DW	DW	
(2+6) <b>(Recall)</b>	Dwell	G	G	G	G	R	R	R	R	W/F	W/F	DW	DW	
	Cleare 1 (3+7)	Y	Y	Y	Y	R	R	R	R	DW	DW	DW	DW	
	Cleare 2 (3+8)	Y	Y	Y	Y	R	R	R	R	DW	DW	DW	DW	
	Cleare 3 (4+7)	Y	Y	Y	Y	R	R	R	R	DW	DW	DW	DW	
	Cleare 4 (4+8)	Y	Y	Y	Y	R	R	R	R	DW	DW	DW	DW	
(3+7) <b>(ACTUATED)</b>	Dwell	R	R	R	R	<G/R	R	<G/R	R	DW	DW	DW	DW	
	Cleare 1 (3+8)	R	R	R	R	<G/R	R	<Y/R	R	DW	DW	DW	DW	
	Cleare 2 (4+7)	R	R	R	R	<Y/R	R	<G/R	R	DW	DW	DW	DW	
	Cleare 3 (4+8)	R	R	R	R	<Y/R	R	<Y/R	R	DW	DW	DW	DW	
	Cleare 4 (1+5)	R	R	R	R	<Y/R	R	<Y/R	R	DW	DW	DW	DW	
	Cleare 5 (1+6)	R	R	R	R	<Y/R	R	<Y/R	R	DW	DW	DW	DW	
	Cleare 6 (2+5)	R	R	R	R	<Y/R	R	<Y/R	R	DW	DW	DW	DW	
	Cleare 7 (2+6)	R	R	R	R	<Y/R	R	<Y/R	R	DW	DW	DW	DW	
(3+8) <b>(ACTUATED)</b>	Dwell	R	R	R	R	<G/G	G	R	R	DW	DW	W/F	DW	
	Cleare 1 (4+8)	R	R	R	R	<Y/G	G	R	R	DW	DW	DW	DW	
	Cleare 2 (1+5)	R	R	R	R	<Y/Y	Y	R	R	DW	DW	DW	DW	
	Cleare 3 (1+6)	R	R	R	R	<Y/Y	Y	R	R	DW	DW	DW	DW	
	Cleare 4 (2+5)	R	R	R	R	<Y/Y	Y	R	R	DW	DW	DW	DW	
	Cleare 5 (2+6)	R	R	R	R	<Y/Y	Y	R	R	DW	DW	DW	DW	
(4+7) <b>(ACTUATED)</b>	Dwell	R	R	R	R	R	R	<G/G	G	DW	DW	DW	W/F	
	Cleare 1 (4+8)	R	R	R	R	R	R	<Y/G	G	DW	DW	DW	DW	
	Cleare 2 (1+5)	R	R	R	R	R	R	<Y/Y	Y	DW	DW	DW	DW	
	Cleare 3 (1+6)	R	R	R	R	R	R	<Y/Y	Y	DW	DW	DW	DW	
	Cleare 4 (2+5)	R	R	R	R	R	R	<Y/Y	Y	DW	DW	DW	DW	
	Cleare 5 (2+6)	R	R	R	R	R	R	<Y/Y	Y	DW	DW	DW	DW	
(4+8) <b>(ACTUATED)</b>	Dwell	R	R	R	R	G	G	G	G	DW	DW	W/F	W/F	
	Cleare 1 (1+5)	R	R	R	R	Y	Y	Y	Y	DW	DW	DW	DW	
	Cleare 2 (1+6)	R	R	R	R	Y	Y	Y	Y	DW	DW	DW	DW	
	Cleare 3 (2+5)	R	R	R	R	Y	Y	Y	Y	DW	DW	DW	DW	
	Cleare 4 (2+6)	R	R	R	R	Y	Y	Y	Y	DW	DW	DW	DW	
	Cleare 5 (2+6)	R	R	R	R	Y	Y	Y	Y	DW	DW	DW	DW	

Page 1 of 1

## Miami-Dade County Public Works Department

Drawn <b>H. FRANTILLON</b>	Date <b>11/2/07</b>	<b>BIRD RD &amp; LEJEUNE RD</b>		
Checked <b>H. HERNANDEZ</b>	Date <b>4/16/07</b>	Placed in Service Date <b>5/17/07</b>	By	Phasing No. <b>7</b>
			Asset Number <b>2595</b>	

**SIGNAL HEAD DETAILS**

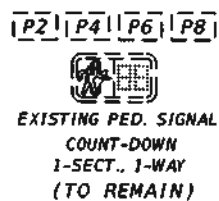
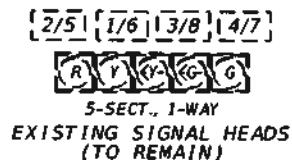

**SIGN DETAILS**

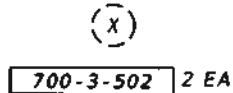

**DETECTORS FOR LOOPS**

LOOP	NO. OF LOOPS	NO. OF NEW DETS.	NO. OF EXIST. DETS.
L-1	1		1
L-3	1		1
L-4	2		1
L-5	1		1
L-7	1		1
L-8	2		1

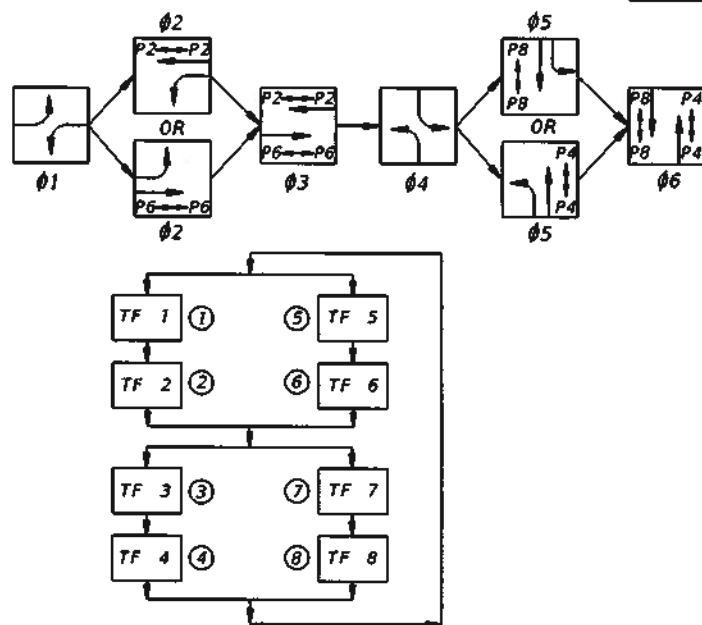

**SIGNAL OPERATION NOTES**

1. MAJOR STREET IS SR 976 BIRD ROAD (SW 40 ST) - TO FLASH YELLOW  
MINOR STREET IS SR 953 LEJEUNE ROAD (SW 42 AVE.) - TO FLASH RED
2. SIGNAL OPERATION PLAN: AS SHOWN.

**NOTES**

1. EXISTING FPL SERVICE POINT AND ATT SERVICE POINT TO REMAIN.
2. FINAL TIMING TO BE PROVIDED BY MIAMI-DADE COUNTY DEPARTMENT OF TRANSPORTATION AND PUBLIC WORKS, TRAFFIC SIGNALS & SIGNS DIVISION.
3. LOOP ASSEMBLIES SHALL BE 6'X30' FOR ALL LANES.
4. AT NW CORNER. INSTALL CONDUIT TO INTERCEPT EXISTING LOOP WINDOW TO ACCESS EXISTING LOOP PULL BOX ON THE SIDEWALK.
5. EXISTING CONDUITS BEFORE BEING UTILIZED SHALL HAVE A BRUSH OR A SWAB PULL THROUGH TO MAKE CERTAIN THAT CONDUITS ARE FREE FROM OBSTRUCTION. COST OF THIS WORK SHALL BE INCLUDED IN THE RELATED PAY ITEM.
6. CONNECT PROPOSED CONDUITS TO EXISTING CONDUITS LOCATED AT EXISTING PULL BOX LOCATIONS.
7. MODIFICATIONS TO THE EXISTING CONTROLLER CABINET INCLUDE ALL WIRING AND CONNECTIONS ACCORDING TO THE SOP SHOWN AND THE TIMING SHEET PROVIDED BY THE COUNTY, FROM THE TERMINAL BOARD TO AND INCLUDING ALL CONTROLLER UNITS, PREEMPTOR, FLASHERS, RELAYS, COORDINATING UNITS, RADIOS, SWITCHES, SERVICE LEAD-INS, INTERCONNECT AND ANY OTHER EQUIPMENT NECESSARY TO PROVIDE SATISFACTORY OPERATIONS TO THE EXISTING CONTROLLER CABINET. PROVIDE NEW CONFLICT MONITOR PROGRAM SHEET AND NEW HOOP-UP CHART, BASED ON THE SOP SHOWN AND TIMING PROVIDED BY THE COUNTY.

**EXISTING CONTROLLER**

670-5-400 1 AS  
632-7-2 320 LF

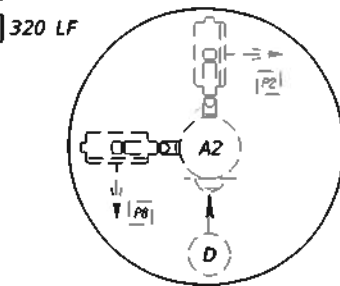

EXIST. SIGNAL MAST ARM  
INSTALL BACKPLATES ON  
EXISTING SIGNAL HEADS  
650-2-102 3 EA

630-2-12 45 LF  
635-2-11 2 EA  
660-2-101 1 AS

EXIST. FPL & ATT SERVICE POINT  
EXIST. CONTROLLER BOX

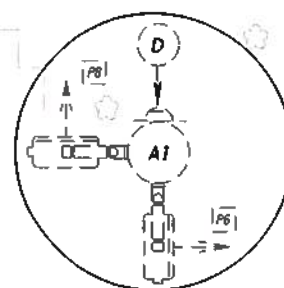

NOTE:  
\* RELOCATE EXISTING STREET NAME SIGN. CENTROID OF RELOCATED SIGN TO BE 6' FROM MAST ARM POLE.

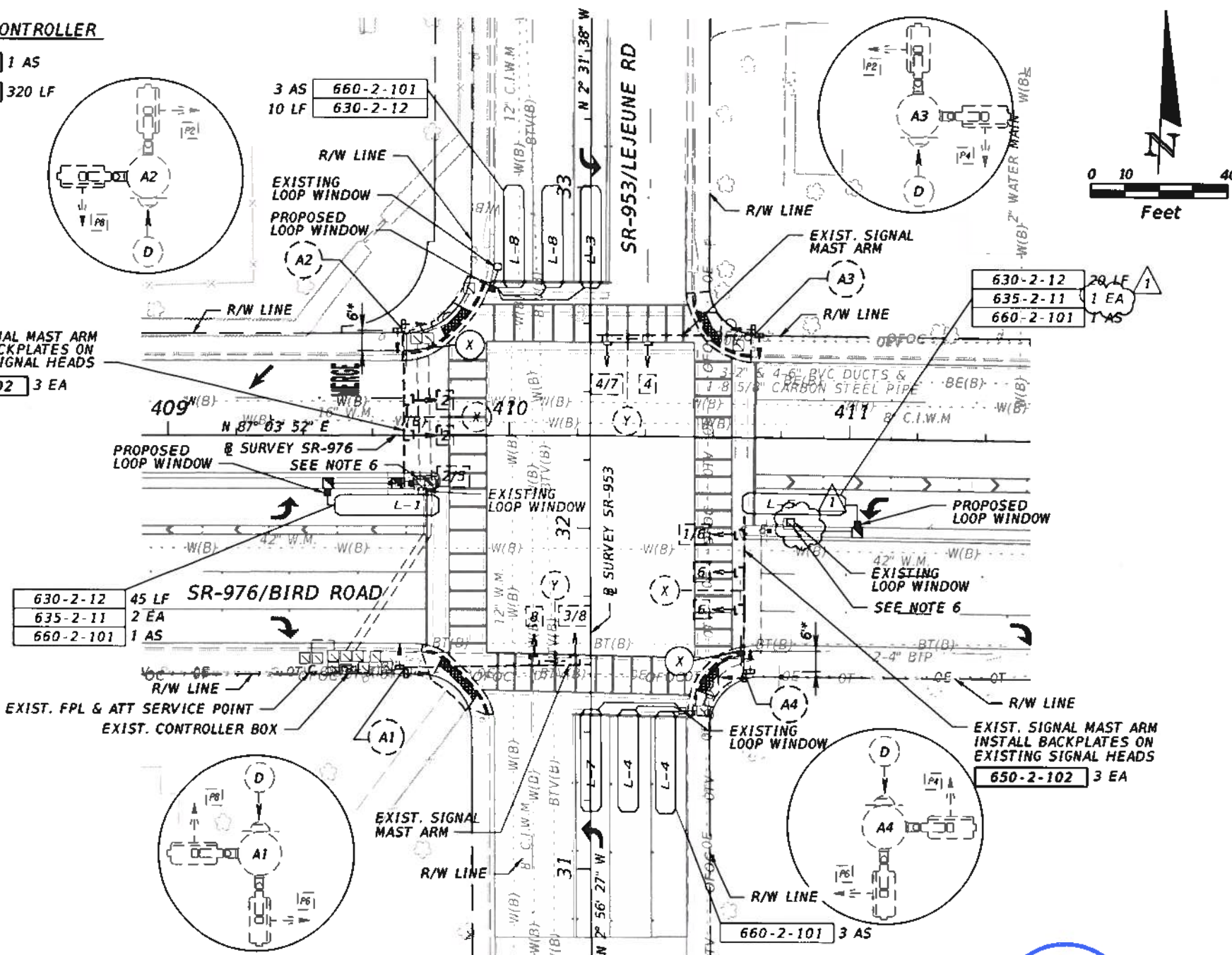

7900 NW 60 Street  
Doral, FL 33186

*[Signature]*  
4/11/18

SR 953/SW 42nd AVENUE/LEJEUNE ROAD  
AND SR 976/SW 40th STREET/BIRD ROAD  
INTERSECTION I.D.# 2595

**REVISIONS**

DATE	DESCRIPTION	DATE	DESCRIPTION
04/10/18	1 REMOVED PULL BOXES		

JORGE A. LOPEZ, P.E.  
P.E. LICENSE NUMBER 73797  
H. W. LOCHNER, INC.  
CONSULTING ENGINEERS AND PLANNERS  
8750 NW 36th STREET - SUITE 360  
MIAMI, FLORIDA - 33178  
CERTIFICATE OF AUTHORIZATION 00000894

**STATE OF FLORIDA  
DEPARTMENT OF TRANSPORTATION**

ROAD NO.	COUNTY	FINANCIAL PROJECT ID
SR 976	MIAMI-DADE	434766-1-52-01

**SIGNALIZATION PLAN**

SHEET NO.  
T-4

THE OFFICIAL RECORD OF THIS SHEET IS THE ELECTRONIC FILE DIGITALLY SIGNED AND SEALED UNDER RULE 61G15-23.004, F.A.C.

LIMITS OF SIGNING AND PAVEMENT MARKINGS  
MATCH EXISTING PAVEMENT MARKINGS\*  
STA. 33+44.00

BEGIN SIGNING AND PAVEMENT MARKINGS  
MATCH EXISTING PAVEMENT MARKINGS\*  
STA. 407+20.00

LIMITS OF SIGNING AND PAVEMENT MARKINGS  
MATCH EXISTING PAVEMENT MARKINGS\*  
STA. 30+80.00

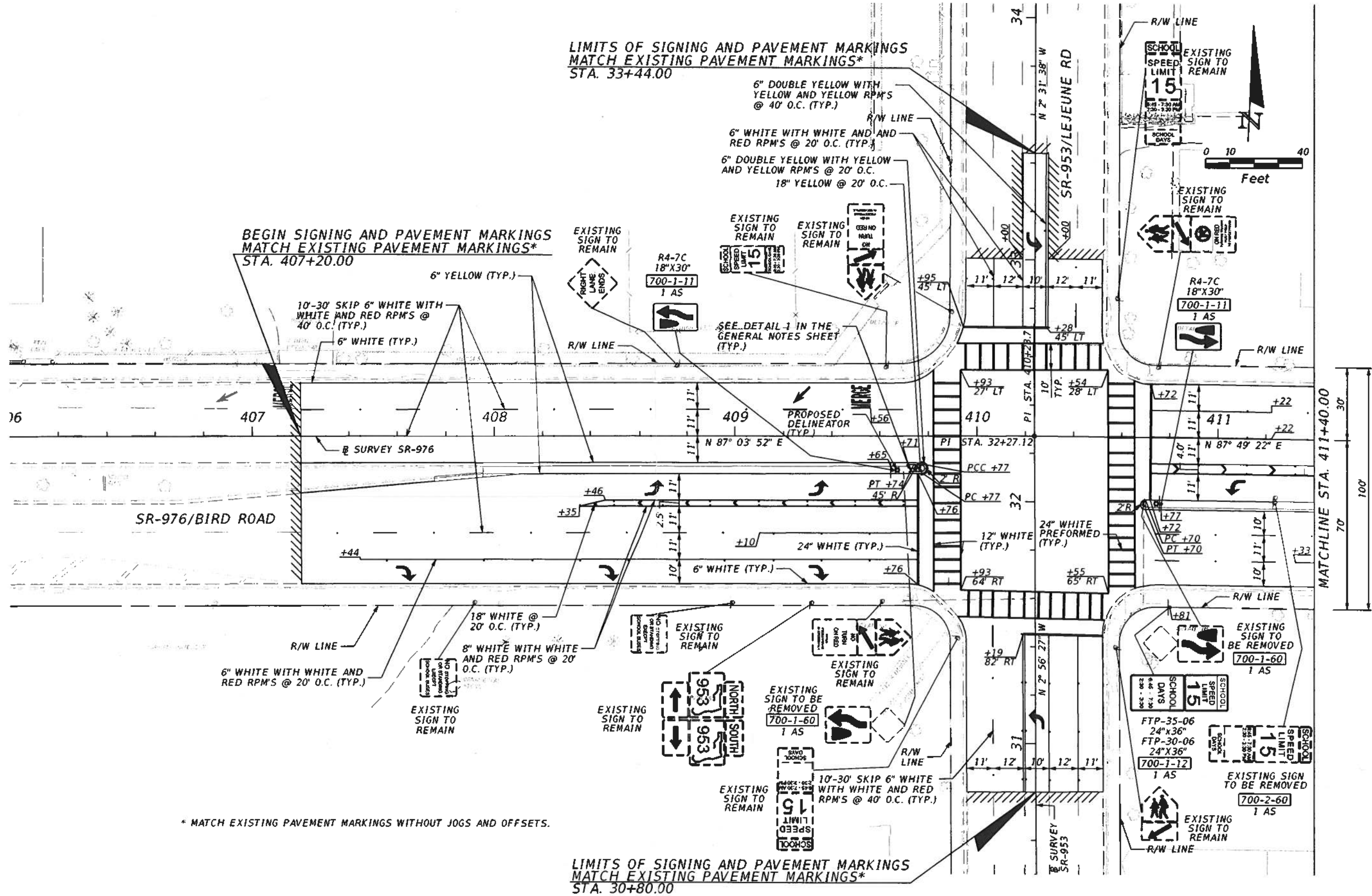

\* MATCH EXISTING PAVEMENT MARKINGS WITHOUT JOGS AND OFFSETS.



REVISIONS		REVISIONS	
DATE	DESCRIPTION	DATE	DESCRIPTION

TRACE CONSULTANTS, INC.  
12485 SW 137 AVENUE, SUITE 207  
MIAMI, FLORIDA 33186  
TEL. (305) 281-1195  
C.A. NO. 29942  
ENGINEER OF RECORD: FAVIO LAVERDE, P.E. NO. 63546

STATE OF FLORIDA DEPARTMENT OF TRANSPORTATION		
ROAD NO.	COUNTY	FINANCIAL PROJECT ID
SR 976	MIAMI-DADE	434766-1-52-01

**SIGNING AND PAVEMENT  
MARKING PLAN**

SHEET NO.  
S-4

THE OFFICIAL RECORD OF THIS SHEET IS THE ELECTRONIC FILE DIGITALLY SIGNED AND SEALED UNDER RULE 61G15-23.004, F.A.C.









**TOD Schedule Report**  
for 2595: Bird Rd&LeJeune Rd

Print Date:  
2/24/2020

Print Time:  
12:07 PM

<u>Asset</u>	<u>Intersection</u>	<u>TOD Schedule</u>	<u>Op Mode</u>	<u>Plan #</u>	<u>Cycle</u>	<u>Offset</u>	<u>TOD Setting</u>	<u>Active PhaseBank</u>	<u>Active Maximum</u>
2595	Bird Rd&LeJeune Rd	DOW-2	TOD	[06] MID-MORNING	150	16	N/A	1	Max 2

**Splits**

<u>PH 1</u>	<u>PH 2</u>	<u>PH 3</u>	<u>PH 4</u>	<u>PH 5</u>	<u>PH 6</u>	<u>PH 7</u>	<u>PH 8</u>
EBL	WBT	SBL	NBT	WBL	EBT	NBL	SBT
5	72	9	38	5	72	9	38
							

Active Phase Bank: Phase Bank 1

<u>Phase</u>	<u>Walk</u>			<u>Don't Walk</u>			<u>Min Initial</u>			<u>Veh Ext</u>			<u>Max Limit</u>			<u>Max 2</u>			<u>Yellow</u>	<u>Red</u>
	1	2	3	1	2	3	1	2	3	1	2	3	1	2	3	1	2	3		
1 EBL	0	0	0	0	0	0	5	5	5	3.5	2	2	7	7	7	21	10	10	4	2
2 WBT	7	7	7	14	14	14	7	7	7	1	1	1	28	28	28	0	67	67	4	2
3 SBL	0	0	0	0	0	0	5	5	5	2	2	2	7	7	7	20	10	10	4.4	2.5
4 NBT	7	7	7	24	24	24	7	7	7	2.7	2.7	2.7	26	26	26	63	34	34	4.4	2.5
5 WBL	0	0	0	0	0	0	5	5	5	2.5	2	2	7	7	7	13	10	10	4	2
6 EBT	7	7	7	14	14	14	7	7	7	1	1	1	28	28	28	0	67	67	4	2
7 NBL	0	0	0	0	0	0	5	5	5	2	2	2	7	7	7	20	10	10	4.4	2.5
8 SBT	7	7	7	24	24	24	7	7	7	2.7	2.7	2.7	26	26	26	63	34	34	4.4	2.5

Last In Service Date: 12/22/2010 14:33

**Permitted Phases**

	<b>12345678</b>
Default	12345678
External Permit 0	-2-4-6-8
External Permit 1	-2-4-6-8
External Permit 2	-2-4-6-8

**TOD Schedule Report**  
for 2595: Bird Rd&LeJeune Rd

Print Date:  
2/24/2020

Print Time:  
12:07 PM

Current TOD Schedule	Plan	Cycle	Green Time								Ring Offset	Offset
			1 EBL	2 WBT	3 SBL	4 NBT	5 WBL	6 EBT	7 NBL	8 SBT		
	Free											
0130	Free											
0500	Free											
0530	5	140	5	63	6	40	5	63	6	40	0	66
0600	11	180	20	74	11	49	7	87	11	49	0	132
1030	6	150	5	72	9	38	5	72	9	38	0	16
1500	13	180	5	84	6	59	12	77	6	59	0	23
2000	6	150	5	72	9	38	5	72	9	38	0	16
2100	9	100	6	37	5	26	6	37	5	26	0	80
	1	140	8	61	18	27	8	61	18	27	0	34
	2	100	7	29	19	19	7	29	19	19	0	74
	3	120	8	42	19	25	8	42	19	25	0	34
	4	130	8	51	19	26	8	51	19	26	0	42
	7	140	5	67	10	32	5	67	10	32	0	76
	8	120	8	55	9	22	8	55	9	22	0	26
	10	110	6	47	9	22	6	47	9	22	0	6
	12	130	6	55	9	34	6	55	9	34	0	74
	15	140	5	69	10	30	5	69	10	30	0	128
	16	120	5	58	9	22	5	58	9	22	0	14
	17	120	6	59	7	22	6	59	7	22	0	76
	18	110	6	50	6	22	6	50	6	22	0	48
	20	80	6	22	4	22	6	22	4	22	0	52
	21	80	6	22	4	22	6	22	4	22	0	52
	22	80	6	22	4	22	6	22	4	22	0	52
	23	80	6	22	4	22	6	22	4	22	0	52

Local TOD Schedule			
Time	Plan	DOW	
0000	21	Su	S
0000	Free	M T W Th F	
0115	Free	Su	S
0130	Free	M T W Th F	
0230	Free	Su	S
0500	Free	M T W Th F	
0530	5	M T W Th F	
0600	11	M T W Th F	
0600	6	Su	S
1030	6	M T W Th F	
1500	13	M T W Th F	
2000	6	M T W Th F	
2100	9	M T W Th F	
2300	21	Su	S

**Current Time of Day Function**

Time	Function	Settings *	Day of Week
0000	TOD OUTPUTS	-----	SuM T W ThF S

**Local Time of Day Function**

Time	Function	Settings *	Day of Week
0000	TOD OUTPUTS	-----	SuM T W ThF S

**\* Settings**

- Blank - FREE - Phase Bank 1, Max 1
- Blank - Plan - Phase Bank 1, Max 2
- 1 - Phase Bank 2, Max 1
- 2 - Phase Bank 2, Max 2
- 3 - Phase Bank 3, Max 1
- 4 - Phase Bank 3, Max 2
- 5 - EXTERNAL PERMIT 1
- 6 - EXTERNAL PERMIT 2
- 7 - X-PED OMIT
- 8 - TBA

**TOD Schedule Report**  
**for 2595: Bird Rd&LeJeune Rd**

Print Date:  
2/24/2020

Print Time:  
**12:07 PM**

*No Calendar Defined/Enabled*

# SIGNAL OPERATING PLAN



Timing Phases	Direction	SB	NR	WB	EB	Ped Heads		Movements/Display/Actuation
	Head No.	Z	G	4	8		R2	
2+6 N/S LEJEUNE Rd  RECALL	Dwell	G	G	R	R		DW	
	C	Y	Y	R	R		DW	
	i							
	e							
	r							
4+8 E/W ALTARA AV  ACTUATED	Dwell	R	R	G	G		W/F	
	C	R	R	Y	Y		DW	
	i							
	e							
	r							
	Dwell							
	C							
	i							
	e							
	r							
	Dwell							
	C							
	i							
	e							
	r							
	Dwell							
	C							
	i							
	e							
	r							

Flashing Operation    **FY** **FY** **FR** **FR**    Page 1 of 1

## Miami-Dade County Public Works Department

Drawn <b>H. FRANKILLON</b>	Date <b>5/14/07</b>	<b>LEJEUNE Rd &amp; ALTARA AV</b>		
Checked <b>H. HEMMONDS</b>	Date <b>5/14/07</b>	Placed in Service Date	By <b>SSI</b>	Phasing No. <b>3</b>
			Asset Number <b>3272</b>	



**SIGNAL HEAD & SIGN DETAIL**

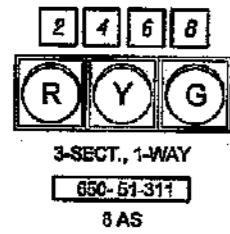

COST OF SPECIAL SIGN TO BE INCLUDED IN PAY ITEM 655-11

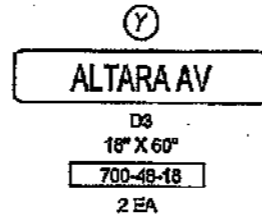
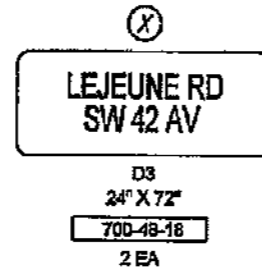

**NOTES**

- SIGNAL TIMING TO BE PROVIDED BY MIAMI-DADE COUNTY SIGNAL DIVISION.
- LOOP ASSEMBLY 680-2-101 DEVIATES FROM F.D.O.T. STANDARDS AND SHALL BE 5' X 30' FOR THRU LANES, 5' X 30' FOR LEFT OR RIGHT TURNING LANES.
- OVERHEAD STREET SIGNS (X) AND (Y) SHALL USE "C" SERIES NUMBERS (10" IN HEIGHT) AND LETTERS (6" IN HEIGHT). THE SPACE BETWEEN LETTERS COULD BE REDUCED IN ORDER TO COMPLY WITH LETTER SIZE AND OVERALL DIMENSION IN THE OVERHEAD STREET NAME SIGNS.
- CONTRACTOR TO MAINTAIN INTERCONNECTED OPERATION WITH EXISTING CABLE UNTIL INTERSECTION IS CONNECTED TO COMPUTER SYSTEM.
- PAY ITEM 680-100 INCLUDES THE REMOVAL OF EXISTING PULL BOXES IN THE INTERSECTION.

**CONTROLLER OPERATION**

- MAJOR STREET: SW 42 AV / LEJEUNE RD.  
MINOR STREETS: ALTARA AV.
- SOP No. 1
- PHASE 2 ACTUATED, PHASE 1 RECALL
- FLASHING OPERATION: 2, 6 - YELLOW  
4, 8 - RED

DETECTORS FOR LOOPS		
LOOP	NO. OF LOOPS	NO. OF DETS.
L-4	1	1
L-8	1	1

**CONTROLLER ITEMS**

- 682-7-1 1 PI
- 685-1-11 5 EA
- 680-1-108 2 EA
- 670-S-120 1 AS
- 685-120 1 EA
- 685-124 1 EA

**REMOVAL ITEMS**

- 680-10 8 EA
- 680-20 2 EA
- 680-38-1 60 LF
- 680-50-2 1 EA
- 680-80 1 EA
- 680-90 1 PI
- 680-100 1 PI

**SERVICE POINT ITEMS**

- 685-1-11 3 EA
- 689-1-11 1 AS
- 688-2-1 380 LF

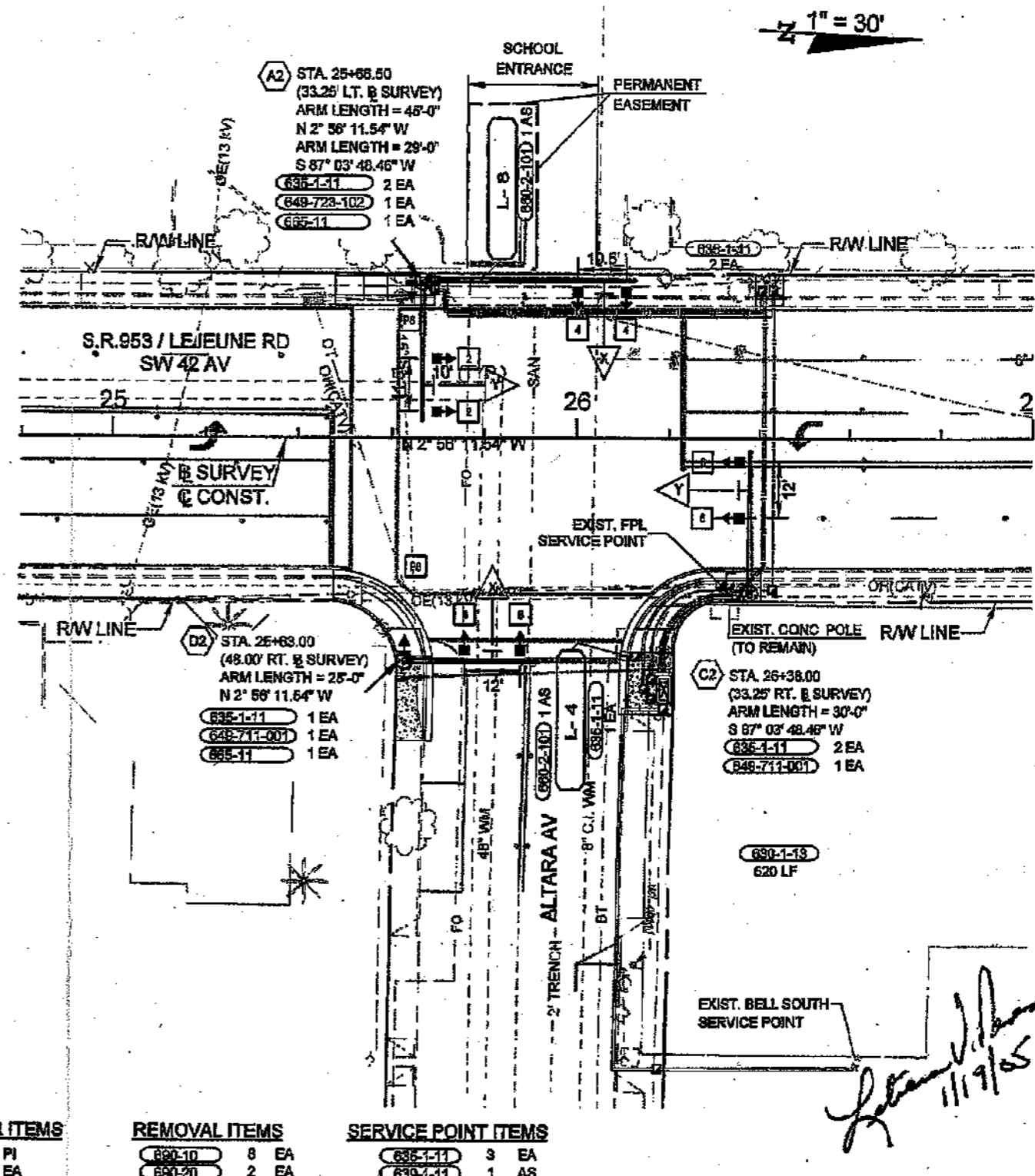

S.R.953 / SW 42 AV. / LEJEUNE RD.  
AND ALTARA AV.  
I.D. 3272 Sect 49

*Handwritten signature and date: 11/19/05*

REVISIONS					
DATE	BY	DESCRIPTION	DATE	BY	DESCRIPTION

ENGINEER OF RECORD:  
  
 A&P Consulting Transportation Engineers Corporation  
 4525 NW 41 Street, Suite 116  
 Miami, FL 33178  
 (305) 482-7285 Fax: (305) 563-1884  
 E-MAIL: E-0067767  
 Letitia V. Peters, P.E. No. 47080

STATE OF FLORIDA DEPARTMENT OF TRANSPORTATION		
ROAD NO.	COUNTY	FINANCIAL PROJECT ID
S.R.953	MIAMI-DADE	407633-1-52-01

**SIGNALIZATION PLAN**

SHEET NO.	T-5
-----------	-----

**LOOP**

CORAL GABLES SENIOR HIGH SCHOOL

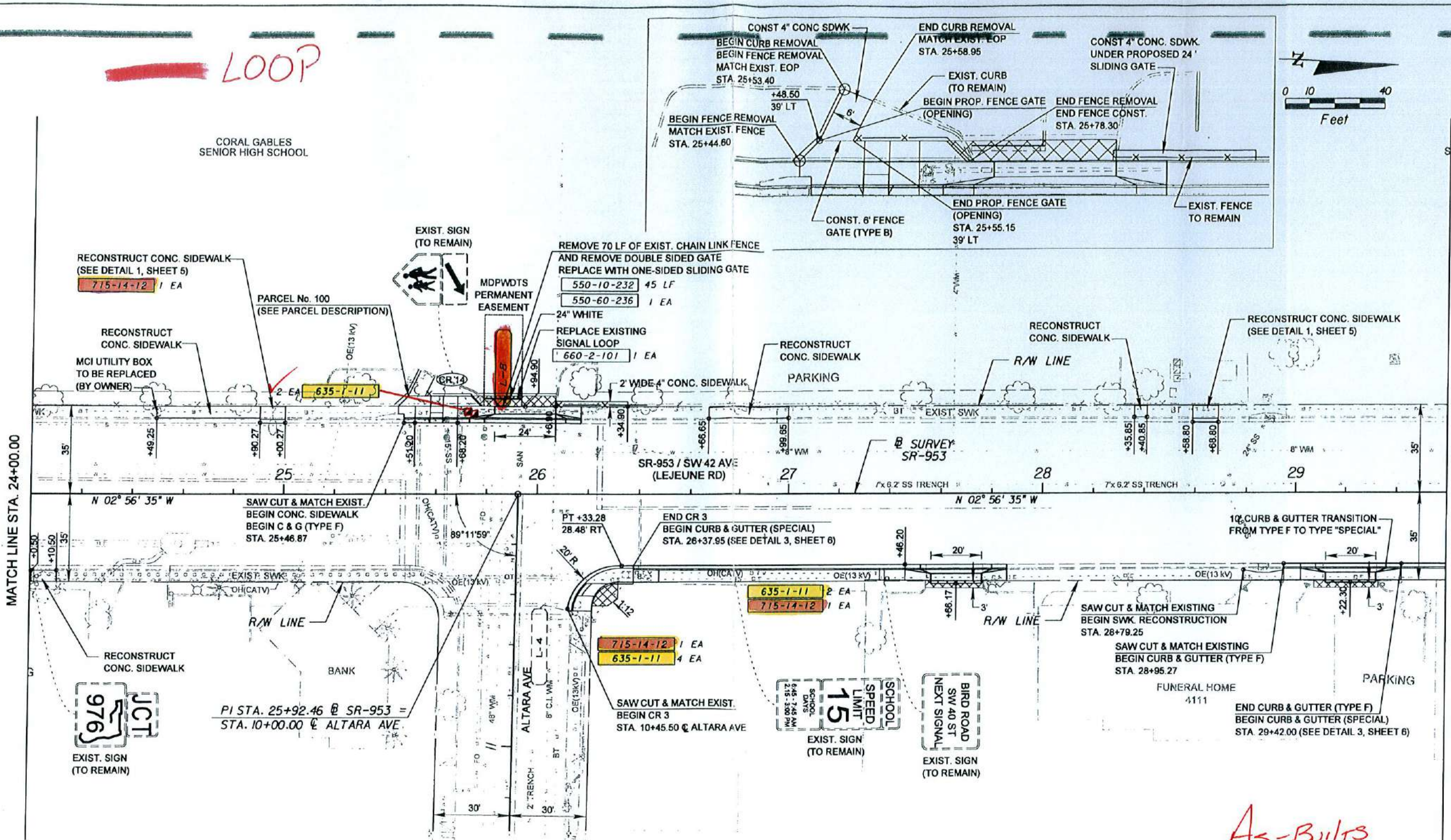
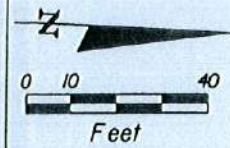

⊞ DENOTES HARMONIZATION

**NOTE:**  
 DEPICTED SURVEY IN VICINITY OF PROPOSED IMPROVEMENTS WAS GATHERED FOR THIS PROJECT. REMAINING TOPOGRAPHIC INFORMATION IS BASED ON AN EXISTING FLOWN SURVEY AND IS FOR INFORMATIONAL PURPOSES ONLY.

*As-Built*  
*[Signature]*  
 11-4-2011  
 FLORIDA SOL SYSTEMS

NOTICE: THE OFFICIAL RECORD OF THIS SHEET IS THE ELECTRONIC FILE SIGNED AND SEALED UNDER RULE 6G05-23.003, F.A.C.

REVISIONS				CH PEREZ & ASSOCIATES CONSULTING ENGINEERS, INC CERTIFICATE OF AUTHORIZATION NO. EB-25976 9594 NW 41 STREET, SUITE 201 MIAMI, FLORIDA 33178 (305)592-1070 / FAX: (305)592-1078	STATE OF FLORIDA DEPARTMENT OF TRANSPORTATION			SHEET NO. 19
DATE	DESCRIPTION	DATE	DESCRIPTION		ROAD NO.	COUNTY	FINANCIAL PROJECT ID	
				CARLOS H. PEREZ, P.E. P.E. LICENSE NO. 52060	953	MIAMI-DADE	407633-3-52-01	

**ROADWAY PLANS**

**TOD Schedule Report**  
for 3272: Altara Av&LeJeune Rd

Print Date:  
2/24/2020

Print Time:  
12:07 PM

<u>Asset</u>	<u>Intersection</u>	<u>TOD Schedule</u>	<u>Op Mode</u>	<u>Plan #</u>	<u>Cycle</u>	<u>Offset</u>	<u>TOD Setting</u>	<u>Active PhaseBank</u>	<u>Active Maximum</u>
3272	Altara Av&LeJeune Rd	DOW-2	TOD	[06] MID-MORNING	150	73	N/A	1	Max 2

**Splits**

<u>PH 1</u>	<u>PH 2</u>	<u>PH 3</u>	<u>PH 4</u>	<u>PH 5</u>	<u>PH 6</u>	<u>PH 7</u>	<u>PH 8</u>
-	SBT	-	WBT	-	NBT	-	EBT
0	107	0	31	0	107	0	31



Active Phase Bank: Phase Bank 1

<u>Phase</u>	<u>Walk</u>			<u>Don't Walk</u>			<u>Min Initial</u>			<u>Veh Ext</u>			<u>Max Limit</u>			<u>Max 2</u>			<u>Yellow</u>	<u>Red</u>
	1	2	3	1	2	3	1	2	3	1	2	3	1	2	3	1	2	3		
1 -	0	0	0	0	0	0	0	0	0	0	0	0	0	0	0	0	0	0	0	0
2 SBT	0	0	0	0	0	0	16	16	16	1	1	1	40	40	40	0	40	40	4	2
3 -	0	0	0	0	0	0	0	0	0	0	0	0	0	0	0	0	0	0	0	0
4 WBT	0	0	0	0	0	0	7	7	7	3	-2.5	-2.5	15	15	15	20	47	31	4	2.3
5 -	0	0	0	0	0	0	0	0	0	0	0	0	0	0	0	0	0	0	0	0
6 NBT	0	0	0	0	0	0	16	16	16	1	1	1	40	40	40	0	40	40	4	2
7 -	0	0	0	0	0	0	0	0	0	0	0	0	0	0	0	0	0	0	0	0
8 EBT	7	11	7	13	13	13	7	7	7	2.5	-2.5	-2.5	15	15	15	20	47	31	4	2.3

Last In Service Date: unknown

<b>Permitted Phases</b>	
	<b>12345678</b>
Default	-2-4-6-8
External Permit 0	-----
External Permit 1	-----
External Permit 2	-----

**TOD Schedule Report**  
for 3272: Altara Av&LeJeune Rd

Print Date:  
2/24/2020

Print Time:  
12:07 PM

Current TOD Schedule	Plan	Cycle	Green Time								Ring Offset	Offset
			1	2	3	4	5	6	7	8		
			-	SBT	-	WBT	-	NBT	-	EBT		
	Free											
0200	Flash											
0500	Free											
0530	5	140	0	99	0	29	0	99	0	29	0	5
0600	11	180	0	123	0	45	0	123	0	45	0	82
1030	6	150	0	107	0	31	0	107	0	31	0	73
1500	13	180	0	123	0	45	0	123	0	45	0	134
2000	6	150	0	107	0	31	0	107	0	31	0	73
2100	9	100	0	68	0	20	0	68	0	20	0	28
	1	140	0	108	0	20	0	108	0	20	0	131
	2	100	0	58	0	30	0	58	0	30	0	31
	3	120	0	88	0	20	0	88	0	20	0	11
	4	130	0	99	0	19	0	99	0	19	0	103
	7	140	0	102	0	26	0	102	0	26	0	111
	8	120	0	88	0	20	0	88	0	20	0	103
	10	110	0	78	0	20	0	78	0	20	0	6
	12	130	0	98	0	20	0	98	0	20	0	63
	15	140	0	102	0	26	0	102	0	26	0	130
	16	120	0	84	0	24	0	84	0	24	0	72
	17	120	0	84	0	24	0	84	0	24	0	22
	18	110	0	75	0	23	0	75	0	23	0	109

Local TOD Schedule			
Time	Plan	DOW	
0000	Free	Su	S
0000	Free	Su M T W Th F	S
0200	Flash	M T W Th F	
0230	Free	Su	S
0500	Free	M T W Th F	
0530	5	M T W Th F	
0600	11	M T W Th F	
0600	Free	Su	S
1030	6	M T W Th F	
1500	13	M T W Th F	
2000	6	M T W Th F	
2100	9	M T W Th F	

Current Time of Day Function			
Time	Function	Settings *	Day of Week
0000	TOD OUTPUTS	-----	SuM T W ThF S
0220	TOD OUTPUTS	-----2-	M T W ThF
0245	TOD OUTPUTS	-----	M T W ThF
0650	TOD OUTPUTS	-----2-	M T W ThF
0720	TOD OUTPUTS	-----	M T W ThF

Local Time of Day Function			
Time	Function	Settings *	Day of Week
0000	TOD OUTPUTS	-----	SuM T W ThF S
0220	TOD OUTPUTS	-----2-	M T W ThF
0245	TOD OUTPUTS	-----	M T W ThF
0650	TOD OUTPUTS	-----2-	M T W ThF
0720	TOD OUTPUTS	-----	M T W ThF

* Settings
Blank - FREE - Phase Bank 1, Max 1
Blank - Plan - Phase Bank 1, Max 2
1 - Phase Bank 2, Max 1
2 - Phase Bank 2, Max 2
3 - Phase Bank 3, Max 1
4 - Phase Bank 3, Max 2
5 - EXTERNAL PERMIT 1
6 - EXTERNAL PERMIT 2
7 - X-PED OMIT
8 - TBA

**TOD Schedule Report**  
**for 3272: Altara Av&LeJeune Rd**

Print Date:  
2/24/2020

Print Time:  
**12:07 PM**

*No Calendar Defined/Enabled*

# SIGNAL OPERATING PLAN



Timing Phases	Direction	NB		SB	EB	Ped Heads				Movements/Display/Actuation
	Head No.	1/6	6	2	8	P6	P2	P8	P4	
(1+6) Ponce NL  (Actuated)	Dwell	G/<G	G	R	R			DW		
	C	(2+6)	G/<Y	G	R	R		DW		
	l									
	e									
	a									
(2+6) Ponce NS  (Recall)	Dwell	G	G	G	R			DW		
	C	(4+8)	Y	Y	Y	R		DW		
	l									
	e									
	a									
(8) Av. Sn. Lorenzo EB  (Actuated)	Dwell	R	R	R	G			W/F		
	C	(2+6)	R	R	R	Y		DW		
	l									
	e									
	a									
Flashing Operation		FY	FY	FY	FR					Page 1 of 1

## Miami-Dade County Public Works Department

Drawn H. Hernandez	Date 8/26/2002	Ponce de Leon Blvd & Avenue San Lorenzo			
Checked 	Date 8/26/02	Placed in Service	Phasing No.	Asset Number	
		Date 8/27/02 By	1	6165	

## TOD Schedule Report

for 6165: Ponce De Leon Blvd&San Lorenzo Av

Print Date:  
2/24/2020

Print Time:  
12:08 PM

<u>Asset</u>	<u>Intersection</u>	<u>TOD Schedule</u>	<u>Op Mode</u>	<u>Plan #</u>	<u>Cycle</u>	<u>Offset</u>	<u>TOD Setting</u>	<u>Active PhaseBank</u>	<u>Active Maximum</u>
6165	Ponce De Leon Blvd&San Lorenzo Av	DOW-2	TOD	[06] MID-MORNING	75	27	N/A	1	Max 2

### Splits

<u>PH 1</u>	<u>PH 2</u>	<u>PH 3</u>	<u>PH 4</u>	<u>PH 5</u>	<u>PH 6</u>	<u>PH 7</u>	<u>PH 8</u>
NBL	SBT	-	-	-	NBT	-	EBT
6	33	0	0	0	45	0	17



Active Phase Bank: Phase Bank 1

Phase	<u>Walk</u>			<u>Don't Walk</u>			<u>Min Initial</u>			<u>Veh Ext</u>			<u>Max Limit</u>			<u>Max 2</u>			<u>Yellow</u>	<u>Red</u>
	1	2	3	1	2	3	1	2	3	1	2	3	1	2	3	1	2	3		
1 NBL	0	0	0	0	0	0	5	5	5	2	2	2	7	7	7	15	7	7	3.7	2.6
2 SBT	0	0	0	0	0	0	15	15	15	2.5	2.5	2.5	40	40	40	0	0	0	4	2.6
3 -	0	0	0	0	0	0	0	0	0	0	0	0	0	0	0	0	0	0	0	0
4 -	0	0	0	0	0	0	0	0	0	0	0	0	0	0	0	0	0	0	0	0
5 -	0	0	0	0	0	0	0	0	0	0	0	0	0	0	0	0	0	0	0	0
6 NBT	0	0	0	0	0	0	15	15	15	2.5	2.5	2.5	40	40	40	0	0	0	4	2.6
7 -	0	0	0	0	0	0	0	0	0	0	0	0	0	0	0	0	0	0	0	0
8 EBT	7	7	7	10	10	10	7	7	7	2.5	2.5	2.5	12	12	12	32	32	32	4	2.3

Last In Service Date: unknown

<b>Permitted Phases</b>	
	<b>12345678</b>
Default	12---6-8
External Permit 0	-----
External Permit 1	-2---6-8
External Permit 2	-2---6-8

## TOD Schedule Report

for 6165: Ponce De Leon Blvd&San Lorenzo Av

Print Date:  
2/24/2020

Print Time:  
12:08 PM

Current TOD Schedule	Plan	Cycle	Green Time								Ring Offset	Offset
			1 NBL	2 SBT	3 -	4 -	5 -	6 NBT	7 -	8 EBT		
	Free											
0130	Free											
0500	Free											
0530	5	70	6	29	0	0	0	41	0	16	0	11
0600	11	80	7	31	0	0	0	44	0	23	0	40
1030	6	75	6	33	0	0	0	45	0	17	0	27
1500	13	80	6	40	0	0	0	52	0	15	0	5
2000	6	75	6	33	0	0	0	45	0	17	0	27
2100	9	100	11	54	0	0	0	71	0	16	0	5
	1	70	9	27	0	0	0	42	0	15	0	22
	2	100	6	57	0	0	0	69	0	18	0	16
	3	60	6	20	0	0	0	32	0	15	0	8
	4	65	6	27	0	0	0	39	0	13	0	19
	7	70	10	26	0	0	0	42	0	15	0	3
	8	60	6	20	0	0	0	32	0	15	0	6
	10	110	14	59	0	0	0	79	0	18	0	21
	12	65	6	25	0	0	0	37	0	15	0	3
	15	70	8	25	0	0	0	39	0	18	0	7
	16	60	6	20	0	0	0	32	0	15	0	8
	17	60	6	20	0	0	0	32	0	15	0	5
	18	110	10	57	0	0	0	73	0	24	0	6
	21	80	11	35	0	0	0	52	0	15	0	12

Local TOD Schedule			
Time	Plan	DOW	
0000	21	Su	S
0000	Free	M T W Th F	
0115	Free	Su	S
0130	Free	M T W Th F	
0230	Free	Su	S
0500	Free	M T W Th F	
0530	5	M T W Th F	
0600	11	M T W Th F	
0600	6	Su	S
1030	6	M T W Th F	
1500	13	M T W Th F	
2000	6	M T W Th F	
2100	9	M T W Th F	
2300	21	Su	S

Current Time of Day Function			
Time	Function	Settings *	Day of Week
0000	TOD OUTPUTS	-----	SuM T W ThF S

Local Time of Day Function			
Time	Function	Settings *	Day of Week
0000	TOD OUTPUTS	-----	SuM T W ThF S

- \* Settings**
- Blank - FREE - Phase Bank 1, Max 1
  - Blank - Plan - Phase Bank 1, Max 2
  - 1 - Phase Bank 2, Max 1
  - 2 - Phase Bank 2, Max 2
  - 3 - Phase Bank 3, Max 1
  - 4 - Phase Bank 3, Max 2
  - 5 - EXTERNAL PERMIT 1
  - 6 - EXTERNAL PERMIT 2
  - 7 - X-PED OMIT
  - 8 - TBA



**TOD Schedule Report**

**for 6165: Ponce De Leon Blvd&San Lorenzo Av**

Print Date:

**2/24/2020**

Print Time:

**12:08 PM**

***No Calendar Defined/Enabled***

# APPENDIX E

---

## County and City Transit Maps

# Coral Gables

## TROLLEY ROUTE & POINTS OF INTEREST

### Trolley Stops & Route



### Municipal Parking Garage



### Miami-Dade Transit Metrobus Routes



Visit [www.miamidade.gov/transit](http://www.miamidade.gov/transit) for detailed Metrobus routes and stops

### Miami-Dade Metrorail Station



Transfer from the Trolley to the Metrorail to travel to the Miami International Airport, Downtown Miami, University of Miami, Coconut Grove, South Miami or Kendall/Dadeland.

Rotary Centennial Park 1

Freedom Plaza 2

Coral Gables Woman's Club 3

Ponce De Leon Park 4

Phillips Park 5

Hotel Place St. Michel 6

Alhambra Plaza 7

Hyatt Regency Hotel 8

Coral Gables Museum 9

Books & Books 10

Coral Gables Art Cinema 11

Westin Colonnade Hotel 12

Coral Gables City Hall 13

Miracle Mile Shops 14

Merrick Park 15

Miracle Theater 16

Coral Gables Police Department 17

Fred B. Hartnett / Ponce Circle Park 18

Coral Gables War Memorial Youth Center 19

French Normandy Village 20

Coral Gables Senior High School 21

Village of Merrick Park Shopping 22

Coral Gables Hospital 23

Douglas Park (Miami-Dade Park) 24

Coral Gables Elementary School 25

**Monday - Friday, 6:30 a.m. - 8 p.m.**  
**First Friday of the Month**  
**is Gallery Night. Ride until 10 p.m.**

For more information on the Coral Gables Trolley visit [www.coralgables.com](http://www.coralgables.com)

or contact us via phone at 305-460-5070 or E-mail at [trolley@coralgables.com](mailto:trolley@coralgables.com)

City Hall General Inquiries: 305-446-6800

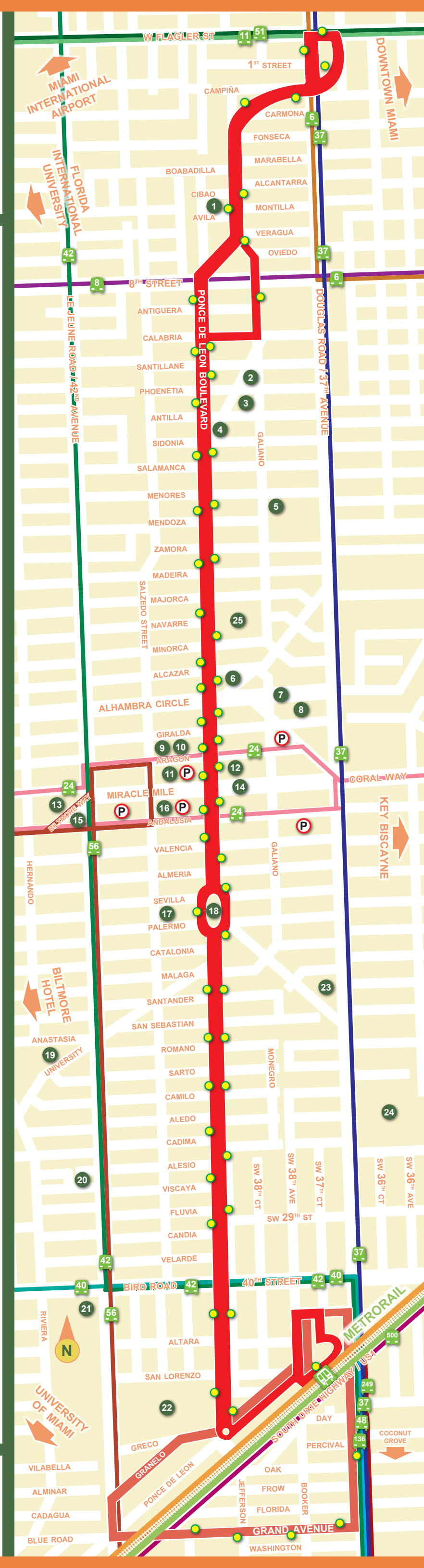

Funding for this program is possible thanks to the Miami-Dade County Half Penny Transportation Surtax, the Florida Department of Transportation and the Metropolitan Planning Organization.



# METROBUS SYSTEM

## MAY 2019

- METROBUS ROUTES**
- Limited-Stop Service
  - Express Service
  - Non-stop Service
  - East-West Local-Stop Service
  - North-South Local-Stop Service
  - Local Shuttle or Circulator Service
- METROBUS DESTINATIONS**
- Service Endpoint - Single Route Type
  - Service Endpoints - Multiple Route Types
  - Terminal
  - Park and Ride Lot
  - South Dade Transit-Way Station
  - MetroRail & Station - Routes Serving Station
  - Tri-Rail
  - Brightline

THIS IS A GENERAL REFERENCE MAP. CONSULT INDIVIDUAL ROUTE MAPS FOR DETAILS.

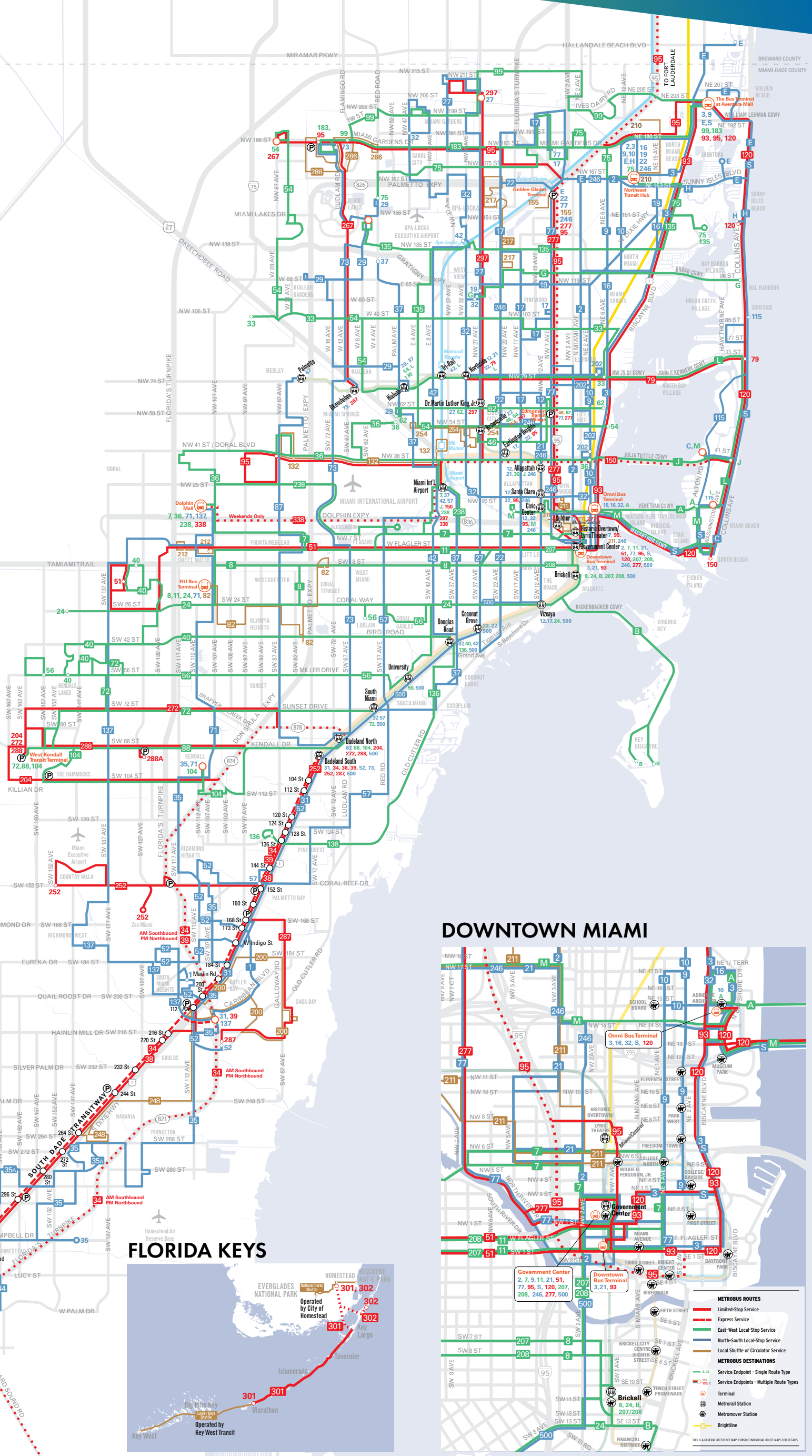

### BROWARD COUNTY



### FLORIDA KEYS



### DOWNTOWN MIAMI

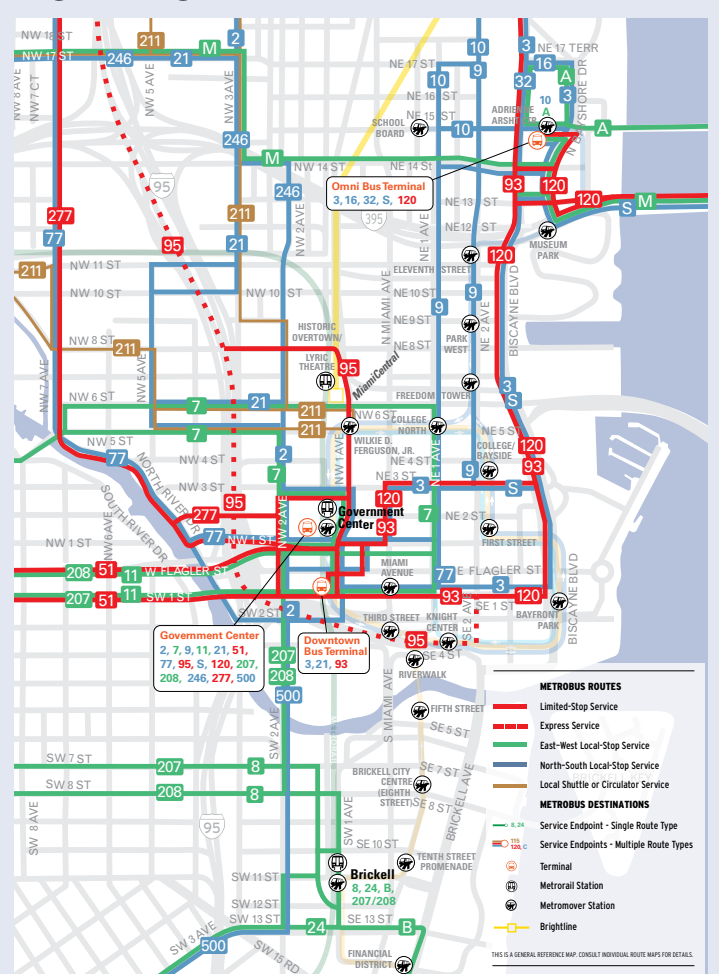

- Connects with MetroRail
- Serves Park & Ride Lot
- Overnight Service
- Serves Miami International Airport
- Connects with Tri-Rail
- Connects with Brightline

- 1 Perrine ↔ Quail Roost Dr/SW 117 Ave
- 2 163 St Mall, 84 St ↔ Downtown Miami
- 3 Aventura Mall ↔ Downtown Miami
- 7 Dolphin Mall, Miami Intl Airport ↔ Downtown Miami
- 8 FIU Maidique Campus ↔ Brickell MetroRail
- 9 Aventura, 163 St Mall ↔ Downtown Miami
- 10 SkyLake Mall ↔ Omni Metrobus Terminal
- 11 FIU Maidique Campus, Mall of the Americas ↔ Downtown Miami
- 12 Northside MetroRail ↔ Mercy Hospital
- 16 163 St Mall ↔ Omni Metrobus Terminal
- 17 Norwood ↔ Vizzaya MetroRail
- 19 (WEEKDAYS ONLY) MDC North Campus ↔ 163 St Mall
- 21 Northside MetroRail ↔ Downtown Miami
- 22 163 St Mall ↔ Coconut Grove MetroRail
- 24 CORAL WAY LIMITED - West Dade ↔ Brickell MetroRail
- 27 Miami Gardens ↔ Coconut Grove MetroRail
- 29 (WEEKDAYS ONLY) Miami Lakes Education Center ↔ Hialeah
- 31 BUSWAY LOCAL - South Dade Government Center ↔ Dadeland South MetroRail
- 32 Carol City ↔ Omni Metrobus Terminal
- 33 Hialeah ↔ NE 79 St/Biscayne Blvd
- 34 EXPRESS (WEEKDAY RUSH-HOUR ONLY) Florida City ↔ Dadeland South MetroRail
- 35 MDC Kendall Campus ↔ Florida City
- 36 Dolphin Mall, Doral, Miami Springs ↔ Midtown Miami
- 37 Hialeah ↔ South Miami MetroRail
- 38 BUSWAY MAX Dadeland South MetroRail ↔ Florida City
- 39 EXPRESS (WEEKDAY RUSH-HOUR ONLY) S Dade Govt Ctr ↔ Dadeland South MetroRail
- 40 Lakes of the Meadow, Tamiami Trail/SW 132 Ave ↔ Douglas Road MetroRail
- 42 Opa-locka Tri-Rail ↔ Douglas Road MetroRail
- 46 LIBERTY CITY CONNECTION (WEEKDAY RUSH-HOUR ONLY) Brownsville MetroRail ↔ Seventh Avenue Transit Village
- 51 FLAGLER MAX (WEEKDAYS ONLY) West Dade ↔ Downtown Miami
- 52 Dadeland South MetroRail ↔ South Dade Health Center
- 54 Miami Gardens Dr/NW 87 Ave, Hialeah Gardens ↔ Biscayne Blvd/NE 54 St
- 56 (WEEKDAYS ONLY) West Dade ↔ Miami Children's Hospital
- 57 (WEEKDAYS ONLY) Miami Intl Airport ↔ Jackson South Hospital
- 62 Hialeah ↔ Biscayne Blvd / 62 St
- 71 Dolphin Mall ↔ MDC Kendall Campus
- 72 West Kendall Terminal, Miller Square ↔ South Miami MetroRail
- 73 Miami Gardens Dr & NW 73 Ave Park & Ride ↔ Dadeland South MetroRail
- 75 Miami Lakes Educational Center ↔ FIU Biscayne Bay Campus
- 77 Norwood ↔ Downtown Miami
- 79 79 STREET MAX (WEEKDAY RUSH-HOUR ONLY) Northside MetroRail ↔ 72 St / Miami Beach
- 82 WESTCHESTER CIRCULATOR (NO SUNDAYS) FIU Maidique Campus ↔ Flagami
- 87 Palmetto MetroRail, Doral ↔ Dadeland North MetroRail
- 88 Dadeland North MetroRail ↔ West Kendall Terminal
- 93 BISCAYNE MAX (WEEKDAYS ONLY) Downtown Miami ↔ Aventura Mall
- 95 EXPRESS GOLDEN GLADES (WEEKDAY RUSH-HOUR ONLY) Carol City, Aventura Mall, Golden Glades ↔ Downtown Miami, Civic Center
- 95 EXPRESS DADE BROWARD (WEEKDAY RUSH-HOUR ONLY) ROUTE 195: Broward Blvd ↔ Downtown Miami
- ROUTE 196: Sheridan St ↔ Downtown Miami
- ROUTE 295: Broward Blvd ↔ Civic Center
- ROUTE 296: Sheridan St ↔ Civic Center
- 99 Miami Gardens Dr & NW 73 Ave Park & Ride ↔ Aventura Mall
- A ROUTE 101: Omni ↔ 20th Street & West Avenue / Miami Beach
- B ROUTE 102: Brickell MetroRail ↔ Key Biscayne
- C ROUTE 103: South Beach ↔ Mt. Sinai Medical Center
- 104 West Kendall Terminal ↔ Dadeland North MetroRail
- E ROUTE 105: Golden Glades ↔ Hallandale Beach
- G ROUTE 107: 94 St / Miami Beach ↔ MDC North Campus
- H ROUTE 108: 163 Street Mall ↔ Haulover Park
- J ROUTE 110: Miami Intl Airport ↔ 41 St / Miami Beach
- L ROUTE 112: Lincoln Rd ↔ Hialeah MetroRail
- M ROUTE 113: Civic Center ↔ Mt. Sinai Hospital
- 115 MID-NORTH BEACH CONNECTION - Collins Ave / 88 St ↔ Lincoln Rd
- S ROUTE 119: Downtown Miami ↔ Aventura Mall
- 120 BEACH MAX Downtown Miami ↔ Haulover Park, Aventura Mall
- 132 TRI-RAIL DORAL SHUTTLE (WEEKDAY RUSH-HOUR ONLY): Doral ↔ Hialeah Market Tri-Rail
- 135 Hialeah MetroRail, Miami Lakes ↔ FIU Biscayne Bay Campus
- 136 (WEEKDAY RUSH-HOUR ONLY) SW 136 St / US1 ↔ Douglas Road MetroRail
- 137 WEST DADE CONNECTION Dolphin Mall ↔ South Dade Gov Center
- 150 MIAMI BEACH AIRPORT EXPRESS Miami Intl Airport ↔ South Beach
- 155 BISCAYNE GARDENS CIRCULATOR (WEEKDAYS ONLY)
- 183 Miami Gardens Dr & NW 73 Ave Park & Ride ↔ Aventura Mall
- 200 CUTLER BAY LOCAL
- 202 LITTLE HAITI CONNECTION Biscayne Shopping Plaza, NW 5 Ave / 83 St ↔ Miami Design District
- 204 KILLIAN KAT (WEEKDAY RUSH-HOUR ONLY) West Kendall Terminal ↔ Dadeland North MetroRail
- 207 LITTLE HAVANA CONNECTION (CLOCKWISE) Downtown Miami, Brickell ↔ SW 25 Ave via SW 1 St & SW 7 St
- 208 LITTLE HAVANA CONNECTION (COUNTERCLOCKWISE) Downtown Miami, Brickell ↔ SW 27 Ave via W Flagler St & S1
- 210 SKYLAKE CIRCULATOR SkyLake Mall ↔ 163 Street Mall
- 211 OVERTOWN CIRCULATOR (WEEKDAYS ONLY)
- 212 SWEETWATER CIRCULATOR (WEEKDAYS ONLY)
- 217 BUNCHE PARK CIRCULATOR (WEEKDAYS ONLY) NW 127 St / 22 Ave ↔ N Dade Health Center
- 238 EAST-WEST CONNECTION (WEEKDAYS ONLY) Dolphin Mall ↔ Miami Int. Airport
- 246 NIGHT OWL Downtown Miami ↔ 163 St Mall
- 248 PRINCETON CIRCULATOR Southland Mall ↔ SW 264 St, Naranja (Weekdays Only)
- 252 CORAL REEF MAX Country Walk ↔ Dadeland South MetroRail, Zoo Miami (Weekends Only)
- 254 BROWNSVILLE CIRCULATOR (WEEKDAYS ONLY) Caleb Center ↔ Jefferson Reeves Park, Hialeah (Thursday only)
- 267 LUDLAM LIMITED (WEEKDAY RUSH-HOUR ONLY) NW 186 St/87 Ave ↔ Okeechobee MetroRail
- 272 SUNSET KAT (WEEKDAY RUSH-HOUR ONLY) West Kendall Terminal ↔ Dadeland North MetroRail
- 277 NW 7 AVENUE MAX (WEEKDAY RUSH-HOUR ONLY) Downtown Miami ↔ Golden Glades Park & Ride
- 286 NORTH POINTE CIRCULATOR (NO SUNDAYS) Miami Gardens Dr & NW 73 Ave Park & Ride ↔ NW 57 Ave/NW 176 St
- 287 SAGA BAY MAX (WEEKDAY RUSH-HOUR ONLY) S Dade Health Center ↔ Dadeland South MetroRail
- 288 KENDALL CRUISER (WEEKDAY RUSH-HOUR ONLY) West Kendall Terminal, SW 127 Ave Park & Ride ↔ Dadeland North MetroRail
- 297 27th AVE ORANGE MAX (WEEKDAYS ONLY) Miami Intl Airport ↔ Miami Gardens
- 301 DADE-MONROE EXPRESS Florida City ↔ Marathon Key
- 302 CARD SOUND EXPRESS Florida City ↔ Ocean Reef Club
- 338 WEEKEND EXPRESS (WEEKENDS ONLY) Miami Intl Airport ↔ Dolphin Mall
- 344 (WEEKDAYS ONLY) Florida City ↔ MDC Homestead Campus
- 500 MIDNIGHT OWL Dadeland South MetroRail ↔ Downtown Miami

DRIVE LESS. LIVE MORE.™

www.miamidade.gov/transit 311 (305.468.5900) TTY/FLORIDA RELAY: 711

@GoMiamiDade MDT TRACKER / EASY PAY MIAMI / MDT TRANSIT WATCH



## APPENDIX F

---

Recent & Future Approved and Funded Transportation Projects:  
    FDOT 5-year Work Program  
    Miami-Dade Long Range Transportation Plan  
    FDOT's Correspondence Tracking Program  
    Project Suite



Florida Department of

# TRANSPORTATION

[E-Updates](#) | [FL511](#) | [Site Map](#) | [Translate](#)



- [Home](#)
- [About FDOT](#)
- [Contact Us](#)
- [Maps & Data](#)
- [Offices](#)
- [Performance](#)
- [Projects](#)

## Web Application

### Office of Work Program and Budget Lisa Saliba - Director

#### Five Year Work Program

Selection Criteria	
All in State (Updated: 1/15/2020-21.15.01)	2020-2025 G1 Item Number:446001-1

Scheduled Activities may or may not be confirmed dates and are subject to change without notice.  
Please contact the Program Services Office at the appropriate [District office](#) for validation.

446001-1 SR 976/BIRD ROAD/SW 40 ST FROM E OF LAGUNA ST TO WEST OF SW 38 AVE  
District 06 - Miami-Dade County **Project Manager: SOLAUN, JUDY**

**Type of Work:** RESURFACING

Activity	Description	Planned Start	Planned Finish
164010000	PREPARE SCOPE OF WORK	02/08/2021	06/10/2021
106010000	DESIGN SURVEY	06/21/2021	Fiscal Year: 2022
232010000	DESIGN CONSULTANT ADVERTISE	Fiscal Year: 2022	Fiscal Year: 2022
233010000	P.E. CONTRACT EXECUTED	Fiscal Year: 2022	Fiscal Year: 2022
234010000	NOTICE TO PROCEED	Fiscal Year: 2022	Fiscal Year: 2022
113010000	ROADWAY PLANS	Fiscal Year: 2022	Fiscal Year: 2024
264010000	UTILITY CONTACT	Fiscal Year: 2022	Fiscal Year: 2022
260010000	TYPICAL SECTION APPROVED	Fiscal Year: 2023	Fiscal Year: 2023
302010000	PHASE II PLANS REVIEW	Fiscal Year: 2023	Fiscal Year: 2023
750010000	WETLAND REPORT	Fiscal Year: 2023	Fiscal Year: 2024
302010100	PHASE II PLANS REVIEW	Fiscal Year: 2023	Fiscal Year: 2023
302010200	PHASE II PLANS REVIEW	Fiscal Year: 2023	Fiscal Year: 2023
303010000	PHASE III PLANS REVIEW	Fiscal Year: 2023	Fiscal Year: 2023
303010100	PHASE III PLANS REVIEW	Fiscal Year: 2023	Fiscal Year: 2023

303010200	PHASE III PLANS REVIEW	Fiscal Year: 2023	Fiscal Year: 2023
310010000	PHASE IV PLANS REVIEW	Fiscal Year: 2023	Fiscal Year: 2023
310010100	PHASE IV PLANS REVIEW	Fiscal Year: 2023	Fiscal Year: 2024
756010000	SECTION 106 EFFECTS/ 267 F.S.	Fiscal Year: 2023	Fiscal Year: 2024
201010000	PLANS COMPLETED	Fiscal Year: 2024	Fiscal Year: 2024
204010000	PRODUCTION DATE	Fiscal Year: 2024	Fiscal Year: 2024
255010000	R/W CERTIFIED	Fiscal Year: 2024	Fiscal Year: 2024
222010000	ALL PERMITS CLEAR	Fiscal Year: 2024	Fiscal Year: 2024
269010000	ALL UTILITIES CLEAR	Fiscal Year: 2024	Fiscal Year: 2024
375010000	CONSTRUCTION CLEAR DATE	Fiscal Year: 2024	Fiscal Year: 2024
376010000	ENVIRONMENTAL CLEAR/CERTIF	Fiscal Year: 2024	Fiscal Year: 2024
355010000	NMSA (NON MAJOR STATE ACTION)	Fiscal Year: 2024	Fiscal Year: 2024
279010000	RAILROAD CLEAR	Fiscal Year: 2024	Fiscal Year: 2024
226010000	PLANS TO DIST SPECS	Fiscal Year: 2024	Fiscal Year: 2024
242010000	SPECIFICATIONS	Fiscal Year: 2024	Fiscal Year: 2024
370010000	PLANS TO DIST CONTRACT	Fiscal Year: 2024	Fiscal Year: 2024
229010100	ADVERTISE DISTRICT CONTRACT	Fiscal Year: 2024	Fiscal Year: 2024
280010000	LETTING DATE	Fiscal Year: 2024	Fiscal Year: 2024
203010000	C.E.I. CONS. CONT. EXEC.	Fiscal Year: 2024	Fiscal Year: 2024

---

This site is maintained by the Office of Work Program and Budget, located at 605 Suwannee Street, MS 21, Tallahassee, Florida 32399.

For additional information please e-mail questions or comments to:  
Office of Work Program and Budget  
Lisa Saliba: [Lisa.Saliba@dot.state.fl.us](mailto:Lisa.Saliba@dot.state.fl.us) Or call 850-414-4622

[View Contact Information for Office of Work Program and Budget](#)

**Application Home:** [Work Program](#)  
**Office Home:** [Office of Work Program and Budget](#)

- [Contact Us](#)
- [Employment](#)
- [MyFlorida.com](#)
- [Performance](#)
- [Statement of Agency](#)
- [Web Policies & Notices](#)



© 1996-2019 Florida Department of Transportation

Florida Department of Transportation

**Consistent, Predictable, Repeatable**



SEPTEMBER 26, 2019

MIAMI-DADE  
TRANSPORTATION PLANNING ORGANIZATION

2045

LONG  
RANGE  
TRANSPORTATION  
PLAN



## 2019 CMP PROJECTS

Figure 7-3 and Table 7-10 present a map and list of congestion management plan projects for Miami-Dade County for the period 2025 to 2035, respectively.

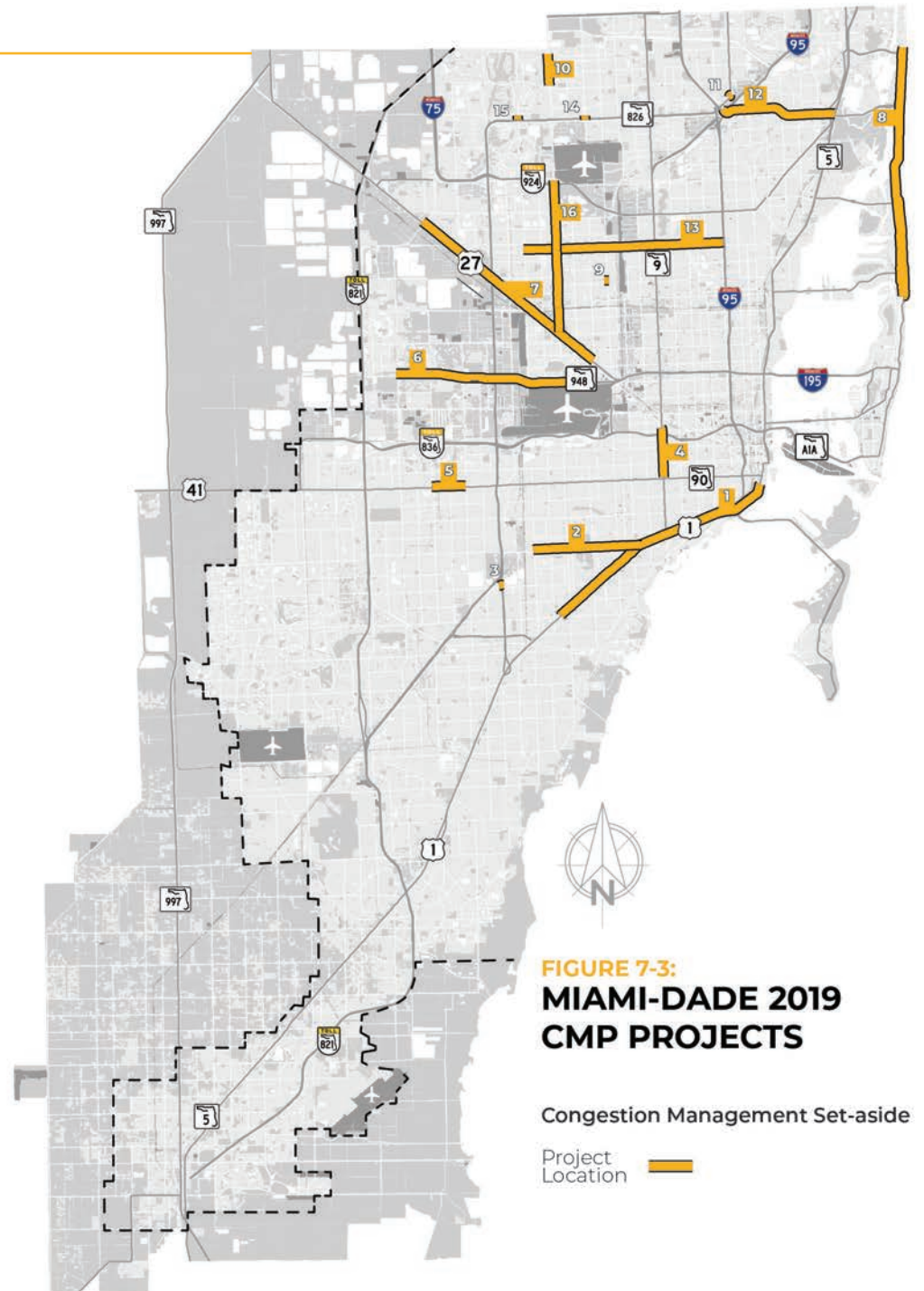

TABLE 7-10: MIAMI-DADE 2019 CMP PROJECTS

MAP ID	FACILITY	LIMITS FROM	LIMITS TO	STRATEGIES*	SUMMARY DESCRIPTION	PLAN PERIOD I: 2020-2025	PLAN PERIOD II: 2026-2030	PLAN PERIOD III: 2031-2035	TOTAL 2045 PLAN (YOE \$)
PM1	1	US 1 (South Dixie Hwy/SR 5)	SW 72 St (Sunset Dr)	SE 13 St	4.6	Install Fiberoptic Communications for Traffic Surveillance and Control Systems	\$5.500	\$2.500	\$8.000
	2	SW 40 St (Bird Rd/SR 976)	Ludlam Rd (SW/NW 67 St)	US 1 (South Dixie Hwy/SR 5)	1.4	Bus Rapid Transit		\$9.800	\$9.800
PM1	3	SW 56 St (Miller Dr)	SR 826 (Palmetto Expy)		2.0 4.1 5.5	Travel Demand Management Traffic Signal Coordination and Modernization Highway Widening by Adding lanes		\$2.500	\$2.500
PM1	4	SR 9 (NW 27 Ave)	SW 8 St (Tamiami Trail/SR 90/US 41)	NW 14 St	4.1	Traffic Signal Coordination and Modernization	\$1.500		\$1.500
	5	SW 8 St (Tamiami Trail/SR 90/US 41)	SW 97 Ave	SR 973 (SW 87 Ave)	2	Travel Demand Management	\$0.300		\$0.300
	6	SR 948 (NW 36 St/ NW 41 St/ Doral Blvd)	NW 107 Ave	East Dr	1.5 1.8 2.0	Increasing Bus Route Coverage or Frequencies Local Circulator Expansion Travel Demand Management	\$0.300	\$2.100	\$2.400
PM3	7	US 27/Okeechobee Rd (SR 25)	West Hialeah Gardens Blvd	SE 4 Ave	2.0 4.1 5.5	Travel Demand Management Traffic Signal Coordination and Modernization Highway Widening by Adding lanes	\$0.300	\$9.500	\$9.800
PM1	8	SR A1A	SR 907/West 63 St	SR 856 (William Lehman Causeway)/ NW 192 Ave	3.1 3.5	Adopt and implement a Complete Streets Policy Improved Safety of Existing Bicycle and Pedestrian Facilities	\$1.450	\$2.600	\$4.050
PM1	9	East 33 St	at SR 953 /East 8 Ave/ Le Jeune Rd		3.6 3.1 3.2 3.3 3.5	Promote Bicycle and Pedestrian Use Adopt and implement a Complete Streets Policy New Sidewalks and Designated Bicycle Lanes on Local Streets Improved Bicycle Facilities at Transit Stations and Other Trip Destinations Improved Safety of Existing Bicycle and Pedestrian Facilities	\$0.240	\$0.720	\$0.960
PM1	10	FL 823/SW 57 Ave (Red Rd/SR 959)	SR 860 (Miami Gardens Dr) /NW 183 St	NW 199 St/NE 203 St (Ives Dairy Rd)	2.0 4.1	Travel Demand Management Traffic Signal Coordination and Modernization		\$1.900	\$1.900
PM1	11	NW 7 Ave (SR 7/ US 441) Extension	at US 441		1.5 2.0 4.1	Increasing Bus Route Coverage or Frequencies Travel Demand Management Traffic Signal Coordination and Modernization		\$2.300	\$2.300
PM1	12	SR 826 (Palmetto Expy)/NE 167 St/ Miami Beach Blvd	I-95 (SR 9)	US 1 (South Dixie Hwy/SR 5)	1.4 1.8 2.0 3.2 3.3 3.5 3.6	Bus Rapid Transit Local Circulator Expansion Travel Demand Management New Sidewalks and Designated Bicycle lanes on Local Streets Improved Bicycle Facilities at Transit Stations and Other Trip Destinations Improved Safety of Existing Bicycle and Pedestrian Facilities Promote Bicycle and Pedestrian Use		\$6.600	\$6.600

\*Project does not comply with the CDMP.

Values in Millions YOE \$  
YOE: Year of Expenditure



**SCOPE OF SERVICES  
TASK WORK ORDER  
DISTRICTWIDE TRAFFIC OPERATIONS STUDIES CONTRACT**

**TASK WORK ORDER NUMBER 126 – BOTTLENECK ANALYSIS  
SR 976/SW 40<sup>TH</sup> STREET/BIRD ROAD AT SR 953/SW 42<sup>ND</sup> AVENUE/LE JEUNE ROAD**

**Financial Project Number 249726-4-32-01  
Contract C-9G07**

**1.0 BACKGROUND:**

Kimley-Horn and Associates, Inc. (Kimley-Horn) has been retained by the Florida Department of Transportation (FDOT) to conduct a Bottleneck Analysis of intersections identified. These intersections typically exhibit severe congestion and were prioritized by the District for future study in the *D6 Bottleneck & Prioritization* report, dated June 2018. The intent of the bottleneck study is to analyze the existing conditions of the intersection; assess the secondary congestion caused by the intersection; and evaluate potential short term, low cost treatments that reduce the duration and intensity of the congestion while improving mobility through the intersection.

The identified intersection of SR 976/SW 40th Street/Bird Road at SR 953/SW 42nd Avenue/Le Jeune Road (see Figure 1) is based on the District's bottleneck intersection list and its bottleneck analysis methodology, dated August 10, 2018. Consistent with that methodology, the bottleneck analysis will focus on the AM peak period of a typical weekday and will include Synchro analysis and traffic microsimulation (VISSIM). Limited level of service (LOS) analysis (Synchro only) will also be conducted for the PM peak hour to check that recommendations resulting from the AM study do not adversely impact traffic operations in the PM peak hour.

For the intersection of SR 976/SW 40th Street/Bird Road at SR 953/SW 42nd Avenue/Le Jeune Road, it is assumed that the study segment for this bottleneck analysis reflects the corridors defined in the *D6 Bottleneck & Prioritization* report, dated June 2018, which is:

- SR 976/SW 40<sup>th</sup> Street/Bird Road from SW 57<sup>th</sup> Avenue to US 1

For purposes of this task work order, the study area is assumed to be limited to the following intersections:

1. SR 976/SW 40th Street/Bird Road at Riviera Drive
2. SR 976/SW 40th Street/Bird Road at SR 953/SW 42nd Avenue/Le Jeune Road
3. SR 976/SW 40th Street/Bird Road at Ponce de Leon Boulevard

If it is later determined that other intersections should be incorporated in the study area, a supplemental task work order will be prepared, at the discretion of the FDOT, for expanding the scope of the bottleneck study.

**2.0 SCOPE:**

The study shall incorporate tasks described below.

**a. Data Collection**

The Consultant shall utilize the data collected in the *D6 Bottleneck & Prioritization* report, dated June 2018. This data includes travel time runs, spot speed data, and intersection turning movement counts. The

Consultant shall augment this existing data with 6-hour turning movement counts (4 hours AM peak + 2 hours PM peak) at the following intersections:

1. SR 976/SW 40th Street/Bird Road at Riviera Drive
2. SR 976/SW 40th Street/Bird Road at SR 953/SW 42nd Avenue/Le Jeune Road
3. SR 976/SW 40th Street/Bird Road at Ponce de Leon Boulevard



The Consultant shall also obtain the current signal timing plans from Miami-Dade County's Traffic Signals and Signs (TS&S) division for the study intersection. In addition, transit service data including routes, stops, headways, and travel times and speeds will be gathered within the study area.

#### **b. Field Review**

The Consultant shall conduct field reviews of the study area and intersections to verify physical and operational characteristics required for the analysis. These characteristics include lane geometry, signal timings, speed limits, operational restrictions, and field operations at the study intersections. The field review will also estimate maximum queue lengths for each approach and movement of the study intersections within each 60-minute period of the entire 4-hour AM peak period. A field review shall also be conducted to assess typical traffic operating conditions during the PM peak period.

#### **c. Synchro Traffic Operations Analysis**

The Consultant shall develop an existing conditions Synchro network for the following study intersections:

1. SR 976/SW 40th Street/Bird Road at Riviera Drive
2. SR 976/SW 40th Street/Bird Road at SR 953/SW 42nd Avenue/Le Jeune Road
3. SR 976/SW 40th Street/Bird Road at Ponce de Leon Boulevard

This existing conditions peak hour analysis will be prepared for the four (4) 60-minute periods between 6:00 am and 10:00 am for the 4-hour AM peak and one (1) 60-minute period during the PM peak. The analysis will incorporate the signal timing plans that exist within the entire four (4)-hour AM peak period and one (1) hour during the PM peak. Synchro models will also be developed, as needed, to provide preliminary screening of potential improvements.

The final analysis will be prepared based on Synchro 10 software, and measures of effectiveness will include LOS, queue lengths, and vehicular delay. These measures will be reported for each approach of each intersection, as well as for the overall intersection. The signal timings from the Synchro network will be utilized by a subsequent VISSIM model analysis.

**d. VISSIM Analysis**

The following intersections will be included in the VISSIM transportation model:

1. SR 976/SW 40th Street/Bird Road at Riviera Drive
2. SR 976/SW 40th Street/Bird Road at SR 953/SW 42nd Avenue/Le Jeune Road
3. SR 976/SW 40th Street/Bird Road at Ponce de Leon Boulevard

The intersections required to be evaluated in this analysis will be analyzed for i.) existing conditions and ii.) short-term build alternative utilizing PTV America's *VISSIM* software.

**d.1 – Existing Conditions VISSIM Analysis**

PTV America's *VISSIM* software will be utilized to develop the transportation model for existing conditions. The VISSIM analysis will be prepared for the A.M. peak period from 6:00 AM to 10:00 AM. The VISSIM model will include intersection and roadway geometry, traffic volumes, traffic control, speed limits, vehicle turning speeds, vehicle routing, priority rules, and conflict areas. Error-checking techniques will be utilized to review the transportation model input coding.

The existing conditions VISSIM model will be calibrated to local traffic conditions observed in the field. Calibration measures will consist of field-verified signal timings, travel times provided by FDOT, and vehicle speed distributions.

**d.2 – Short-term Build Alternative VISSIM Analysis**

A short-term build alternative transportation model will be prepared utilizing PTV America's *VISSIM* software for the peak period identified as part of Task d.1. Short-term improvements are expected to consist of Transportation Systems Management and Operations (TSM&O) strategies, turn-lane improvements, pavement marking/laneage modifications, and/or signal timing modifications.

**d.3 – Measures of Effectiveness (MOE) Evaluation**

Vehicular operating conditions will be examined for each model scenario to evaluate the measures of effectiveness (MOEs) consisting of maximum queue length, average vehicle delay, travel time, average vehicle speed, volume, lost time, and green time distribution at the study intersections approaches (node evaluation) and roadway segments (link evaluation). MOEs will be summarized in a table and may include intersection levels of service which can be derived based on the average vehicle delay at each intersection (node).

Note that VISSIM MOEs are not able to be compared directly to Synchro results as VISSIM MOEs are stochastic and are not based specifically on the Transportation Research Board's (TRB) *Highway Capacity Manual* (HCM).

**d.4 – Independent Review**

An independent review of the existing and short-term conditions VISSIM models will be conducted by a staff member that was not involved in preparing the VISSIM transportation models.

**e. Conceptual Improvement Development**

A conceptual plan depicting the recommended improvements identified in Task d.2 will be developed for the study intersections to address bottleneck deficiencies. The short-term improvements are expected to consist of TSM&O strategies, turn-lane improvements, and/or pavement marking/laneage modifications. The conceptual plan shall be prepared in CAD format.

Notes: (1) Kimley-Horn shall rely on right-of-way (R/W) information provided by FDOT. If none is available R/W lines shall be approximated based on a review of aerials and field observations.  
(2) Kimley-Horn shall rely on utility information provided by FDOT. If none is available utilities shall be approximated based on a review of Google Streetview.

**f. Documentation**

The results of the analyses will be documented in a technical memorandum. The memorandum will include graphics and tabulations, plus text to describe the study procedure, key assumptions, traffic assignment methods, findings and recommendations. The Consultant shall respond to one (1) round of comments from the Client.

**Deliverables**

1. Draft Technical Memorandum (Three hard copies and in PDF Format)
2. Final Technical Memorandum (Three hard copies signed and sealed and in PDF Format)
3. One (1) Conceptual Plan in CAD format

**4.0 CONSULTANT RESPONSIBILITIES:**

The Consultant's responsibilities remain the same as in the Original Agreement and any Supplemental Amendments to date shall remain the same.

**5.0 DEPARTMENT RESPONSIBILITIES:**

The Department's responsibilities remain the same as in the Original Agreement and any Supplemental Amendments to date shall remain the same.

**6.0 ADDITIONAL SERVICES:**

Any services not specifically provided for in the above scope will be considered additional services and can be performed through an amendment to the task work order.

**7.0 METHOD OF COMPENSATION:**

Services for this work order will be provided on a lump sum basis based on percentage of completion in accordance with provisions set forth in the master contract. The lump sum amount for this work order is \$48,585.53.

**District 6 Districtwide Traffic Operations Studies - Kimley-Horn and Associates, Inc.**

FDOT Contract No.: 249726-4-32-01  
 C9G07  
 Task Work Order No.: 126  
 Task Description: Bottleneck Analysis - SR 976/Bird Road at SR 953/Le Jeune Road  
 County: Miami-Dade  
 Draft Report Due: 9/16/19  
 Final Report Due: 10/14/19

ACTIVITY	PROJECT MANAGER		SENIOR ENGINEER		PROJECT ENGINEER		ENGINEER		ENGINEER INTERN		CLERICAL		STAFF HOURS TOTAL	BASIC ACTIVITIES TOTAL	FIXED FEE DM RATE TOTALS
	Hourly Rate	Fixed Fee DM	Hourly Rate	Fixed Fee DM	Hourly Rate	Fixed Fee DM	Hourly Rate	Fixed Fee DM	Hourly Rate	Fixed Fee DM	Hourly Rate	Fixed Fee DM			
Project Management													5	\$762.52	\$68.48
Data Collection	\$172.02	\$15.45	\$196.18	\$17.43	\$138.71	\$12.46	\$103.72	\$9.31	\$89.20	\$8.01	\$74.44	\$6.68	3	\$449.44	\$40.37
Review Data Collection					2										
Field Review															
4 hours AM & 1 hour PM					6								19	\$2,074.68	\$186.33
Synchro Analysis - 3 Intersections															
4 hours AM, 1 hour PM - Existing and Build					24								40	\$5,087.52	\$456.96
VSSIM Analysis - 3 Intersections															
4 hours AM - Existing and Build			20		15		40		100				179	\$19,721.13	\$1,770.70
Conceptual Improvement Development - 3 Intersections									40				66	\$7,374.32	\$662.30
Prepare CDs			6		20								2	\$4,998.26	\$448.96
Documentation													16	\$2,224.06	\$199.76
Draft			4		30								36	\$4,998.26	\$448.96
Final			4		10								16	\$2,224.06	\$199.76
TOTALS	\$4,816.56	\$432.60	\$3,883.60	\$348.60	\$14,841.97	\$1,333.22	\$4,148.80	\$372.40	\$14,628.80	\$1,313.64	\$372.20	\$33.40	364.00	\$42,691.93	\$3,833.86

Notes:

Data Collection Activities and Total Fees

Caliban - 8 Hour TMCs - 3 Intersections

\$2,059.74

TOTAL TASK WORK ORDER LUMP SUM FEE:

\$48,585.53

Department Approval:

KHALIL MABROUF  
(Project Manager)

K. MAABROUF  
(Signature)

5/30/2019  
(Date)

Consultant Approval:

John J. McWilliams, P.E.  
(Vice President)

[Signature]  
(Signature)

5/29/19  
(Date)





# Florida Department of Transportation

RICK SCOTT  
GOVERNOR

3222 P Y "333th Cxgpwg"  
O lco k "Florida 55394-5800

JIM BOXOLD  
SECRETARY

## O GO QTC P F WO "

F cvg<"05/30/2019

Vq<" Professional Services

Htqo <"Khalil Maarouf

Uwdlgev<"Vcunl'Y qtnl'Qtf gt'Egtvhlcvkp"

Eqptcev'P wo dgt<"C9G07

Vcunl'Y qtnl'Qtf gt<"126

Y qtnl'F guetkr vqpc < SW 40 Street/ Bird Road at LeJeune Road. Bottleneck Analysis

"  
Kp"ceeqtf cpeg'y kj 'F gr ctvo gpv'Rtqegf wtg'597/252/232.'Kj gtgd { 'egtvh { 'vj cv'cp'lpf gr gpf gpv'  
cuuguo gpv'qh'vj g'uclh'j qwtu'cpf 's wcpv'kgu'hqt'vj g'r tqr qugf 'ugtx'legu'j cu'dggp'r gthqto gf "cpf "  
hqwpf "q'dg'hck."eqo r g'k'kg."cpf 'tgcupcdrg."gzeqr v'y j gt g'vj g'hggu'hqt'vj g'vcunl'ctg'crtgcf { "  
ur gekhg'kp'vj g'qtki kpcn'ci tggo gpv'  
"

Cml'hggul'uj qy p'kp'vj g'uwdlgev'Vcunl'Y qtnl'Qtf gt'ctg'lp'ceeqtf cpeg'y kj 'vj g'eqptcewcn'ci tggo gpv'

"  
" DocuSigned by:  
Khalil Maarouf  
Rtqlgev'Opert Department

Project info [434766.1] (Click to collapse)

Item Segment (Click to collapse)

<b>District:</b> District 6	<b>Version:</b> G1	<b>PSEE Project Manager:</b> Ana Arvelo MIGUEL IGLESIAS (Backup) Favio Laverde (Backup)	<b>WP Project Manager:</b> ARVELO, ANA
--------------------------------	-----------------------	--	---

**Item Segment Description:** SR 953/LEJEUNE ROAD AT SR 976/BIRD RD (EASTBOUND/WESTBOUND APPROACHES)

**Item Segment Comments:** SAFETY PROJECT TO PROVIDE BACKPLATES ON SIGNAL HEADS/#E- ON EB & WB APPROACH, OFFSET EB & WB LEFT TURN LANES. PROVIDE ADDITIONAL GREEN TIME FOR WB & EB LEFT TURN PHASES. B/C = 7.2 (ORIGINAL B/C), PH 32-02=CONSTRDL SURVEY ON 4-2-15, B/C UPDATED TO 5.38 NPV=5,965,898, SHSP = "INTERSECTION CRASHES"

Location (Click to collapse)

County	Roadway ID	Roadway Side	Number of Lanes	MP From/To	Section Work Length
MIAMI-DADE	87044000	LEFT RDWY	2	7.682 / 7.74	0.058
	87044000	RIGHT RDWY	2	7.682 / 7.788	0.106
	87044000	LEFT RDWY	3	7.74 / 7.788	0.048

Work Length: 0.106      Project Length: 0.106

Description (Click to collapse)

<b>Work Mix:</b> 0233 - INTERSECTION IMPROVEMENT	<b>Status:</b> LINE ITEM COMPLETED	<b>Contract Class:</b> 1 - TALLAHASSEE LET	<b>Federal Oversight:</b> NO
---	---------------------------------------	---	---------------------------------

**Trans System:** 03 - INTRASTATE STATE HIGHWAY

**Proposed Bicycle Paths - newlimax4**

**Existing Bicycle Paths and Routes**

**Proposed Bicycle Paths and Routes**

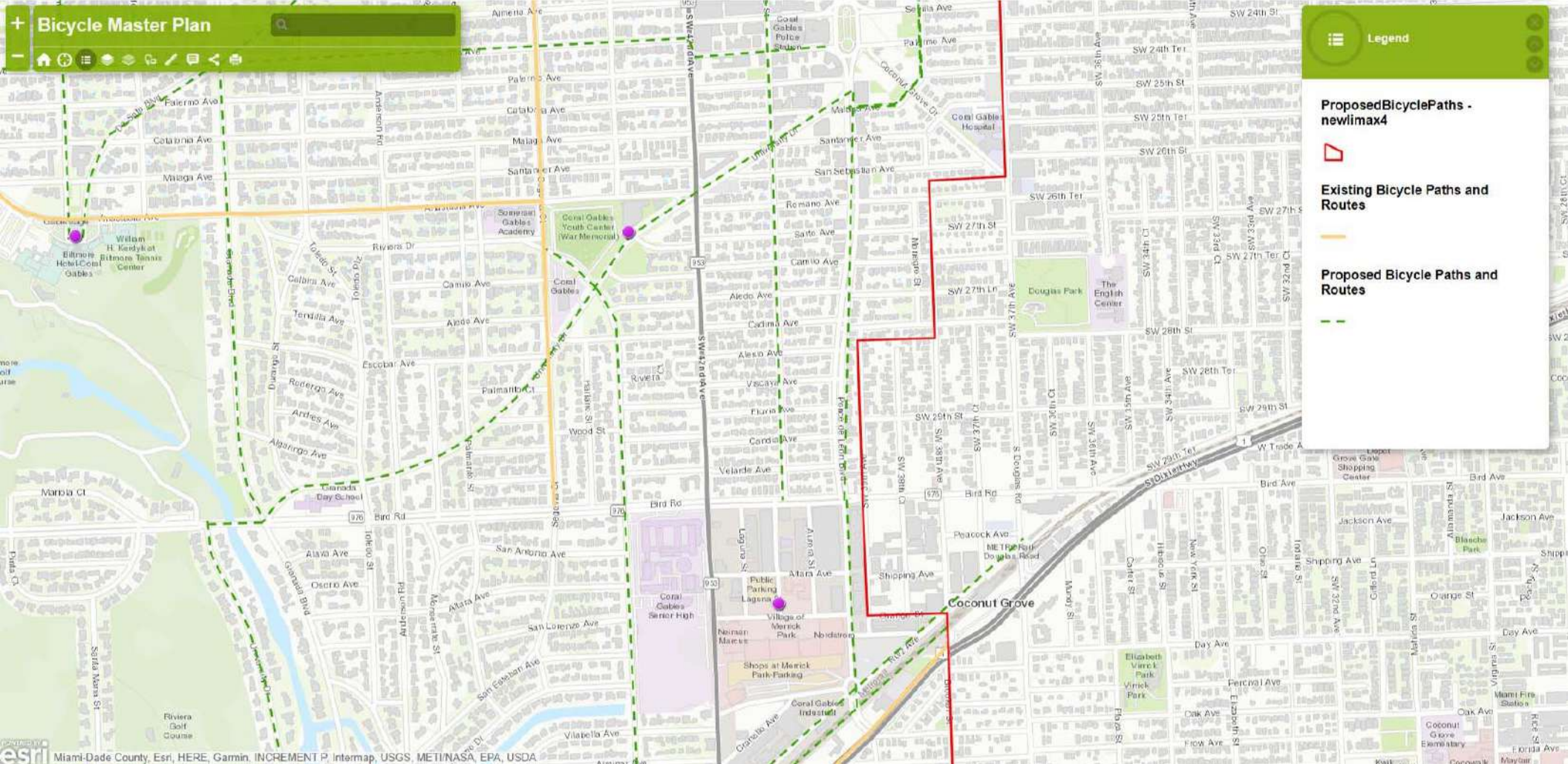

# APPENDIX G

---

## Historic Growth Rate Data and Analysis

## Traffic Trends - V03.a PONCE DE LEON BLVD --

FIN#	1234
Location	3

County:	Miami-Dade (87)
Station #:	878139
Highway:	PONCE DE LEON BLVD

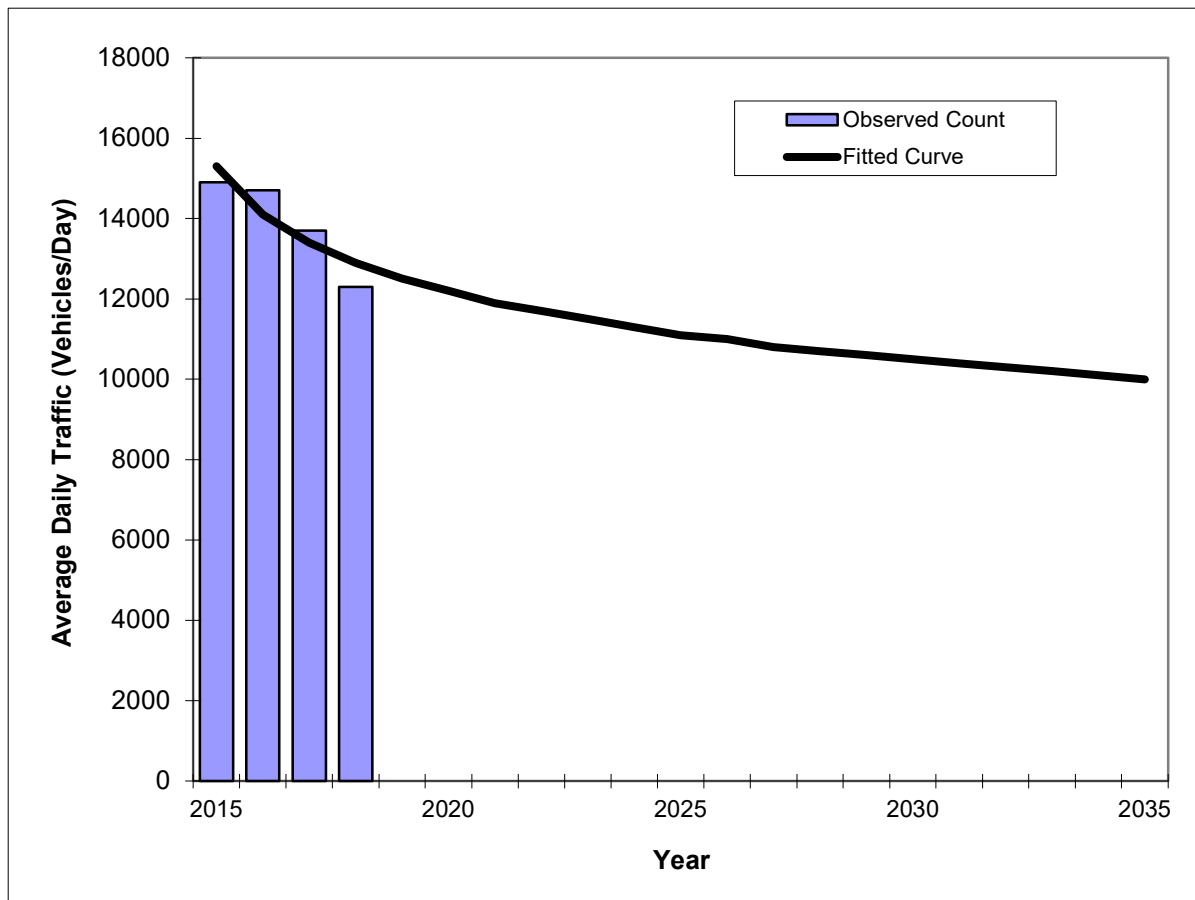

Year	Traffic (ADT/AADT)	
	Count*	Trend**
2015	14900	15300
2016	14700	14100
2017	13700	13400
2018	12300	12900
<b>2022 Opening Year Trend</b>		
2022	N/A	11700
<b>2027 Mid-Year Trend</b>		
2027	N/A	10800
<b>2032 Design Year Trend</b>		
2032	N/A	10300
<b>TRANPLAN Forecasts/Trends</b>		

Trend R-squared:	77.15%
Compounded Annual Historic Growth Rate:	-5.53%
Compounded Growth Rate (2018 to Design Year):	-1.59%
Printed:	27-Jan-20
<b>Decaying Exponential Growth Option</b>	

\*Axle-Adjusted

## Traffic Trends - V03.a LEJEUNE RD/SW 42 AVE --

FIN#	1234
Location	2

County:	Miami-Dade (87)
Station #:	871053
Highway:	LEJEUNE RD/SW 42 AVE

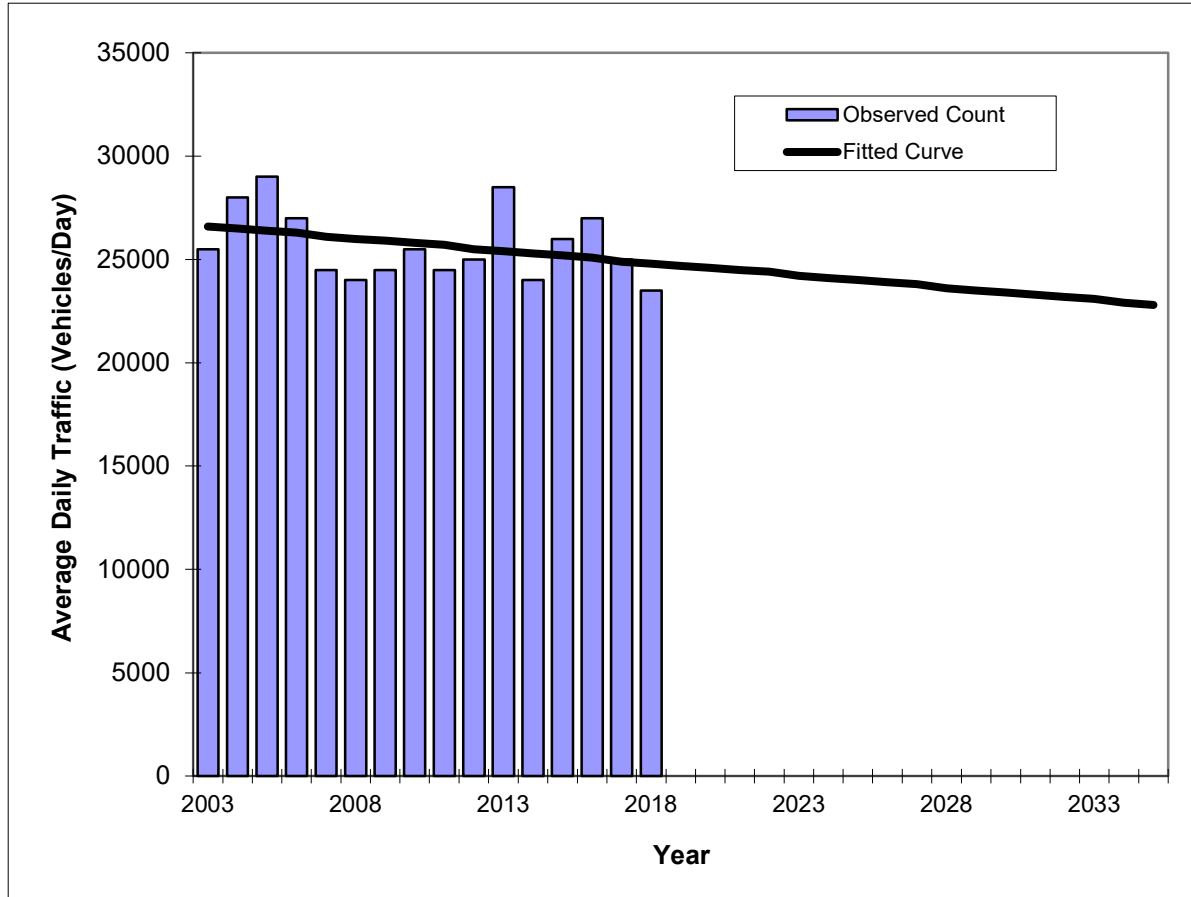

Year	Traffic (ADT/AADT)	
	Count*	Trend**
2003	25500	26600
2004	28000	26500
2005	29000	26400
2006	27000	26300
2007	24500	26100
2008	24000	26000
2009	24500	25900
2010	25500	25800
2011	24500	25700
2012	25000	25500
2013	28500	25400
2014	24000	25300
2015	26000	25200
2016	27000	25100
2017	25000	24900
2018	23500	24800
<b>2022 Opening Year Trend</b>		
2022	N/A	24400
<b>2027 Mid-Year Trend</b>		
2027	N/A	23800
<b>2032 Design Year Trend</b>		
2032	N/A	23200
<b>TRANPLAN Forecasts/Trends</b>		

** Annual Trend Increase:	-118
Trend R-squared:	10.96%
Trend Annual Historic Growth Rate:	-0.45%
Trend Growth Rate (2018 to Design Year):	-0.46%
Printed:	27-Jan-20
<b>Straight Line Growth Option</b>	

\*Axle-Adjusted

# Traffic Trends - V03.a

SW 40 ST/BIRD ROAD --

FIN#	1234
Location	1

County:	Miami-Dade (87)
Station #:	870082
Highway:	SW 40 ST/BIRD ROAD

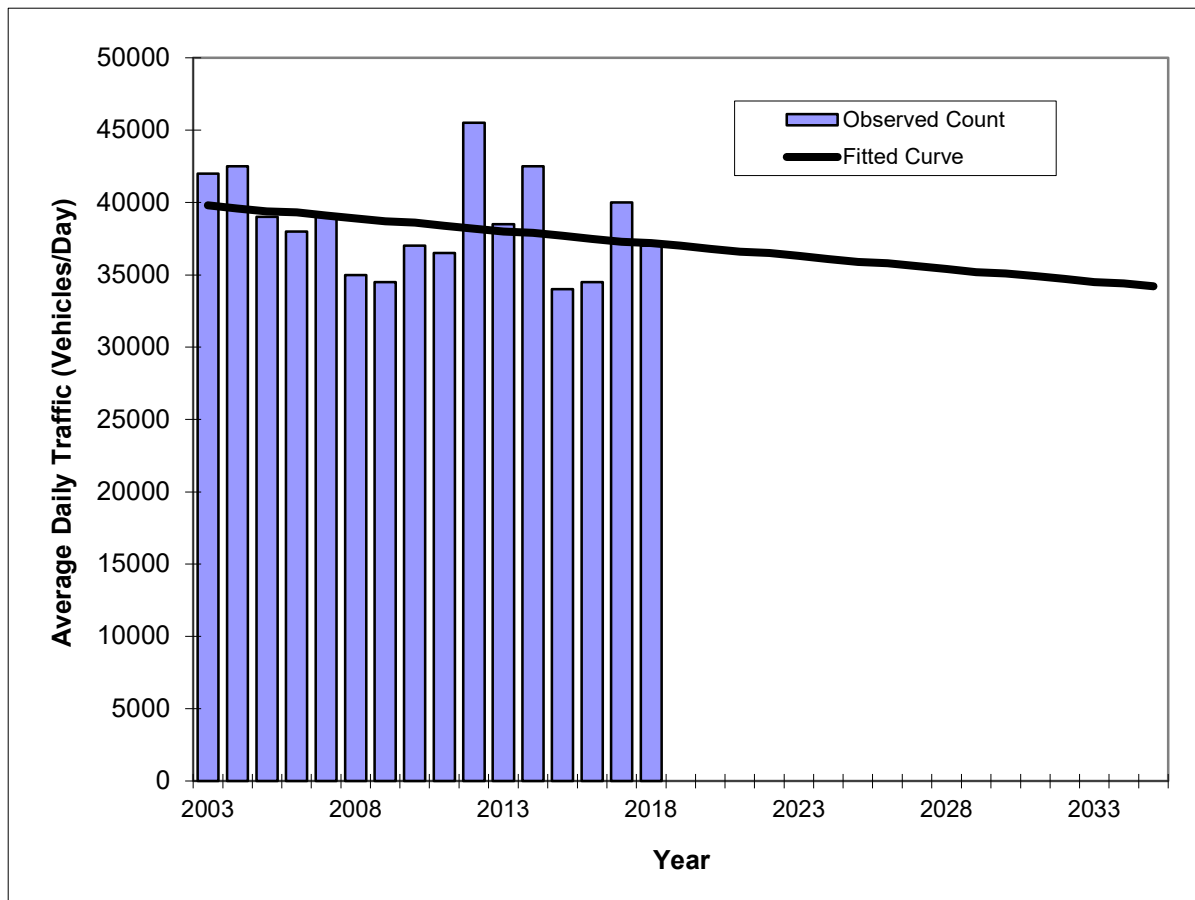

Year	Traffic (ADT/AADT)	
	Count*	Trend**
2003	42000	39800
2004	42500	39600
2005	39000	39400
2006	38000	39300
2007	39000	39100
2008	35000	38900
2009	34500	38700
2010	37000	38600
2011	36500	38400
2012	45500	38200
2013	38500	38000
2014	42500	37900
2015	34000	37700
2016	34500	37500
2017	40000	37300
2018	37000	37200
<b>2022 Opening Year Trend</b>		
2022	N/A	36500
<b>2027 Mid-Year Trend</b>		
2027	N/A	35600
<b>2032 Design Year Trend</b>		
2032	N/A	34700
<b>TRANPLAN Forecasts/Trends</b>		

** Annual Trend Increase:	-174
Trend R-squared:	6.10%
Trend Annual Historic Growth Rate:	-0.44%
Trend Growth Rate (2018 to Design Year):	-0.48%
Printed:	27-Jan-20
<b>Straight Line Growth Option</b>	

\*Axle-Adjusted

# APPENDIX H

---

## Committed Development Trip Generation





## *Traffic Impact Analysis*

# **The Henry 4015 Laguna Street Coral Gables, Florida**



**Kimley»»Horn**

© 2016 Kimley-Horn and Associates, Inc.  
April 2016  
043706000

(13.5%). The applied internal capture percentage is presented in Table 1 and detailed calculations are contained in Appendix C.

**Pass-By Capture Volumes**

A portion of the driveway volumes at the project site will be the result of new trips on the roadway network. The remainder of the driveway volumes will be trips from the adjacent traffic passing by the site (pass-by capture trips). Pass-by trips are intermediate stops on the way from an origin to a primary trip destination. Pass-by capture rates were estimated using ITE Land Use 820 (Shopping Center). The pass-by percentages were determined based on information provided in the ITE *Trip Generation Handbook*, 3<sup>rd</sup> Edition. The average pass-by capture used for the uses was 0.0 percent (0.0%) in the A.M. peak hour and 11.3 percent (11.3%) in the P.M. peak hour. The pass-by capture rates expected for the redevelopment are indicated in Table 1. Detailed calculations and figures depicting pass-by project trips are contained in Appendix C.

**Net New Project Trips**

Net new project trips are equal to the gross project trips minus the internal capture and pass-by capture trips. The net new project trips represent additional vehicles on the roadway network. As shown in Table 1, this project is expected to generate 64 net new trips during the A.M. peak hour and 102 net new trips during the P.M. peak hour.

Table 1: Peak Hour Trip Generation												
Land Uses	ITE Code	Scale	Gross Project Trips			Internal Capture		Pass-by Capture		Net New Project Trips		
			Enter	Exit	Total	%	Trips	%	Trips	Enter	Exit	Total
<i>Weekday A.M. Peak Hour [Weekday P.M. Peak Hour]</i>												
Apartment	220	123 d.u.	13 [55]	51 [30]	64 [85]	0.0% [10.6%]	0 [9]	0.0% [0.0%]	0 [0]	13 [48]	51 [28]	64 [76]
Specialty Retail Center	826	11 k.s.f.	0 [21]	0 [27]	0 [48]	0.0% [18.8%]	0 [9]	0.0% [34.0%]	0 [13]	0 [13]	0 [13]	0 [26]
<b>Total</b>			<b>13</b> [76]	<b>51</b> [57]	<b>64</b> [133]	<b>0.0%</b> [13.5%]	<b>0</b> [18]	<b>0.0%</b> [11.3%]	<b>0</b> [13]	<b>13</b> [61]	<b>51</b> [41]	<b>64</b> [102]

**Overall Trip Distribution**

# Merrick Manor

traffic study

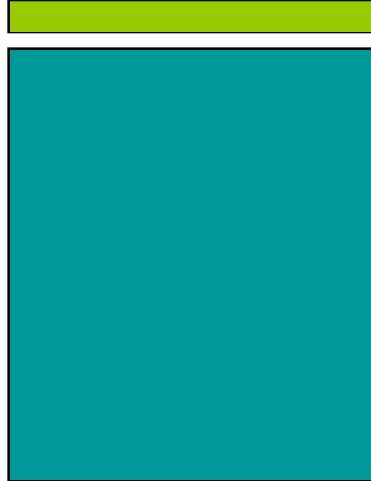

prepared for:  
**The Astor Companies**

**Traf Tech**  
ENGINEERING, INC.

**October 2011**

## TRIP GENERATION

---

The trip generation for the proposed Merrick Manor mixed-use development was based on information contained in the Institute of Transportation Engineer’s (ITE) *Trip Generation* manual (8<sup>th</sup> Edition). According to the subject ITE manual, the most appropriate “land use” categories for the subject project is ITE’s Land Use 220 – Apartment, ITE’s Land Use 814 – Specialty Retail, and ITE’s Land Use 931 – Quality Restaurant.

Table 1 summarizes the trip generation associated with the Merrick Manor development. As indicated in Table 1, the proposed mixed-use development is projected to generate approximately 1,851 new daily trips, approximately 101 new AM peak hour trips (22 inbound and 79 outbound), and approximately 168 new trip during the typical afternoon peak hour (109 inbound and 59 outbound).

<b>TABLE 1</b>						
<b>Merrick Manor</b>						
<b>Trip Generation Summary</b>						
Land Use	Size	Daily Trips	AM Peak Trips		PM Peak Trips	
			Inbound	Outbound	Inbound	Outbound
Apartments	188 units	1,263	19	77	79	42
Retail	1,900 sq.ft.	84	0	0	2	3
Restaurant	5,600 sq.ft.	504	3	2	28	14
Total External Trips		1,851	22	79	109	59

*Source: ITE Trip Generation Manual (8<sup>th</sup> Edition).*

The trip generation equations for the Merrick Manor mixed-use project, given by ITE, are:

**RESIDENTIAL LAND USE (Land Use 220)**

*Daily Trips*

$$T = 6.06 (X) + 123.56$$

Where T = average daily vehicle trip ends

X = number of residential units

*AM Peak Hour of Adjacent Street (Typical Morning Rush Hour)*

$$T = 0.49 (X) + 3.73 \text{ (20\% inbound and 80\% outbound)}$$

Where T = average AM peak hour vehicle trip ends

X = number of residential units

*PM Peak Hour of Adjacent Street (Typical Afternoon Rush Hour)*

$$T = 0.55 (X) + 17.65 \text{ (65\% inbound and 35\% outbound)}$$

Where T = average PM peak hour vehicle trip ends

X = number of residential units



**GABLES LIVING**  
*Traffic Study*



David Plummer & Associates

**Exhibit 10  
Project Trip Generation Summary**

Proposed ITE Land Use Designation <sup>1</sup>	Size/Units	AM Peak Hour Vehicle Trips			PM Peak Hour Vehicle Trips		
		In	Out	Total	In	Out	Total
Multifamily housing (mid-rise) (Land Use 221)	120 DU	11	30	41	32	21	53
		$Ln(T) = 0.98Ln(X) - 0.98$			$Ln(T) = 0.96Ln(X) - 0.63$		
		26% In		74% Out	61% In		39% Out
Shopping center (Land Use 820)	8,195 SF	14	11	25	47	46	93
		$Rate = \frac{3 \text{ trips}}{1000 \text{ SF GLA}}$			$Ln(T) = 0.72Ln(X) + 3.02$		
		54%		46%	50% In		50% Out
Subtotal Gross Trips		25	41	66	79	67	146
Internal Capture <sup>3</sup>	0% (AM) 23% (PM)	0	0	0	-17	-17	-34
Shopping Pass-by (PM)	34%	-	-	-	-13	-13	-26
Transit/ Pedestrian Trips	10%	-2	-4	-6	-5	-4	-9
<b>Net External Trips (Proposed)</b>		<b>23</b>	<b>37</b>	<b>60</b>	<b>44</b>	<b>33</b>	<b>77</b>

<sup>1</sup> Based on ITE Trip Generation Manual, Tenth Edition,

<sup>3</sup> Based on ITE Trip Generation Manual User's Guide and Handbook, Tenth Edition

# APPENDIX I

---

## Trip Generation and Internal Capture Rate

# Multifamily Housing (Mid-Rise) (221)

Vehicle Trip Ends vs: Dwelling Units  
 On a: Weekday,  
 Peak Hour of Adjacent Street Traffic,  
 One Hour Between 7 and 9 a.m.

Setting/Location: General Urban/Suburban

Number of Studies: 53  
 Avg. Num. of Dwelling Units: 207  
 Directional Distribution: 26% entering, 74% exiting

## Vehicle Trip Generation per Dwelling Unit

Average Rate	Range of Rates	Standard Deviation
0.36	0.06 - 1.61	0.19

## Data Plot and Equation

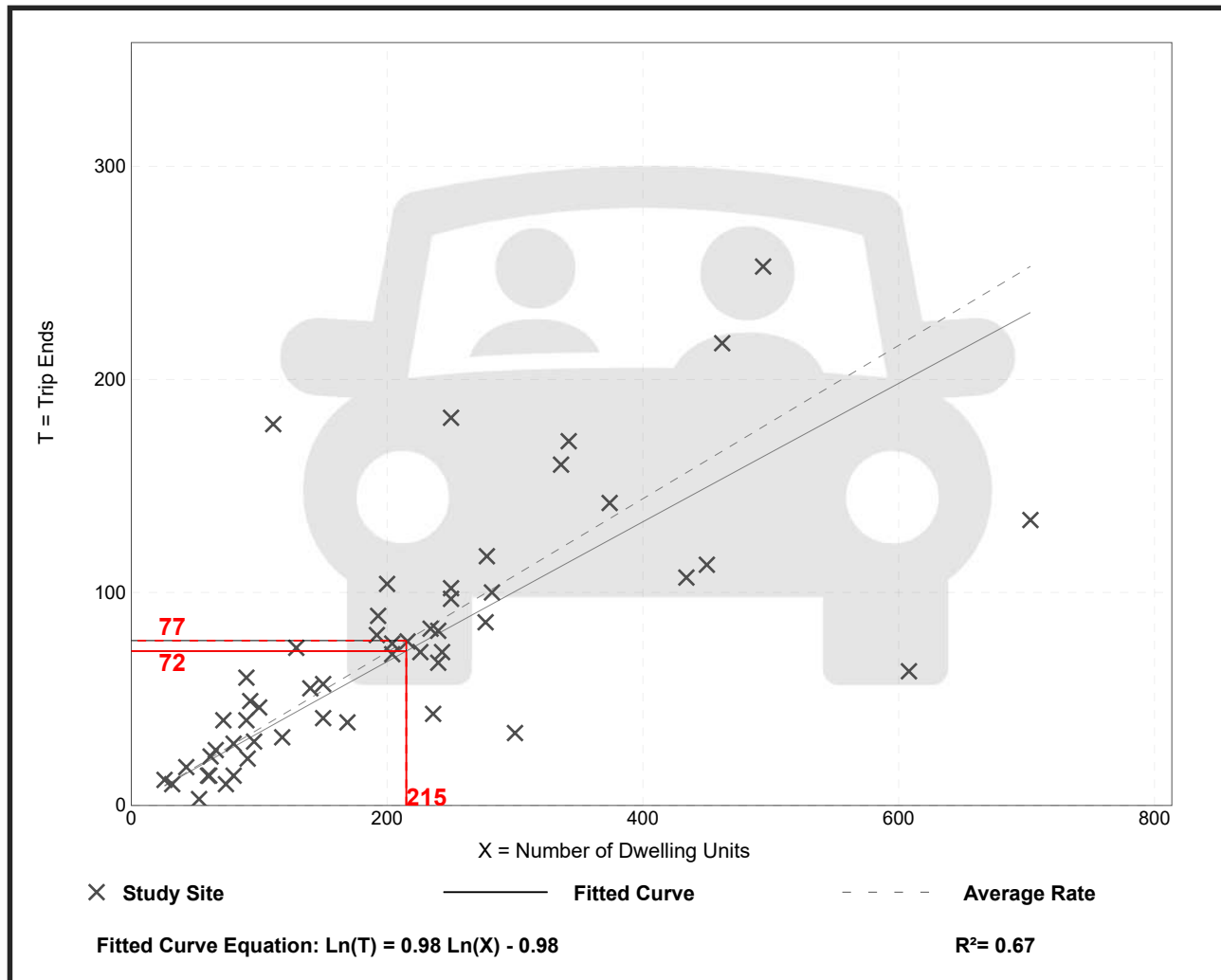



# Multifamily Housing (Mid-Rise) (221)

Vehicle Trip Ends vs: Dwelling Units  
 On a: Weekday,  
 Peak Hour of Adjacent Street Traffic,  
 One Hour Between 4 and 6 p.m.  
 Setting/Location: General Urban/Suburban  
 Number of Studies: 60  
 Avg. Num. of Dwelling Units: 208  
 Directional Distribution: 61% entering, 39% exiting

## Vehicle Trip Generation per Dwelling Unit

Average Rate	Range of Rates	Standard Deviation
0.44	0.15 - 1.11	0.19

## Data Plot and Equation

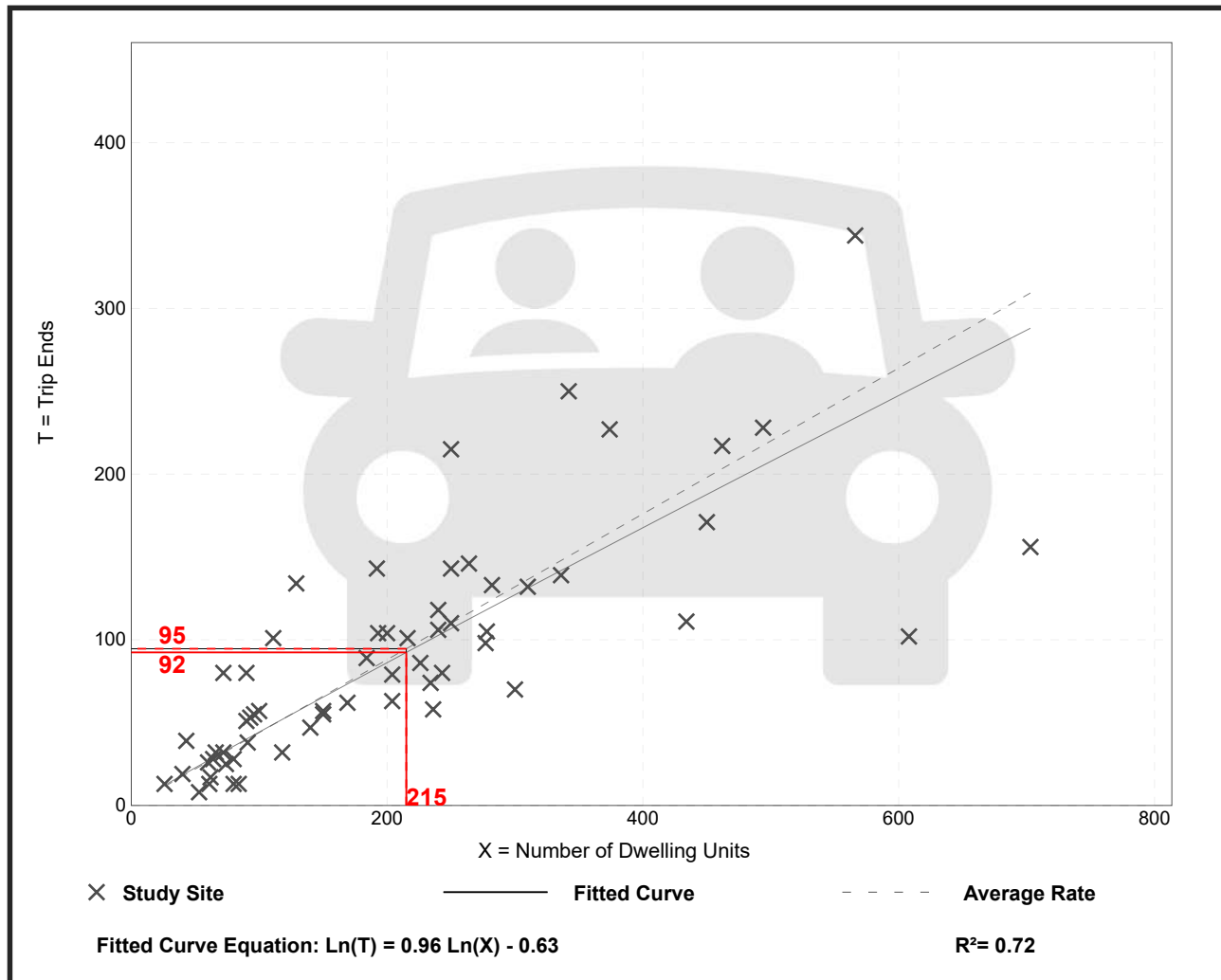

# General Office Building (710)

**Vehicle Trip Ends vs: 1000 Sq. Ft. GFA**  
**On a: Weekday,**  
**Peak Hour of Adjacent Street Traffic,**  
**One Hour Between 7 and 9 a.m.**  
**Setting/Location: General Urban/Suburban**  
 Number of Studies: 35  
 Avg. 1000 Sq. Ft. GFA: 117  
 Directional Distribution: 86% entering, 14% exiting

## Vehicle Trip Generation per 1000 Sq. Ft. GFA

Average Rate	Range of Rates	Standard Deviation
1.16	0.37 - 4.23	0.47

## Data Plot and Equation

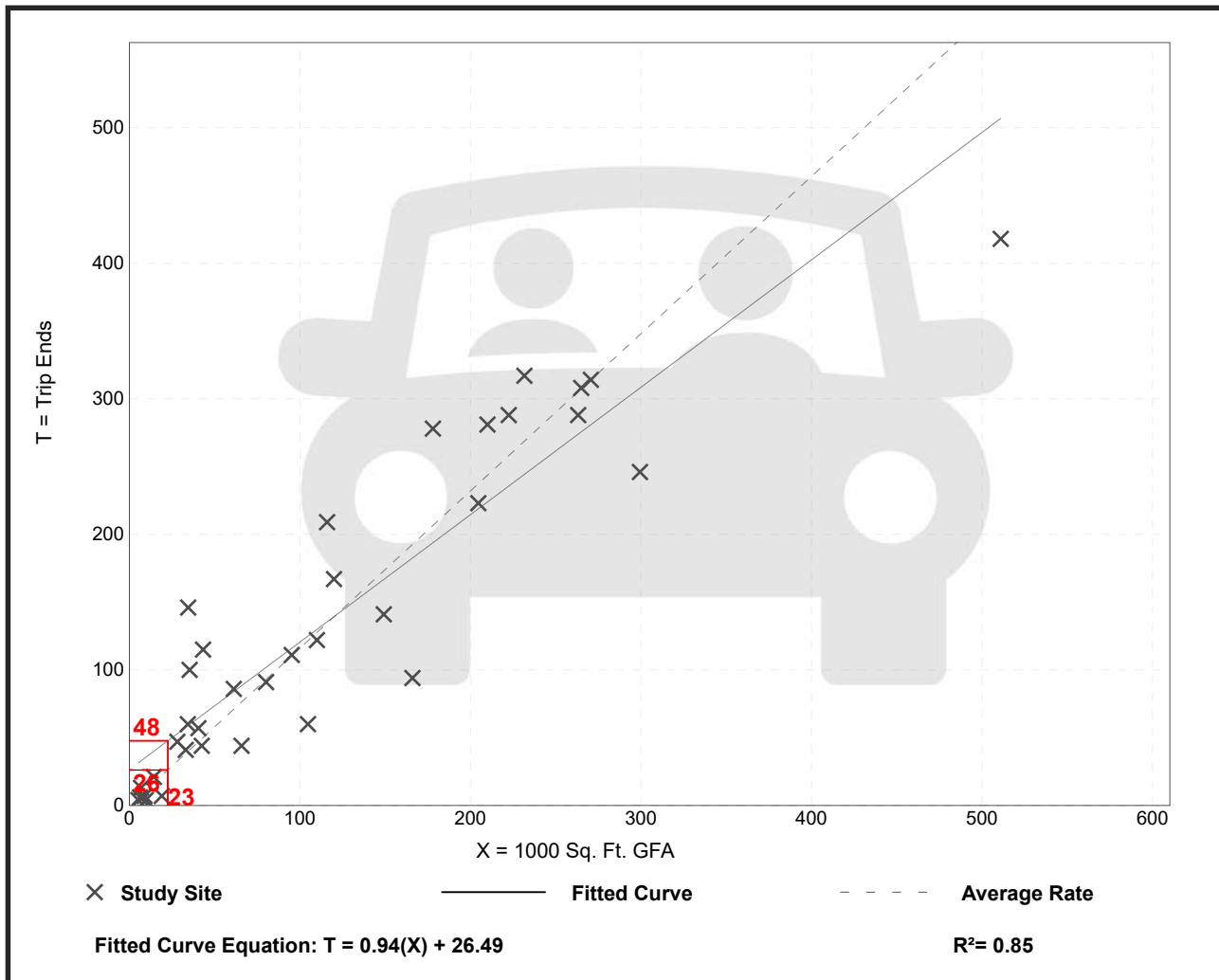

# General Office Building (710)

**Vehicle Trip Ends vs: 1000 Sq. Ft. GFA**  
**On a: Weekday,**  
**Peak Hour of Adjacent Street Traffic,**  
**One Hour Between 4 and 6 p.m.**  
**Setting/Location: General Urban/Suburban**  
 Number of Studies: 32  
 Avg. 1000 Sq. Ft. GFA: 114  
 Directional Distribution: 16% entering, 84% exiting

## Vehicle Trip Generation per 1000 Sq. Ft. GFA

Average Rate	Range of Rates	Standard Deviation
1.15	0.47 - 3.23	0.42

## Data Plot and Equation

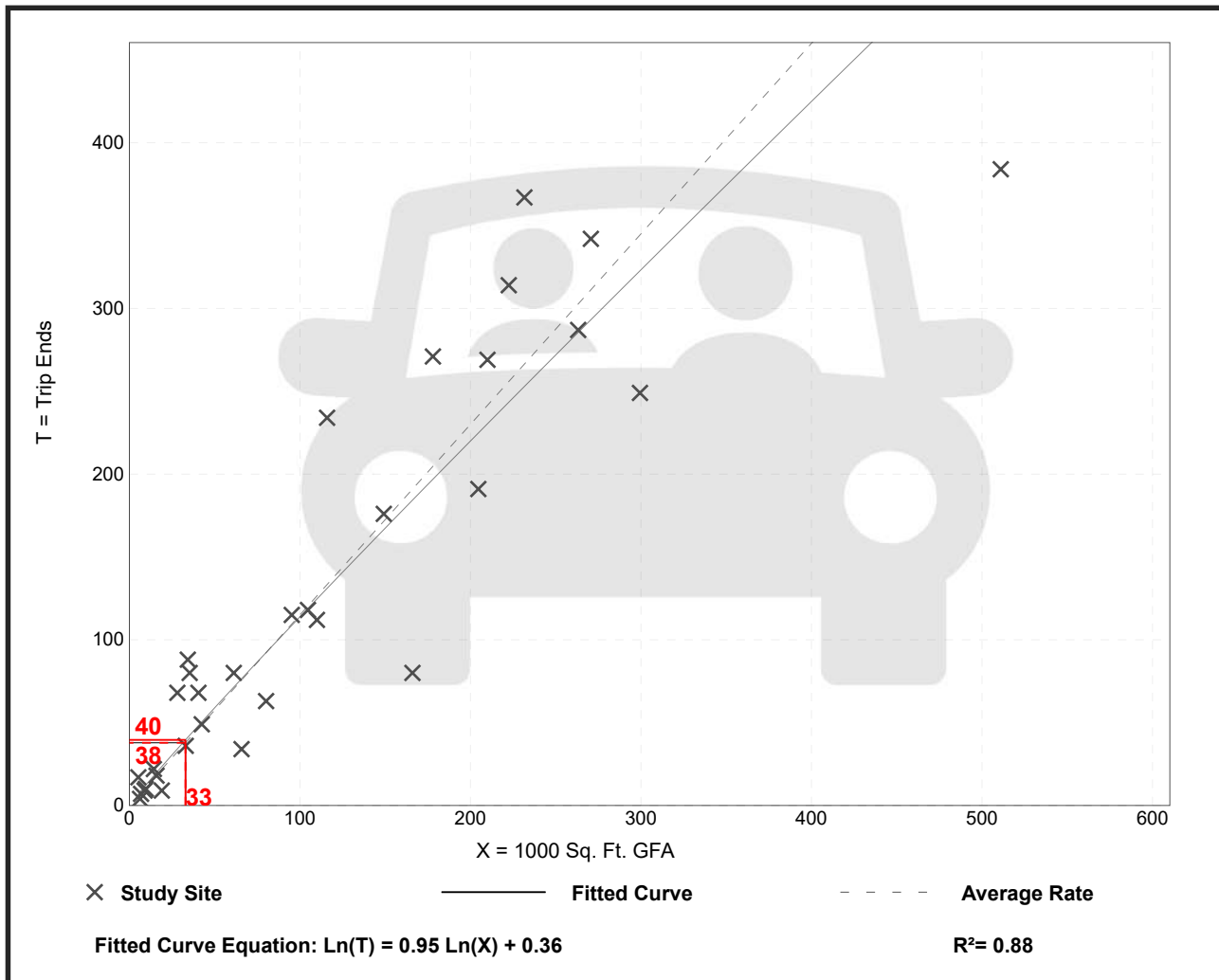

# Shopping Center (820)

**Vehicle Trip Ends vs: 1000 Sq. Ft. GLA**  
**On a: Weekday,**  
**Peak Hour of Adjacent Street Traffic,**  
**One Hour Between 7 and 9 a.m.**  
**Setting/Location: General Urban/Suburban**  
 Number of Studies: 84  
 Avg. 1000 Sq. Ft. GLA: 351  
 Directional Distribution: 62% entering, 38% exiting

## Vehicle Trip Generation per 1000 Sq. Ft. GLA

Average Rate	Range of Rates	Standard Deviation
0.94	0.18 - 23.74	0.87

## Data Plot and Equation

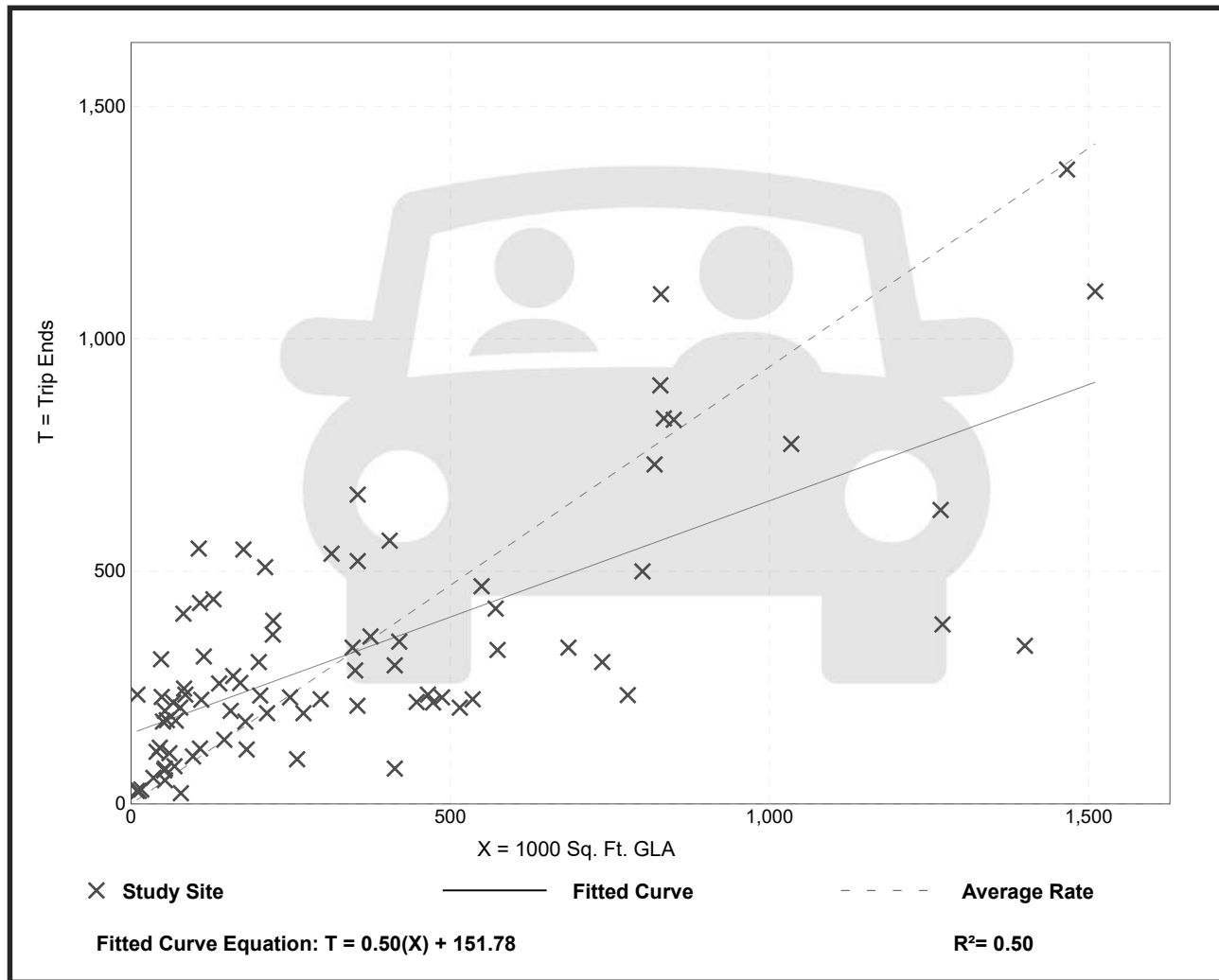

# Shopping Center (820)

**Vehicle Trip Ends vs: 1000 Sq. Ft. GLA**  
**On a: Weekday,**  
**Peak Hour of Adjacent Street Traffic,**  
**One Hour Between 4 and 6 p.m.**  
**Setting/Location: General Urban/Suburban**  
 Number of Studies: 261  
 Avg. 1000 Sq. Ft. GLA: 327  
 Directional Distribution: 48% entering, 52% exiting

## Vehicle Trip Generation per 1000 Sq. Ft. GLA

Average Rate	Range of Rates	Standard Deviation
3.81	0.74 - 18.69	2.04

## Data Plot and Equation

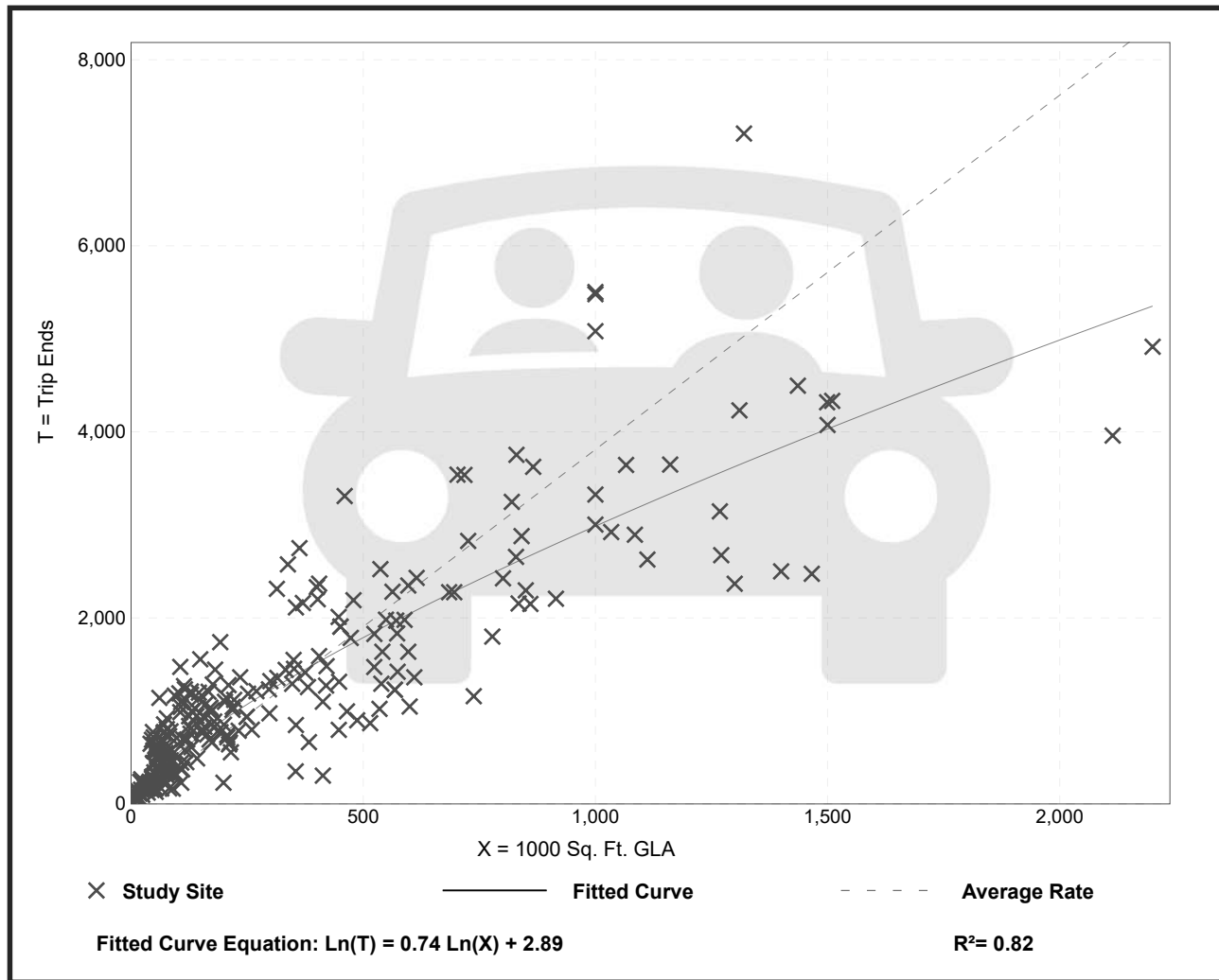

## AM Peak Hour Internalization

Apartments (LU 221) 215 units		Retail (LU 820) 10,902 sq. ft.		Office (LU 710) 29, 508 sq. ft.		Total ITE Trips
In	Out	In	Out	In	Out	
18	54	7	4	41	7	131
<b>Unbalanced Internalization</b>						
	1% 1		17% 1			
2% 1.0	1	1	1			
		1		14% 1		
	2% 1		1		3% 1	
0% 0		0				1% 1
		32% 2		2		28% 2
			29% 1	1	4% 2	
Apartments (LU 221) 215 units		Retail (LU 820) 10,902 sq. ft.		Office (LU 710) 29, 508 sq. ft.		Total ITE Trips
In	Out	In	Out	In	Out	
18	54	7	4	41	7	131
<b>Balanced Internalization</b>						
	-1	-1				
-1			-1			
	-1			-1		
0						0
		-2				-2
			-1	-1		
-1	-2	-3	-2	-2	-2	-11 Internal Trips
17	52	5	2	39	5	-8.2% Internalization
						<b>120 Net New External</b>

### PM Peak Hour Internalization

Apartments (LU 221) 215 units		Retail (LU 820) 10,902 sq. ft.		Office (LU 710) 29, 508 sq. ft.		Total ITE Trips
In	Out	In	Out	In	Out	
56	36	22	23	4	24	165
<b>Unbalanced Internalization</b>						
	42%		10%			
	15	<b>2</b>	2.2			
46%			26%			
25.76	<b>6</b>		6			
	4%			57%		
	1		<b>1</b>	2		
4%					2%	
2.24	<b>0</b>				0	
		8%			20%	
		2		<b>2</b>	5	
			2%	31%		
			1	<b>1</b>	1	
Apartments (LU 221) 215 units		Retail (LU 820) 10,902 sq. ft.		Office (LU 710) 29, 508 sq. ft.		Total ITE Trips
In	Out	In	Out	In	Out	
56	36	22	23	4	24	165
<b>Balanced Internalization</b>						
	-2	-2				
-6			-6			
	-1			-1		
0					0	
		-2			-2	
			-1	-1		
-6	-4	-4	-7	-2	-2	
<b>50</b>	<b>32</b>	<b>18</b>	<b>16</b>	<b>2</b>	<b>22</b>	-26 Internal Trips -15.6% Internalization <b>139 Net New External</b>

## APPENDIX J

---

### Cardinal Traffic Analysis Zone Trip Distribution





## Miami-Dade 2040 Directional Distribution Summary

Origin TAZ			Cardinal Directions								Total
County TAZ	Regional TAZ		NNE	ENE	ESE	SSE	SSW	WSW	WNW	NNW	
1087	3987	PERCENT	22.6	12.5	1.1	5.9	6.9	18.8	12.2	20.1	
1088	3988	TRIPS	1,842	386	35	0	309	1,087	1,272	1,611	6,542
1088	3988	PERCENT	28.2	5.9	0.5	0.0	4.7	16.6	19.4	24.6	
1089	3989	TRIPS	352	75	8	0	66	237	195	317	1,250
1089	3989	PERCENT	28.2	6.0	0.6	0.0	5.3	19.0	15.6	25.4	
1090	3990	TRIPS	629	59	1	8	48	290	191	401	1,627
1090	3990	PERCENT	38.7	3.6	0.1	0.5	3.0	17.8	11.7	24.7	
1091	3991	TRIPS	871	86	1	0	164	721	565	978	3,386
1091	3991	PERCENT	25.7	2.5	0.0	0.0	4.8	21.3	16.7	28.9	
1092	3992	TRIPS	1,104	458	13	20	210	716	389	670	3,580
1092	3992	PERCENT	30.8	12.8	0.4	0.6	5.9	20.0	10.9	18.7	
1093	3993	TRIPS	358	102	4	0	94	198	180	277	1,213
1093	3993	PERCENT	29.5	8.4	0.3	0.0	7.8	16.3	14.8	22.8	
1094	3994	TRIPS	1,504	422	34	0	309	1,103	595	1,217	5,184
1094	3994	PERCENT	29.0	8.1	0.7	0.0	6.0	21.3	11.5	23.5	
1095	3995	TRIPS	1,216	859	92	104	265	899	844	1,136	5,415
1095	3995	PERCENT	22.5	15.9	1.7	1.9	4.9	16.6	15.6	21.0	
1096	3996	TRIPS	1,294	899	61	108	487	968	485	1,188	5,490
1096	3996	PERCENT	23.6	16.4	1.1	2.0	8.9	17.6	8.8	21.6	
1097	3997	TRIPS	1,007	604	195	121	535	875	680	1,104	5,121
1097	3997	PERCENT	19.7	11.8	3.8	2.4	10.5	17.1	13.3	21.6	
1098	3998	TRIPS	4,106	2,721	770	325	1,967	3,116	1,814	2,952	17,771
1098	3998	PERCENT	23.1	15.3	4.3	1.8	11.1	17.5	10.2	16.6	
1099	3999	TRIPS	1,774	1,222	134	241	1,032	1,110	776	1,144	7,433
1099	3999	PERCENT	23.9	16.4	1.8	3.2	13.9	14.9	10.4	15.4	
1100	4000	TRIPS	1,206	588	25	21	353	697	922	1,014	4,826
1100	4000	PERCENT	25.0	12.2	0.5	0.4	7.3	14.4	19.1	21.0	
1101	4001	TRIPS	153	28	4	0	24	102	107	167	585
1101	4001	PERCENT	26.2	4.8	0.7	0.0	4.1	17.4	18.3	28.6	
1102	4002	TRIPS	296	43	7	12	57	230	96	202	943
1102	4002	PERCENT	31.4	4.6	0.7	1.3	6.0	24.4	10.2	21.4	
1103	4003	TRIPS	3,538	1,620	202	221	1,811	3,637	1,484	2,051	14,564
1103	4003	PERCENT	24.3	11.1	1.4	1.5	12.4	25.0	10.2	14.1	
1104	4004	TRIPS	852	175	26	27	235	487	256	545	2,603
1104	4004	PERCENT	32.7	6.7	1.0	1.0	9.0	18.7	9.8	20.9	
1105	4005	TRIPS	2,043	848	70	130	545	1,447	874	1,191	7,148
1105	4005	PERCENT	28.6	11.9	1.0	1.8	7.6	20.2	12.2	16.7	
1106	4006	TRIPS	953	676	83	110	666	964	467	773	4,692
1106	4006	PERCENT	20.3	14.4	1.8	2.3	14.2	20.6	10.0	16.5	
1107	4007	TRIPS	1,923	1,441	188	499	1,806	1,875	1,306	1,387	10,425
1107	4007	PERCENT	18.5	13.8	1.8	4.8	17.3	18.0	12.5	13.3	

# APPENDIX K

---

## Synchro Level-of-Service (LOS) Analysis Output Reports























## AM Peak Hour Existing Conditions

---

## Intersection LOS



























---

HCM 6th Signalized Intersection Summary  
 2594: Ponce de Leon Blvd & Bird Road



















												
Movement	EBL	EBT	EBR	WBL	WBT	WBR	NBL	NBT	NBR	SBL	SBT	SBR
Lane Configurations												
Traffic Volume (veh/h)	161	1171	111	156	1048	176	49	339	45	159	389	57
Future Volume (veh/h)	161	1171	111	156	1048	176	49	339	45	159	389	57
Initial Q (Qb), veh	0	0	0	0	0	0	0	0	0	0	0	0
Ped-Bike Adj(A_pbT)	1.00		1.00	1.00		1.00	1.00		1.00	1.00		1.00
Parking Bus, Adj	1.00	1.00	1.00	1.00	1.00	1.00	1.00	1.00	1.00	1.00	1.00	1.00
Work Zone On Approach		No			No			No			No	
Adj Sat Flow, veh/h/ln	1670	1670	1670	1683	1683	1683	1670	1670	1670	1683	1683	1683
Adj Flow Rate, veh/h	169	1233	117	164	1103	185	52	357	47	167	409	60
Peak Hour Factor	0.95	0.95	0.95	0.95	0.95	0.95	0.95	0.95	0.95	0.95	0.95	0.95
Percent Heavy Veh, %	3	3	3	2	2	2	3	3	3	2	2	2
Cap, veh/h	243	1858	880	242	1599	267	145	398	52	171	570	333
Arrive On Green	0.06	0.59	0.59	0.05	0.58	0.58	0.04	0.14	0.14	0.07	0.18	0.18
Sat Flow, veh/h	1590	3173	1415	1603	2742	458	1590	2822	369	1603	3198	1427
Grp Volume(v), veh/h	169	1233	117	164	642	646	52	200	204	167	409	60
Grp Sat Flow(s),veh/h/ln	1590	1586	1415	1603	1599	1601	1590	1586	1604	1603	1599	1427
Q Serve(g_s), s	7.7	47.4	6.1	7.5	50.3	50.7	5.0	22.2	22.6	13.2	21.7	6.1
Cycle Q Clear(g_c), s	7.7	47.4	6.1	7.5	50.3	50.7	5.0	22.2	22.6	13.2	21.7	6.1
Prop In Lane	1.00		1.00	1.00		0.29	1.00		0.23	1.00		1.00
Lane Grp Cap(c), veh/h	243	1858	880	242	933	934	145	224	226	171	570	333
V/C Ratio(X)	0.70	0.66	0.13	0.68	0.69	0.69	0.36	0.89	0.90	0.97	0.72	0.18
Avail Cap(c_a), veh/h	329	1858	880	270	933	934	204	325	329	171	656	371
HCM Platoon Ratio	1.00	1.00	1.00	1.00	1.00	1.00	1.00	1.00	1.00	1.00	1.00	1.00
Upstream Filter(I)	1.00	1.00	1.00	1.00	1.00	1.00	1.00	1.00	1.00	1.00	1.00	1.00
Uniform Delay (d), s/veh	26.0	25.3	14.0	24.5	26.1	26.2	63.7	75.9	76.1	66.0	69.7	55.2
Incr Delay (d2), s/veh	1.7	1.9	0.3	4.2	4.1	4.2	0.6	17.2	19.0	60.9	2.9	0.2
Initial Q Delay(d3),s/veh	0.0	0.0	0.0	0.0	0.0	0.0	0.0	0.0	0.0	0.0	0.0	0.0
%ile BackOfQ(50%),veh/ln	3.4	18.3	0.1	3.3	20.1	20.3	2.1	10.2	10.6	4.9	9.2	2.2
Unsig. Movement Delay, s/veh												
LnGrp Delay(d),s/veh	27.7	27.2	14.4	28.7	30.2	30.4	64.2	93.1	95.1	126.9	72.6	55.4
LnGrp LOS	C	C	B	C	C	C	E	F	F	F	E	E
Approach Vol, veh/h		1519			1452			456			636	
Approach Delay, s/veh		26.3			30.1			90.7			85.2	
Approach LOS		C			C			F			F	
Timer - Assigned Phs	1	2	3	4	5	6	7	8				
Phs Duration (G+Y+Rc), s	15.8	111.7	13.3	39.2	16.2	111.3	20.0	32.5				
Change Period (Y+Rc), s	* 6.3	* 6.3	* 6.8	7.1	* 6.3	* 6.3	* 6.8	7.1				
Max Green Setting (Gmax), s	* 13	* 91	* 13	36.9	* 20	* 84	* 13	36.9				
Max Q Clear Time (g_c+I1), s	9.5	0.0	7.0	23.7	9.7	0.0	15.2	24.6				
Green Ext Time (p_c), s	0.1	0.0	0.0	1.2	0.2	0.0	0.0	0.8				
<b>Intersection Summary</b>												
HCM 6th Ctrl Delay			44.1									
HCM 6th LOS			D									
<b>Notes</b>												
* HCM 6th computational engine requires equal clearance times for the phases crossing the barrier.												

# HCM 6th Signalized Intersection Summary

## 2595: LeJeune Rd & Bird Road

												
Movement	EBL	EBT	EBR	WBL	WBT	WBR	NBL	NBT	NBR	SBL	SBT	SBR
Lane Configurations		 			  			 			 	
Traffic Volume (veh/h)	174	1310	161	80	924	149	105	723	38	136	693	51
Future Volume (veh/h)	174	1310	161	80	924	149	105	723	38	136	693	51
Initial Q (Qb), veh	0	0	0	0	0	0	0	0	0	0	0	0
Ped-Bike Adj(A_pbT)	1.00		1.00	1.00		1.00	1.00		1.00	1.00		1.00
Parking Bus, Adj	1.00	1.00	1.00	1.00	1.00	1.00	1.00	1.00	1.00	1.00	1.00	1.00
Work Zone On Approach		No			No			No			No	
Adj Sat Flow, veh/h/ln	1856	1856	1856	1856	1856	1856	1870	1870	1870	1856	1856	1856
Adj Flow Rate, veh/h	176	1323	163	81	933	151	106	730	38	137	700	52
Peak Hour Factor	0.99	0.99	0.99	0.99	0.99	0.99	0.99	0.99	0.99	0.99	0.99	0.99
Percent Heavy Veh, %	3	3	3	3	3	3	2	2	2	3	3	3
Cap, veh/h	342	1916	855	190	2269	366	157	781	41	156	767	57
Arrive On Green	0.06	0.54	0.54	0.03	0.52	0.52	0.06	0.23	0.23	0.06	0.23	0.23
Sat Flow, veh/h	1767	3526	1572	1767	4396	709	1781	3436	179	1767	3327	247
Grp Volume(v), veh/h	176	1323	163	81	716	368	106	377	391	137	371	381
Grp Sat Flow(s),veh/h/ln	1767	1763	1572	1767	1689	1728	1781	1777	1838	1767	1763	1811
Q Serve(g_s), s	8.7	51.3	9.9	4.1	24.3	24.5	8.5	39.0	39.0	11.1	38.3	38.4
Cycle Q Clear(g_c), s	8.7	51.3	9.9	4.1	24.3	24.5	8.5	39.0	39.0	11.1	38.3	38.4
Prop In Lane	1.00		1.00	1.00		0.41	1.00		0.10	1.00		0.14
Lane Grp Cap(c), veh/h	342	1916	855	190	1743	892	157	404	418	156	406	417
V/C Ratio(X)	0.51	0.69	0.19	0.43	0.41	0.41	0.68	0.93	0.93	0.88	0.91	0.91
Avail Cap(c_a), veh/h	426	1916	855	199	1743	892	228	467	483	156	463	476
HCM Platoon Ratio	1.00	1.00	1.00	1.00	1.00	1.00	1.00	1.00	1.00	1.00	1.00	1.00
Upstream Filter(l)	1.00	1.00	1.00	1.00	1.00	1.00	0.96	0.96	0.96	1.00	1.00	1.00
Uniform Delay (d), s/veh	20.9	31.2	21.7	27.4	27.8	27.8	55.5	70.9	70.9	56.5	70.1	70.1
Incr Delay (d2), s/veh	1.4	2.1	0.5	0.6	0.7	1.4	1.8	23.4	23.0	37.4	20.5	20.3
Initial Q Delay(d3),s/veh	0.0	0.0	0.0	0.0	0.0	0.0	0.0	0.0	0.0	0.0	0.0	0.0
%ile BackOfQ(50%),veh/ln	3.8	22.4	3.8	1.8	10.2	10.6	3.9	20.2	20.9	6.6	19.5	20.0
Unsig. Movement Delay, s/veh												
LnGrp Delay(d),s/veh	22.3	33.3	22.2	28.0	28.5	29.2	57.3	94.2	93.8	94.0	90.6	90.4
LnGrp LOS	C	C	C	C	C	C	E	F	F	F	F	F
Approach Vol, veh/h		1662			1165			874			889	
Approach Delay, s/veh		31.0			28.7			89.6			91.0	
Approach LOS		C			C			F			F	
Timer - Assigned Phs	1	2	3	4	5	6	7	8				
Phs Duration (G+Y+Rc), s	12.0	107.6	17.4	50.0	17.1	102.5	18.0	49.4				
Change Period (Y+Rc), s	6.0	6.0	6.9	6.9	6.0	6.0	6.9	6.9				
Max Green Setting (Gmax), s	7.0	87.0	18.0	49.1	20.0	74.0	11.1	49.1				
Max Q Clear Time (g_c+I1), s	6.1	0.0	10.5	40.4	10.7	0.0	13.1	41.0				
Green Ext Time (p_c), s	0.0	0.0	0.1	1.5	0.4	0.0	0.0	1.5				
<b>Intersection Summary</b>												
HCM 6th Ctrl Delay			53.2									
HCM 6th LOS			D									

HCM 6th Signalized Intersection Summary  
 3272: LeJeune Rd & Altara Ave

												
Movement	EBL	EBT	EBR	WBL	WBT	WBR	NBL	NBT	NBR	SBL	SBT	SBR
Lane Configurations												
Traffic Volume (veh/h)	0	0	0	45	0	43	0	844	53	51	893	0
Future Volume (veh/h)	0	0	0	45	0	43	0	844	53	51	893	0
Initial Q (Qb), veh	0	0	0	0	0	0	0	0	0	0	0	0
Ped-Bike Adj(A_pbT)	1.00		1.00	1.00		1.00	1.00		1.00	1.00		1.00
Parking Bus, Adj	1.00	1.00	1.00	1.00	1.00	1.00	1.00	1.00	1.00	1.00	1.00	1.00
Work Zone On Approach		No			No			No			No	
Adj Sat Flow, veh/h/ln	1900	1900	1900	1870	1870	1870	1870	1870	1870	1870	1870	1870
Adj Flow Rate, veh/h	0	0	0	48	0	46	0	908	57	55	960	0
Peak Hour Factor	0.93	0.93	0.93	0.93	0.93	0.93	0.93	0.93	0.93	0.93	0.93	0.93
Percent Heavy Veh, %	0	0	0	2	2	2	2	2	2	2	2	0
Cap, veh/h	0	140	0	82	5	54	40	2914	183	509	3050	0
Arrive On Green	0.00	0.00	0.00	0.07	0.00	0.07	0.00	0.86	0.86	0.86	0.86	0.00
Sat Flow, veh/h	0	1900	0	707	65	740	585	3396	213	582	3647	0
Grp Volume(v), veh/h	0	0	0	94	0	0	0	475	490	55	960	0
Grp Sat Flow(s),veh/h/ln	0	1900	0	1511	0	0	585	1777	1832	582	1777	0
Q Serve(g_s), s	0.0	0.0	0.0	10.1	0.0	0.0	0.0	9.3	9.3	3.6	9.5	0.0
Cycle Q Clear(g_c), s	0.0	0.0	0.0	11.0	0.0	0.0	0.0	9.3	9.3	13.0	9.5	0.0
Prop In Lane	0.00		0.00	0.51		0.49	1.00		0.12	1.00		0.00
Lane Grp Cap(c), veh/h	0	140	0	141	0	0	40	1525	1572	509	3050	0
V/C Ratio(X)	0.00	0.00	0.00	0.67	0.00	0.00	0.00	0.31	0.31	0.11	0.31	0.00
Avail Cap(c_a), veh/h	0	875	0	720	0	0	40	1525	1572	509	3050	0
HCM Platoon Ratio	1.00	1.00	1.00	1.00	1.00	1.00	1.00	1.00	1.00	1.00	1.00	1.00
Upstream Filter(l)	0.00	0.00	0.00	1.00	0.00	0.00	0.00	1.00	1.00	0.59	0.59	0.00
Uniform Delay (d), s/veh	0.0	0.0	0.0	82.3	0.0	0.0	0.0	2.5	2.5	3.7	2.5	0.0
Incr Delay (d2), s/veh	0.0	0.0	0.0	5.3	0.0	0.0	0.0	0.5	0.5	0.3	0.2	0.0
Initial Q Delay(d3),s/veh	0.0	0.0	0.0	0.0	0.0	0.0	0.0	0.0	0.0	0.0	0.0	0.0
%ile BackOfQ(50%),veh/ln	0.0	0.0	0.0	4.6	0.0	0.0	0.0	2.8	2.9	0.4	2.7	0.0
Unsig. Movement Delay, s/veh												
LnGrp Delay(d),s/veh	0.0	0.0	0.0	87.6	0.0	0.0	0.0	3.0	3.0	4.0	2.6	0.0
LnGrp LOS	A	A	A	F	A	A	A	A	A	A	A	A
Approach Vol, veh/h		0			94			965			1015	
Approach Delay, s/veh		0.0			87.6			3.0			2.7	
Approach LOS					F			A			A	
Timer - Assigned Phs		2		4		6		8				
Phs Duration (G+Y+Rc), s		160.5		19.5		160.5		19.5				
Change Period (Y+Rc), s		6.0		* 6.3		6.0		* 6.3				
Max Green Setting (Gmax), s		84.8		* 83		84.8		* 83				
Max Q Clear Time (g_c+I1), s		0.0		0.0		0.0		13.0				
Green Ext Time (p_c), s		0.0		0.0		0.0		0.3				
<b>Intersection Summary</b>												
HCM 6th Ctrl Delay				6.7								
HCM 6th LOS				A								
<b>Notes</b>												
* HCM 6th computational engine requires equal clearance times for the phases crossing the barrier.												

# HCM 6th Signalized Intersection Summary

## 6165: Ponce de Leon Blvd & San Lorenzo Ave



Movement	EBL	EBR	NBL	NBT	SBT	SBR
Lane Configurations						
Traffic Volume (veh/h)	8	23	40	459	519	22
Future Volume (veh/h)	8	23	40	459	519	22
Initial Q (Qb), veh	0	0	0	0	0	0
Ped-Bike Adj(A_pbT)	1.00	1.00	1.00			1.00
Parking Bus, Adj	1.00	1.00	1.00	1.00	1.00	1.00
Work Zone On Approach	No			No	No	
Adj Sat Flow, veh/h/ln	1900	1900	1856	1856	1870	1870
Adj Flow Rate, veh/h	9	25	43	494	558	24
Peak Hour Factor	0.93	0.93	0.93	0.93	0.93	0.93
Percent Heavy Veh, %	0	0	3	3	2	2
Cap, veh/h	19	54	663	2790	2340	101
Arrive On Green	0.05	0.05	0.04	0.79	0.67	0.67
Sat Flow, veh/h	408	1133	1767	3618	3565	149
Grp Volume(v), veh/h	35	0	43	494	285	297
Grp Sat Flow(s),veh/h/ln	1587	0	1767	1763	1777	1844
Q Serve(g_s), s	1.7	0.0	0.5	2.7	5.0	5.0
Cycle Q Clear(g_c), s	1.7	0.0	0.5	2.7	5.0	5.0
Prop In Lane	0.26	0.71	1.00			0.08
Lane Grp Cap(c), veh/h	75	0	663	2790	1198	1243
V/C Ratio(X)	0.47	0.00	0.06	0.18	0.24	0.24
Avail Cap(c_a), veh/h	514	0	880	2790	1198	1243
HCM Platoon Ratio	1.00	1.00	1.00	1.00	1.00	1.00
Upstream Filter(l)	1.00	0.00	1.00	1.00	1.00	1.00
Uniform Delay (d), s/veh	37.1	0.0	3.1	2.0	5.1	5.1
Incr Delay (d2), s/veh	3.3	0.0	0.0	0.1	0.5	0.5
Initial Q Delay(d3),s/veh	0.0	0.0	0.0	0.0	0.0	0.0
%ile BackOfQ(50%),veh/ln	0.7	0.0	0.1	0.6	1.6	1.7
Unsig. Movement Delay, s/veh						
LnGrp Delay(d),s/veh	40.4	0.0	3.2	2.2	5.5	5.5
LnGrp LOS	D	A	A	A	A	A
Approach Vol, veh/h	35			537	582	
Approach Delay, s/veh	40.4			2.2	5.5	
Approach LOS	D			A	A	
Timer - Assigned Phs		2		4	5	6
Phs Duration (G+Y+Rc), s		69.9		10.1	9.4	60.5
Change Period (Y+Rc), s		6.6		* 6.3	* 6.3	6.6
Max Green Setting (Gmax), s		41.2		* 26	* 13	22.0
Max Q Clear Time (g_c+I1), s		0.0		3.7	2.5	0.0
Green Ext Time (p_c), s		0.0		0.1	0.0	0.0
<b>Intersection Summary</b>						
HCM 6th Ctrl Delay			5.1			
HCM 6th LOS			A			
<b>Notes</b>						
* HCM 6th computational engine requires equal clearance times for the phases crossing the barrier.						



HCM 6th TWSC  
 1: Salzedo St & Bird Road

Intersection						
Int Delay, s/veh	0.5					
Movement	EBT	EBR	WBL	WBT	NBL	NBR
Lane Configurations	↑↑	↑		↑↑↑	↑	
Traffic Vol, veh/h	1485	20	0	1198	12	21
Future Vol, veh/h	1485	20	0	1198	12	21
Conflicting Peds, #/hr	0	5	0	0	0	0
Sign Control	Free	Free	Free	Free	Stop	Stop
RT Channelized	-	None	-	None	-	None
Storage Length	-	208	-	-	0	-
Veh in Median Storage, #	0	-	-	0	0	-
Grade, %	0	-	-	0	0	-
Peak Hour Factor	97	97	97	97	97	97
Heavy Vehicles, %	2	2	0	3	0	0
Mvmt Flow	1531	21	0	1235	12	22

Major/Minor	Major1	Major2	Minor1		
Conflicting Flow All	0	0	-	-	2030 771
Stage 1	-	-	-	-	1536 -
Stage 2	-	-	-	-	494 -
Critical Hdwy	-	-	-	-	6.25 6.9
Critical Hdwy Stg 1	-	-	-	-	5.8 -
Critical Hdwy Stg 2	-	-	-	-	6 -
Follow-up Hdwy	-	-	-	-	3.65 3.3
Pot Cap-1 Maneuver	-	-	0	-	69 347
Stage 1	-	-	0	-	164 -
Stage 2	-	-	0	-	550 -
Platoon blocked, %	-	-	-	-	
Mov Cap-1 Maneuver	-	-	-	-	69 345
Mov Cap-2 Maneuver	-	-	-	-	69 -
Stage 1	-	-	-	-	163 -
Stage 2	-	-	-	-	550 -

Approach	EB	WB	NB
HCM Control Delay, s	0	0	38.5
HCM LOS			E

Minor Lane/Major Mvmt	NBLn1	EBT	EBR	WBT
Capacity (veh/h)	141	-	-	-
HCM Lane V/C Ratio	0.241	-	-	-
HCM Control Delay (s)	38.5	-	-	-
HCM Lane LOS	E	-	-	-
HCM 95th %tile Q(veh)	0.9	-	-	-

HCM 6th TWSC  
2: Aurora St & Bird Road

Intersection						
Int Delay, s/veh	0.2					
Movement	EBT	EBR	WBL	WBT	NBL	NBR
Lane Configurations	↑↑	↑		↑↑		↑
Traffic Vol, veh/h	1465	54	0	1168	0	35
Future Vol, veh/h	1465	54	0	1168	0	35
Conflicting Peds, #/hr	0	7	0	0	0	0
Sign Control	Free	Free	Free	Free	Stop	Stop
RT Channelized	-	None	-	None	-	None
Storage Length	-	208	-	-	-	0
Veh in Median Storage, #	0	-	-	0	0	-
Grade, %	0	-	-	0	0	-
Peak Hour Factor	96	96	96	96	96	96
Heavy Vehicles, %	2	2	0	3	0	3
Mvmt Flow	1526	56	0	1217	0	36

Major/Minor	Major1	Major2	Minor1		
Conflicting Flow All	0	0	-	-	770
Stage 1	-	-	-	-	-
Stage 2	-	-	-	-	-
Critical Hdwy	-	-	-	-	6.96
Critical Hdwy Stg 1	-	-	-	-	-
Critical Hdwy Stg 2	-	-	-	-	-
Follow-up Hdwy	-	-	-	-	3.33
Pot Cap-1 Maneuver	-	-	0	-	341
Stage 1	-	-	0	-	-
Stage 2	-	-	0	-	-
Platoon blocked, %	-	-	-	-	-
Mov Cap-1 Maneuver	-	-	-	-	339
Mov Cap-2 Maneuver	-	-	-	-	-
Stage 1	-	-	-	-	-
Stage 2	-	-	-	-	-

Approach	EB	WB	NB
HCM Control Delay, s	0	0	16.9
HCM LOS			C

Minor Lane/Major Mvmt	NBLn1	EBT	EBR	WBT
Capacity (veh/h)	339	-	-	-
HCM Lane V/C Ratio	0.108	-	-	-
HCM Control Delay (s)	16.9	-	-	-
HCM Lane LOS	C	-	-	-
HCM 95th %tile Q(veh)	0.4	-	-	-

HCM 6th TWSC  
3: Aurora St & Altara Ave

Intersection												
Int Delay, s/veh	2.4											
Movement	EBL	EBT	EBR	WBL	WBT	WBR	NBL	NBT	NBR	SBL	SBT	SBR
Lane Configurations		↕			↕			↕			↕	
Traffic Vol, veh/h	30	92	14	9	145	41	3	11	9	5	3	9
Future Vol, veh/h	30	92	14	9	145	41	3	11	9	5	3	9
Conflicting Peds, #/hr	8	0	5	5	0	8	0	0	4	4	0	0
Sign Control	Free	Free	Free	Free	Free	Free	Stop	Stop	Stop	Stop	Stop	Stop
RT Channelized	-	-	None	-	-	None	-	-	None	-	-	None
Storage Length	-	-	-	-	-	-	-	-	-	-	-	-
Veh in Median Storage, #	-	0	-	-	0	-	-	0	-	-	0	-
Grade, %	-	0	-	-	0	-	-	0	-	-	0	-
Peak Hour Factor	53	53	53	53	53	53	53	53	53	53	53	53
Heavy Vehicles, %	1	1	1	2	2	2	0	0	0	6	6	6
Mvmt Flow	57	174	26	17	274	77	6	21	17	9	6	17

Major/Minor	Major1			Major2			Minor1			Minor2		
Conflicting Flow All	359	0	0	205	0	0	664	699	196	679	674	321
Stage 1	-	-	-	-	-	-	306	306	-	355	355	-
Stage 2	-	-	-	-	-	-	358	393	-	324	319	-
Critical Hdwy	4.11	-	-	4.12	-	-	7.1	6.5	6.2	7.16	6.56	6.26
Critical Hdwy Stg 1	-	-	-	-	-	-	6.1	5.5	-	6.16	5.56	-
Critical Hdwy Stg 2	-	-	-	-	-	-	6.1	5.5	-	6.16	5.56	-
Follow-up Hdwy	2.209	-	-	2.218	-	-	3.5	4	3.3	3.554	4.054	3.354
Pot Cap-1 Maneuver	1205	-	-	1366	-	-	377	366	850	360	371	711
Stage 1	-	-	-	-	-	-	708	665	-	654	623	-
Stage 2	-	-	-	-	-	-	664	609	-	680	646	-
Platoon blocked, %	-	-	-	-	-	-	-	-	-	-	-	-
Mov Cap-1 Maneuver	1196	-	-	1359	-	-	342	336	843	315	341	706
Mov Cap-2 Maneuver	-	-	-	-	-	-	342	336	-	315	341	-
Stage 1	-	-	-	-	-	-	666	626	-	614	608	-
Stage 2	-	-	-	-	-	-	632	594	-	607	608	-

Approach	EB			WB			NB			SB		
HCM Control Delay, s	1.8			0.4			14.1			13.5		
HCM LOS							B			B		

Minor Lane/Major Mvmt	NBLn1	EBL	EBT	EBR	WBL	WBT	WBR	SBLn1
Capacity (veh/h)	441	1196	-	-	1359	-	-	454
HCM Lane V/C Ratio	0.098	0.047	-	-	0.012	-	-	0.071
HCM Control Delay (s)	14.1	8.2	0	-	7.7	0	-	13.5
HCM Lane LOS	B	A	A	-	A	A	-	B
HCM 95th %tile Q(veh)	0.3	0.1	-	-	0	-	-	0.2

HCM 6th TWSC  
 4: Ponce de Leon Blvd & Altara Ave

Intersection												
Int Delay, s/veh	1.3											
Movement	EBL	EBT	EBR	WBL	WBT	WBR	NBL	NBT	NBR	SBL	SBT	SBR
Lane Configurations		↕			↕			↕			↕	
Traffic Vol, veh/h	20	0	28	1	0	4	40	417	1	0	504	118
Future Vol, veh/h	20	0	28	1	0	4	40	417	1	0	504	118
Conflicting Peds, #/hr	2	0	14	14	0	2	34	0	31	31	0	34
Sign Control	Stop	Stop	Stop	Stop	Stop	Stop	Free	Free	Free	Free	Free	Free
RT Channelized	-	-	None	-	-	None	-	-	None	-	-	None
Storage Length	-	-	-	-	-	-	-	-	-	-	-	-
Veh in Median Storage, #	-	0	-	-	0	-	-	0	-	-	0	-
Grade, %	-	0	-	-	0	-	-	0	-	-	0	-
Peak Hour Factor	95	95	95	95	95	95	95	95	95	95	95	95
Heavy Vehicles, %	2	2	2	0	0	0	2	2	2	2	2	2
Mvmt Flow	21	0	29	1	0	4	42	439	1	0	531	124

Major/Minor	Minor2		Minor1		Major1				Major2			
Conflicting Flow All	933	1182	376	835	1244	253	689	0	0	471	0	0
Stage 1	627	627	-	555	555	-	-	-	-	-	-	-
Stage 2	306	555	-	280	689	-	-	-	-	-	-	-
Critical Hdwy	7.54	6.54	6.94	7.5	6.5	6.9	4.14	-	-	4.14	-	-
Critical Hdwy Stg 1	6.54	5.54	-	6.5	5.5	-	-	-	-	-	-	-
Critical Hdwy Stg 2	6.54	5.54	-	6.5	5.5	-	-	-	-	-	-	-
Follow-up Hdwy	3.52	4.02	3.32	3.5	4	3.3	2.22	-	-	2.22	-	-
Pot Cap-1 Maneuver	221	188	622	264	176	753	901	-	-	1087	-	-
Stage 1	438	474	-	489	516	-	-	-	-	-	-	-
Stage 2	679	511	-	709	450	-	-	-	-	-	-	-
Platoon blocked, %								-	-		-	-
Mov Cap-1 Maneuver	202	165	594	229	155	729	872	-	-	1055	-	-
Mov Cap-2 Maneuver	202	165	-	229	155	-	-	-	-	-	-	-
Stage 1	397	459	-	444	469	-	-	-	-	-	-	-
Stage 2	631	464	-	665	436	-	-	-	-	-	-	-

Approach	EB	WB	NB	SB
HCM Control Delay, s	18	12.2	1.1	0
HCM LOS	C	B		

Minor Lane/Major Mvmt	NBL	NBT	NBR	EBLn1	WBLn1	SBL	SBT	SBR
Capacity (veh/h)	872	-	-	328	507	1055	-	-
HCM Lane V/C Ratio	0.048	-	-	0.154	0.01	-	-	-
HCM Control Delay (s)	9.3	0.3	-	18	12.2	0	-	-
HCM Lane LOS	A	A	-	C	B	A	-	-
HCM 95th %tile Q(veh)	0.2	-	-	0.5	0	0	-	-

## Roadway Segment LOS

---

## Arterial Level of Service

---

### Arterial Level of Service: NB Ponce de Leon Blvd

---

Cross Street	Arterial Class	Flow Speed	Running Time	Signal Delay	Travel Time (s)	Dist (mi)	Arterial Speed	Arterial LOS
San Lorenzo Ave	III	30	11.2	3.3	14.5	0.08	19.8	C
Bird Road	III	30	23.7	87.2	110.9	0.19	6.1	F
Total	III		34.9	90.5	125.4	0.27	7.7	F

---

### Arterial Level of Service: SB Ponce de Leon Blvd

---

Cross Street	Arterial Class	Flow Speed	Running Time	Signal Delay	Travel Time (s)	Dist (mi)	Arterial Speed	Arterial LOS
Bird Road	III	30	24.3	77.3	101.6	0.19	6.8	F
San Lorenzo Ave	III	30	23.7	7.3	31.0	0.19	21.7	C
Total	III		48.0	84.6	132.6	0.38	10.3	E

## Arterial Level of Service

---

### Arterial Level of Service: NB LeJeune Rd

---

Cross Street	Arterial Class	Flow Speed	Running Time	Signal Delay	Travel Time (s)	Dist (mi)	Arterial Speed	Arterial LOS
Altara Ave	II	35	19.9	3.0	22.9	0.16	25.0	C
Bird Road	II	40	13.3	77.8	91.1	0.12	4.6	F
Total	II		33.2	80.8	114.0	0.28	8.7	F

---

### Arterial Level of Service: SB LeJeune Rd

---

Cross Street	Arterial Class	Flow Speed	Running Time	Signal Delay	Travel Time (s)	Dist (mi)	Arterial Speed	Arterial LOS
Bird Road	II	40	22.0	80.7	102.7	0.19	6.7	F
Altara Ave	II	35	14.5	3.1	17.6	0.12	23.7	C
Total	II		36.5	83.8	120.3	0.31	9.2	F

## Arterial Level of Service

---

### Arterial Level of Service: EB Bird Road

---

Cross Street	Arterial Class	Flow Speed	Running Time	Signal Delay	Travel Time (s)	Dist (mi)	Arterial Speed	Arterial LOS
LeJeune Rd	III	35	16.6	39.5	56.1	0.13	8.3	F
Ponce de Leon Blvd	III	35	26.3	33.2	59.5	0.22	13.2	E
Total	III		42.9	72.7	115.6	0.35	10.9	E

---

### Arterial Level of Service: WB Bird Road

---

Cross Street	Arterial Class	Flow Speed	Running Time	Signal Delay	Travel Time (s)	Dist (mi)	Arterial Speed	Arterial LOS
Ponce de Leon Blvd	III	35	18.6	37.7	56.3	0.15	9.3	F
LeJeune Rd	III	35	26.3	34.7	61.0	0.22	12.9	E
Total	III		44.9	72.4	117.3	0.36	11.2	E



## Arterial Level of Service

---

### Arterial Level of Service: WB Altara Ave

---

Cross Street	Arterial Class	Flow Speed	Running Time	Signal Delay	Travel Time (s)	Dist (mi)	Arterial Speed	Arterial LOS
LeJeune Rd	III	30	27.9	0.0	27.9	0.22	28.3	B
Total	III		27.9	0.0	27.9	0.22	28.3	B

## PM Peak Hour Existing Conditions























---

---

## Intersection LOS

---

HCM 6th Signalized Intersection Summary  
 2594: Ponce de Leon Blvd & Bird Road



















												
Movement	EBL	EBT	EBR	WBL	WBT	WBR	NBL	NBT	NBR	SBL	SBT	SBR
Lane Configurations												
Traffic Volume (veh/h)	129	1006	76	122	1512	116	98	319	64	120	401	142
Future Volume (veh/h)	129	1006	76	122	1512	116	98	319	64	120	401	142
Initial Q (Qb), veh	0	0	0	0	0	0	0	0	0	0	0	0
Ped-Bike Adj(A_pbT)	1.00		1.00	1.00		1.00	1.00		1.00	1.00		1.00
Parking Bus, Adj	1.00	1.00	1.00	1.00	1.00	1.00	1.00	1.00	1.00	1.00	1.00	1.00
Work Zone On Approach		No			No			No			No	
Adj Sat Flow, veh/h/ln	1697	1697	1697	1697	1697	1697	1683	1683	1683	1683	1683	1683
Adj Flow Rate, veh/h	133	1037	78	126	1559	120	101	329	66	124	413	146
Peak Hour Factor	0.97	0.97	0.97	0.97	0.97	0.97	0.97	0.97	0.97	0.97	0.97	0.97
Percent Heavy Veh, %	1	1	1	1	1	1	2	2	2	2	2	2
Cap, veh/h	152	1992	938	388	1901	145	123	367	73	144	512	274
Arrive On Green	0.06	1.00	1.00	0.04	0.63	0.63	0.03	0.14	0.14	0.06	0.16	0.16
Sat Flow, veh/h	1616	3224	1438	1616	3035	232	1603	2660	527	1603	3198	1427
Grp Volume(v), veh/h	133	1037	78	126	823	856	101	196	199	124	413	146
Grp Sat Flow(s),veh/h/ln	1616	1612	1438	1616	1612	1655	1603	1599	1588	1603	1599	1427
Q Serve(g_s), s	5.7	0.0	0.0	5.2	70.1	72.0	6.2	21.7	22.2	10.2	22.4	16.6
Cycle Q Clear(g_c), s	5.7	0.0	0.0	5.2	70.1	72.0	6.2	21.7	22.2	10.2	22.4	16.6
Prop In Lane	1.00		1.00	1.00		0.14	1.00		0.33	1.00		1.00
Lane Grp Cap(c), veh/h	152	1992	938	388	1010	1037	123	221	219	144	512	274
V/C Ratio(X)	0.88	0.52	0.08	0.32	0.81	0.83	0.82	0.89	0.91	0.86	0.81	0.53
Avail Cap(c_a), veh/h	152	1992	938	437	1010	1037	123	283	282	144	638	330
HCM Platoon Ratio	2.00	2.00	2.00	1.00	1.00	1.00	1.00	1.00	1.00	1.00	1.00	1.00
Upstream Filter(I)	1.00	1.00	1.00	1.00	1.00	1.00	1.00	1.00	1.00	1.00	1.00	1.00
Uniform Delay (d), s/veh	37.7	0.0	0.0	11.4	25.7	26.0	73.9	76.2	76.4	67.9	72.9	65.5
Incr Delay (d2), s/veh	38.7	1.0	0.2	0.2	7.2	7.5	33.0	22.0	25.3	36.6	5.6	1.2
Initial Q Delay(d3),s/veh	0.0	0.0	0.0	0.0	0.0	0.0	0.0	0.0	0.0	0.0	0.0	0.0
%ile BackOfQ(50%),veh/ln	5.3	0.3	0.0	1.9	28.2	29.8	3.1	10.3	10.7	2.8	9.7	6.2
Unsig. Movement Delay, s/veh												
LnGrp Delay(d),s/veh	76.3	1.0	0.2	11.6	32.9	33.5	106.8	98.2	101.8	104.6	78.5	66.7
LnGrp LOS	E	A	A	B	C	C	F	F	F	F	E	E
Approach Vol, veh/h		1248			1805			496			683	
Approach Delay, s/veh		9.0			31.7			101.4			80.7	
Approach LOS		A			C			F			F	
Timer - Assigned Phs	1	2	3	4	5	6	7	8				
Phs Duration (G+Y+Rc), s	13.6	117.5	13.0	35.9	12.0	119.1	17.0	31.9				
Change Period (Y+Rc), s	* 6.3	* 6.3	* 6.8	7.1	* 6.3	* 6.3	* 6.8	7.1				
Max Green Setting (Gmax), s	* 13	* 99	* 6.2	35.9	* 5.7	* 1.1E2	* 10	31.9				
Max Q Clear Time (g_c+I1), s	7.2	0.0	8.2	24.4	7.7	0.0	12.2	24.2				
Green Ext Time (p_c), s	0.1	0.0	0.0	1.3	0.0	0.0	0.0	0.6				
<b>Intersection Summary</b>												
HCM 6th Ctrl Delay			41.1									
HCM 6th LOS			D									
<b>Notes</b>												
* HCM 6th computational engine requires equal clearance times for the phases crossing the barrier.												

HCM 6th Signalized Intersection Summary  
 2595: LeJeune Rd & Bird Road

Movement	EBL	EBT	EBR	WBL	WBT	WBR	NBL	NBT	NBR	SBL	SBT	SBR
Lane Configurations												
Traffic Volume (veh/h)	106	958	163	133	1417	179	121	716	75	133	801	68
Future Volume (veh/h)	106	958	163	133	1417	179	121	716	75	133	801	68
Initial Q (Qb), veh	0	0	0	0	0	0	0	0	0	0	0	0
Ped-Bike Adj(A_pbT)	1.00		1.00	1.00		1.00	1.00		1.00	1.00		1.00
Parking Bus, Adj	1.00	1.00	1.00	1.00	1.00	1.00	1.00	1.00	1.00	1.00	1.00	1.00
Work Zone On Approach		No			No			No			No	
Adj Sat Flow, veh/h/ln	1885	1885	1885	1885	1885	1885	1870	1870	1870	1885	1885	1885
Adj Flow Rate, veh/h	112	1008	172	140	1492	188	127	754	79	140	843	72
Peak Hour Factor	0.95	0.95	0.95	0.95	0.95	0.95	0.95	0.95	0.95	0.95	0.95	0.95
Percent Heavy Veh, %	1	1	1	1	1	1	2	2	2	1	1	1
Cap, veh/h	239	1799	803	278	2429	306	115	877	92	137	902	77
Arrive On Green	0.03	0.50	0.50	0.10	1.00	1.00	0.05	0.36	0.36	0.03	0.27	0.27
Sat Flow, veh/h	1795	3582	1598	1795	4629	583	1781	3246	340	1795	3340	285
Grp Volume(v), veh/h	112	1008	172	140	1106	574	127	413	420	140	452	463
Grp Sat Flow(s),veh/h/ln	1795	1791	1598	1795	1716	1780	1781	1777	1809	1795	1791	1834
Q Serve(g_s), s	5.0	35.1	10.8	7.0	0.0	0.0	6.1	38.7	38.8	6.1	44.4	44.4
Cycle Q Clear(g_c), s	5.0	35.1	10.8	7.0	0.0	0.0	6.1	38.7	38.8	6.1	44.4	44.4
Prop In Lane	1.00		1.00	1.00		0.33	1.00		0.19	1.00		0.16
Lane Grp Cap(c), veh/h	239	1799	803	278	1801	934	115	480	489	137	484	495
V/C Ratio(X)	0.47	0.56	0.21	0.50	0.61	0.61	1.11	0.86	0.86	1.02	0.93	0.93
Avail Cap(c_a), veh/h	239	1799	803	307	1801	934	115	583	594	137	588	602
HCM Platoon Ratio	1.00	1.00	1.00	2.00	2.00	2.00	1.33	1.33	1.33	1.00	1.00	1.00
Upstream Filter(l)	1.00	1.00	1.00	1.00	1.00	1.00	0.95	0.95	0.95	1.00	1.00	1.00
Uniform Delay (d), s/veh	21.3	31.0	25.0	23.0	0.0	0.0	62.1	54.5	54.5	65.8	64.1	64.1
Incr Delay (d2), s/veh	1.7	1.3	0.6	0.5	1.6	3.0	113.2	9.9	9.8	82.5	19.8	19.5
Initial Q Delay(d3),s/veh	0.0	0.0	0.0	0.0	0.0	0.0	0.0	0.0	0.0	0.0	0.0	0.0
%ile BackOfQ(50%),veh/ln	2.5	15.6	4.3	2.8	0.4	0.8	6.0	17.8	18.1	6.5	22.7	23.2
Unsig. Movement Delay, s/veh												
LnGrp Delay(d),s/veh	23.1	32.3	25.6	23.5	1.6	3.0	175.4	64.4	64.3	148.2	83.9	83.6
LnGrp LOS	C	C	C	C	A	A	F	E	E	F	F	F
Approach Vol, veh/h		1292			1820			960			1055	
Approach Delay, s/veh		30.6			3.7			79.0			92.3	
Approach LOS		C			A			E			F	
Timer - Assigned Phs	1	2	3	4	5	6	7	8				
Phs Duration (G+Y+Rc), s	15.1	96.4	13.0	55.5	11.0	100.5	13.0	55.5				
Change Period (Y+Rc), s	6.0	6.0	6.9	6.9	6.0	6.0	6.9	6.9				
Max Green Setting (Gmax), s	12.0	77.0	6.1	59.1	5.0	84.0	6.1	59.1				
Max Q Clear Time (g_c+I1), s	9.0	0.0	8.1	46.4	7.0	0.0	8.1	40.8				
Green Ext Time (p_c), s	0.0	0.0	0.0	2.3	0.0	0.0	0.0	2.2				
<b>Intersection Summary</b>												
HCM 6th Ctrl Delay			42.8									
HCM 6th LOS			D									

# HCM 6th Signalized Intersection Summary

## 3272: LeJeune Rd & Altara Ave

												
Movement	EBL	EBT	EBR	WBL	WBT	WBR	NBL	NBT	NBR	SBL	SBT	SBR
Lane Configurations												
Traffic Volume (veh/h)	0	0	0	104	0	90	0	824	60	70	1011	0
Future Volume (veh/h)	0	0	0	104	0	90	0	824	60	70	1011	0
Initial Q (Qb), veh	0	0	0	0	0	0	0	0	0	0	0	0
Ped-Bike Adj(A_pbT)	1.00		1.00	1.00		1.00	1.00		1.00	1.00		1.00
Parking Bus, Adj	1.00	1.00	1.00	1.00	1.00	1.00	1.00	1.00	1.00	1.00	1.00	1.00
Work Zone On Approach		No			No			No			No	
Adj Sat Flow, veh/h/ln	1870	1870	1870	1885	1885	1885	1885	1885	1885	1885	1885	0
Adj Flow Rate, veh/h	0	0	0	109	0	95	0	867	63	74	1064	0
Peak Hour Factor	0.95	0.95	0.95	0.95	0.95	0.95	0.95	0.95	0.95	0.95	0.95	0.95
Percent Heavy Veh, %	2	2	2	1	1	1	1	1	1	1	1	0
Cap, veh/h	0	277	0	149	1	104	40	2653	193	470	2807	0
Arrive On Green	0.00	0.00	0.00	0.15	0.00	0.15	0.00	0.78	0.78	1.00	1.00	0.00
Sat Flow, veh/h	0	1870	0	797	7	701	535	3386	246	606	3676	0
Grp Volume(v), veh/h	0	0	0	204	0	0	0	459	471	74	1064	0
Grp Sat Flow(s),veh/h/ln	0	1870	0	1504	0	0	535	1791	1841	606	1791	0
Q Serve(g_s), s	0.0	0.0	0.0	23.9	0.0	0.0	0.0	13.4	13.4	2.5	0.0	0.0
Cycle Q Clear(g_c), s	0.0	0.0	0.0	24.1	0.0	0.0	0.0	13.4	13.4	15.9	0.0	0.0
Prop In Lane	0.00		0.00	0.53		0.47	1.00		0.13	1.00		0.00
Lane Grp Cap(c), veh/h	0	277	0	253	0	0	40	1403	1443	470	2807	0
V/C Ratio(X)	0.00	0.00	0.00	0.80	0.00	0.00	0.00	0.33	0.33	0.16	0.38	0.00
Avail Cap(c_a), veh/h	0	464	0	404	0	0	40	1403	1443	470	2807	0
HCM Platoon Ratio	1.00	1.00	1.00	1.00	1.00	1.00	1.00	1.00	1.00	2.00	2.00	1.00
Upstream Filter(l)	0.00	0.00	0.00	1.00	0.00	0.00	0.00	1.00	1.00	0.57	0.57	0.00
Uniform Delay (d), s/veh	0.0	0.0	0.0	75.6	0.0	0.0	0.0	5.7	5.7	0.8	0.0	0.0
Incr Delay (d2), s/veh	0.0	0.0	0.0	6.1	0.0	0.0	0.0	0.6	0.6	0.4	0.2	0.0
Initial Q Delay(d3),s/veh	0.0	0.0	0.0	0.0	0.0	0.0	0.0	0.0	0.0	0.0	0.0	0.0
%ile BackOfQ(50%),veh/ln	0.0	0.0	0.0	9.8	0.0	0.0	0.0	5.0	5.1	0.1	0.1	0.0
Unsig. Movement Delay, s/veh												
LnGrp Delay(d),s/veh	0.0	0.0	0.0	81.7	0.0	0.0	0.0	6.3	6.3	1.2	0.2	0.0
LnGrp LOS	A	A	A	F	A	A	A	A	A	A	A	A
Approach Vol, veh/h		0			204			930			1138	
Approach Delay, s/veh		0.0			81.7			6.3			0.3	
Approach LOS					F			A			A	
Timer - Assigned Phs		2		4		6		8				
Phs Duration (G+Y+Rc), s		147.0		33.0		147.0		33.0				
Change Period (Y+Rc), s		6.0		* 6.3		6.0		* 6.3				
Max Green Setting (Gmax), s		123.0		* 45		123.0		* 45				
Max Q Clear Time (g_c+I1), s		0.0		0.0		0.0		26.1				
Green Ext Time (p_c), s		0.0		0.0		0.0		0.6				
<b>Intersection Summary</b>												
HCM 6th Ctrl Delay				10.0								
HCM 6th LOS				B								
<b>Notes</b>												
* HCM 6th computational engine requires equal clearance times for the phases crossing the barrier.												

HCM 6th Signalized Intersection Summary  
 6165: Ponce de Leon Blvd & San Lorenzo Ave



Movement	EBL	EBR	NBL	NBT	SBT	SBR
Lane Configurations						
Traffic Volume (veh/h)	24	44	60	427	453	74
Future Volume (veh/h)	24	44	60	427	453	74
Initial Q (Qb), veh	0	0	0	0	0	0
Ped-Bike Adj(A_pbT)	1.00	1.00	1.00			1.00
Parking Bus, Adj	1.00	1.00	1.00	1.00	1.00	1.00
Work Zone On Approach	No			No	No	
Adj Sat Flow, veh/h/ln	1900	1900	1870	1870	1870	1870
Adj Flow Rate, veh/h	25	45	62	440	467	76
Peak Hour Factor	0.97	0.97	0.97	0.97	0.97	0.97
Percent Heavy Veh, %	0	0	2	2	2	2
Cap, veh/h	41	74	673	2734	1972	319
Arrive On Green	0.07	0.07	0.05	0.77	0.64	0.64
Sat Flow, veh/h	591	1064	1781	3647	3156	496
Grp Volume(v), veh/h	71	0	62	440	270	273
Grp Sat Flow(s),veh/h/ln	1679	0	1781	1777	1777	1781
Q Serve(g_s), s	3.3	0.0	0.8	2.6	5.1	5.2
Cycle Q Clear(g_c), s	3.3	0.0	0.8	2.6	5.1	5.2
Prop In Lane	0.35	0.63	1.00			0.28
Lane Grp Cap(c), veh/h	117	0	673	2734	1144	1147
V/C Ratio(X)	0.61	0.00	0.09	0.16	0.24	0.24
Avail Cap(c_a), veh/h	371	0	717	2734	1144	1147
HCM Platoon Ratio	1.00	1.00	1.00	1.00	1.00	1.00
Upstream Filter(I)	1.00	0.00	1.00	1.00	1.00	1.00
Uniform Delay (d), s/veh	36.2	0.0	3.7	2.4	6.0	6.0
Incr Delay (d2), s/veh	3.8	0.0	0.0	0.1	0.5	0.5
Initial Q Delay(d3),s/veh	0.0	0.0	0.0	0.0	0.0	0.0
%ile BackOfQ(50%),veh/ln	1.5	0.0	0.2	0.6	1.8	1.8
Unsig. Movement Delay, s/veh						
LnGrp Delay(d),s/veh	39.9	0.0	3.7	2.6	6.5	6.5
LnGrp LOS	D	A	A	A	A	A
Approach Vol, veh/h	71			502	543	
Approach Delay, s/veh	39.9			2.7	6.5	
Approach LOS	D			A	A	
Timer - Assigned Phs		2		4	5	6
Phs Duration (G+Y+Rc), s		68.1		11.9	10.0	58.1
Change Period (Y+Rc), s		6.6		* 6.3	* 6.3	6.6
Max Green Setting (Gmax), s		49.4		* 18	* 5.7	37.4
Max Q Clear Time (g_c+I1), s		0.0		5.3	2.8	0.0
Green Ext Time (p_c), s		0.0		0.1	0.0	0.0
<b>Intersection Summary</b>						
HCM 6th Ctrl Delay			6.9			
HCM 6th LOS			A			
<b>Notes</b>						
* HCM 6th computational engine requires equal clearance times for the phases crossing the barrier.						

HCM 6th TWSC  
 1: Salzedo St & Bird Road

Intersection						
Int Delay, s/veh	0.8					
Movement	EBT	EBR	WBL	WBT	NBL	NBR
Lane Configurations	↑↑	↑		↑↑↑	↑	
Traffic Vol, veh/h	1131	50	0	1737	24	34
Future Vol, veh/h	1131	50	0	1737	24	34
Conflicting Peds, #/hr	0	12	0	0	0	0
Sign Control	Free	Free	Free	Free	Stop	Stop
RT Channelized	-	None	-	None	-	None
Storage Length	-	208	-	-	0	-
Veh in Median Storage, #	0	-	-	0	0	-
Grade, %	0	-	-	0	0	-
Peak Hour Factor	97	97	97	97	97	97
Heavy Vehicles, %	1	1	1	1	2	2
Mvmt Flow	1166	52	0	1791	25	35

Major/Minor	Major1	Major2	Minor1		
Conflicting Flow All	0	0	-	-	1894 595
Stage 1	-	-	-	-	1178 -
Stage 2	-	-	-	-	716 -
Critical Hdwy	-	-	-	-	6.29 6.94
Critical Hdwy Stg 1	-	-	-	-	5.84 -
Critical Hdwy Stg 2	-	-	-	-	6.04 -
Follow-up Hdwy	-	-	-	-	3.67 3.32
Pot Cap-1 Maneuver	-	-	0	-	81 447
Stage 1	-	-	0	-	249 -
Stage 2	-	-	0	-	416 -
Platoon blocked, %	-	-	-	-	
Mov Cap-1 Maneuver	-	-	-	-	80 442
Mov Cap-2 Maneuver	-	-	-	-	80 -
Stage 1	-	-	-	-	246 -
Stage 2	-	-	-	-	416 -

Approach	EB	WB	NB
HCM Control Delay, s	0	0	42.5
HCM LOS			E

Minor Lane/Major Mvmt	NBLn1	EBT	EBR	WBT
Capacity (veh/h)	154	-	-	-
HCM Lane V/C Ratio	0.388	-	-	-
HCM Control Delay (s)	42.5	-	-	-
HCM Lane LOS	E	-	-	-
HCM 95th %tile Q(veh)	1.7	-	-	-



HCM 6th TWSC  
2: Aurora St & Bird Road

Intersection						
Int Delay, s/veh	0.4					
Movement	EBT	EBR	WBL	WBT	NBL	NBR
Lane Configurations	↑↑	↑		↑↑		↑
Traffic Vol, veh/h	1146	29	0	1728	0	82
Future Vol, veh/h	1146	29	0	1728	0	82
Conflicting Peds, #/hr	0	10	0	0	0	0
Sign Control	Free	Free	Free	Free	Stop	Stop
RT Channelized	-	None	-	None	-	None
Storage Length	-	208	-	-	-	0
Veh in Median Storage, #	0	-	-	0	0	-
Grade, %	0	-	-	0	0	-
Peak Hour Factor	97	97	97	97	97	92
Heavy Vehicles, %	1	1	1	1	5	5
Mvmt Flow	1181	30	0	1781	0	89

Major/Minor	Major1	Major2	Minor1		
Conflicting Flow All	0	0	-	-	601
Stage 1	-	-	-	-	-
Stage 2	-	-	-	-	-
Critical Hdwy	-	-	-	-	7
Critical Hdwy Stg 1	-	-	-	-	-
Critical Hdwy Stg 2	-	-	-	-	-
Follow-up Hdwy	-	-	-	-	3.35
Pot Cap-1 Maneuver	-	-	0	-	436
Stage 1	-	-	0	-	-
Stage 2	-	-	0	-	-
Platoon blocked, %	-	-	-	-	-
Mov Cap-1 Maneuver	-	-	-	-	432
Mov Cap-2 Maneuver	-	-	-	-	-
Stage 1	-	-	-	-	-
Stage 2	-	-	-	-	-

Approach	EB	WB	NB
HCM Control Delay, s	0	0	15.5
HCM LOS			C

Minor Lane/Major Mvmt	NBLn1	EBT	EBR	WBT
Capacity (veh/h)	432	-	-	-
HCM Lane V/C Ratio	0.206	-	-	-
HCM Control Delay (s)	15.5	-	-	-
HCM Lane LOS	C	-	-	-
HCM 95th %tile Q(veh)	0.8	-	-	-

HCM 6th TWSC  
 3: Ponce de Leon Blvd & Altara Ave

Intersection												
Int Delay, s/veh	2.2											
Movement	EBL	EBT	EBR	WBL	WBT	WBR	NBL	NBT	NBR	SBL	SBT	SBR
Lane Configurations		↕			↕			↕			↕	
Traffic Vol, veh/h	44	0	57	1	0	3	37	429	2	2	490	98
Future Vol, veh/h	44	0	57	1	0	3	37	429	2	2	490	98
Conflicting Peds, #/hr	2	0	18	18	0	2	37	0	39	39	0	37
Sign Control	Stop	Stop	Stop	Stop	Stop	Stop	Free	Free	Free	Free	Free	Free
RT Channelized	-	-	None	-	-	None	-	-	None	-	-	None
Storage Length	-	-	-	-	-	-	-	-	-	-	-	-
Veh in Median Storage, #	-	0	-	-	0	-	-	0	-	-	0	-
Grade, %	-	0	-	-	0	-	-	0	-	-	0	-
Peak Hour Factor	95	95	95	95	95	95	95	95	95	95	95	95
Heavy Vehicles, %	1	1	1	0	0	0	2	2	2	2	2	2
Mvmt Flow	46	0	60	1	0	3	39	452	2	2	516	103

Major/Minor	Minor2		Minor1		Major1				Major2			
Conflicting Flow All	915	1180	365	850	1230	268	656	0	0	493	0	0
Stage 1	609	609	-	570	570	-	-	-	-	-	-	-
Stage 2	306	571	-	280	660	-	-	-	-	-	-	-
Critical Hdwy	7.52	6.52	6.92	7.5	6.5	6.9	4.14	-	-	4.14	-	-
Critical Hdwy Stg 1	6.52	5.52	-	6.5	5.5	-	-	-	-	-	-	-
Critical Hdwy Stg 2	6.52	5.52	-	6.5	5.5	-	-	-	-	-	-	-
Follow-up Hdwy	3.51	4.01	3.31	3.5	4	3.3	2.22	-	-	2.22	-	-
Pot Cap-1 Maneuver	229	190	635	257	179	736	927	-	-	1067	-	-
Stage 1	451	486	-	479	509	-	-	-	-	-	-	-
Stage 2	682	506	-	709	463	-	-	-	-	-	-	-
Platoon blocked, %								-	-	-	-	-
Mov Cap-1 Maneuver	209	166	602	209	156	707	894	-	-	1027	-	-
Mov Cap-2 Maneuver	209	166	-	209	156	-	-	-	-	-	-	-
Stage 1	410	468	-	434	462	-	-	-	-	-	-	-
Stage 2	638	459	-	626	445	-	-	-	-	-	-	-

Approach	EB		WB		NB				SB	
HCM Control Delay, s	20.9		13.2		0.9				0	
HCM LOS	C		B							

Minor Lane/Major Mvmt	NBL	NBT	NBR	EBLn1	WBLn1	SBL	SBT	SBR
Capacity (veh/h)	894	-	-	331	443	1027	-	-
HCM Lane V/C Ratio	0.044	-	-	0.321	0.01	0.002	-	-
HCM Control Delay (s)	9.2	0.2	-	20.9	13.2	8.5	0	-
HCM Lane LOS	A	A	-	C	B	A	A	-
HCM 95th %tile Q(veh)	0.1	-	-	1.4	0	0	-	-

HCM 6th TWSC  
4: Aurora St & Altara Ave

Intersection												
Int Delay, s/veh	5.8											
Movement	EBL	EBT	EBR	WBL	WBT	WBR	NBL	NBT	NBR	SBL	SBT	SBR
Lane Configurations		↕			↕			↕			↕	
Traffic Vol, veh/h	21	37	40	13	88	36	21	21	22	43	15	84
Future Vol, veh/h	21	37	40	13	88	36	21	21	22	43	15	84
Conflicting Peds, #/hr	6	0	23	23	0	6	8	0	30	30	0	8
Sign Control	Free	Free	Free	Free	Free	Free	Stop	Stop	Stop	Stop	Stop	Stop
RT Channelized	-	-	None	-	-	None	-	-	None	-	-	None
Storage Length	-	-	-	-	-	-	-	-	-	-	-	-
Veh in Median Storage, #	-	0	-	-	0	-	-	0	-	-	0	-
Grade, %	-	0	-	-	0	-	-	0	-	-	0	-
Peak Hour Factor	93	93	93	93	93	93	93	93	93	93	93	93
Heavy Vehicles, %	0	0	0	1	1	1	0	0	0	1	1	1
Mvmt Flow	23	40	43	14	95	39	23	23	24	46	16	90

Major/Minor	Major1			Major2			Minor1			Minor2		
Conflicting Flow All	140	0	0	106	0	0	335	299	115	310	301	129
Stage 1	-	-	-	-	-	-	131	131	-	149	149	-
Stage 2	-	-	-	-	-	-	204	168	-	161	152	-
Critical Hdwy	4.1	-	-	4.11	-	-	7.1	6.5	6.2	7.11	6.51	6.21
Critical Hdwy Stg 1	-	-	-	-	-	-	6.1	5.5	-	6.11	5.51	-
Critical Hdwy Stg 2	-	-	-	-	-	-	6.1	5.5	-	6.11	5.51	-
Follow-up Hdwy	2.2	-	-	2.209	-	-	3.5	4	3.3	3.509	4.009	3.309
Pot Cap-1 Maneuver	1456	-	-	1491	-	-	622	616	943	644	613	924
Stage 1	-	-	-	-	-	-	877	792	-	856	776	-
Stage 2	-	-	-	-	-	-	803	763	-	843	774	-
Platoon blocked, %	-	-	-	-	-	-	-	-	-	-	-	-
Mov Cap-1 Maneuver	1448	-	-	1458	-	-	522	583	896	576	580	912
Mov Cap-2 Maneuver	-	-	-	-	-	-	522	583	-	576	580	-
Stage 1	-	-	-	-	-	-	843	761	-	836	764	-
Stage 2	-	-	-	-	-	-	696	751	-	760	744	-

Approach	EB			WB			NB			SB		
HCM Control Delay, s	1.6			0.7			11.4			11.2		
HCM LOS							B			B		

Minor Lane/Major Mvmt	NBLn1	EBL	EBT	EBR	WBL	WBT	WBR	SBLn1
Capacity (veh/h)	635	1448	-	-	1458	-	-	737
HCM Lane V/C Ratio	0.108	0.016	-	-	0.01	-	-	0.207
HCM Control Delay (s)	11.4	7.5	0	-	7.5	0	-	11.2
HCM Lane LOS	B	A	A	-	A	A	-	B
HCM 95th %tile Q(veh)	0.4	0	-	-	0	-	-	0.8

## Roadway Segment LOS

---

## Arterial Level of Service

---

### Arterial Level of Service: NB Ponce de Leon Blvd

---

Cross Street	Arterial Class	Flow Speed	Running Time	Signal Delay	Travel Time (s)	Dist (mi)	Arterial Speed	Arterial LOS
San Lorenzo Ave	III	30	11.2	3.8	15.0	0.08	19.1	C
Bird Road	III	30	23.7	88.5	112.2	0.19	6.0	F
Total	III		34.9	92.3	127.2	0.27	7.5	F

---

### Arterial Level of Service: SB Ponce de Leon Blvd

---

Cross Street	Arterial Class	Flow Speed	Running Time	Signal Delay	Travel Time (s)	Dist (mi)	Arterial Speed	Arterial LOS
Bird Road	III	30	24.3	80.4	104.7	0.19	6.6	F
San Lorenzo Ave	III	30	23.7	8.2	31.9	0.19	21.1	C
Total	III		48.0	88.6	136.6	0.38	10.0	F

## Arterial Level of Service

---

### Arterial Level of Service: NB LeJeune Rd

---

Cross Street	Arterial Class	Flow Speed	Running Time	Signal Delay	Travel Time (s)	Dist (mi)	Arterial Speed	Arterial LOS
Altara Ave	II	35	19.9	7.0	26.9	0.16	21.3	D
Bird Road	II	40	13.3	62.0	75.3	0.12	5.5	F
Total	II		33.2	69.0	102.2	0.28	9.7	F

---

### Arterial Level of Service: SB LeJeune Rd

---

Cross Street	Arterial Class	Flow Speed	Running Time	Signal Delay	Travel Time (s)	Dist (mi)	Arterial Speed	Arterial LOS
Bird Road	II	40	22.0	72.5	94.5	0.19	7.3	F
	II	35	14.5	1.9	16.4	0.12	25.4	C
Total	II		36.5	74.4	110.9	0.31	10.0	F

## Arterial Level of Service

---

### Arterial Level of Service: EB Bird Road

---

Cross Street	Arterial Class	Flow Speed	Running Time	Signal Delay	Travel Time (s)	Dist (mi)	Arterial Speed	Arterial LOS
LeJeune Rd	III	35	16.6	36.9	53.5	0.13	8.7	F
Ponce de Leon Blvd	III	35	26.3	7.9	34.2	0.22	23.0	C
Total	III		42.9	44.8	87.7	0.35	14.3	D

---

### Arterial Level of Service: WB Bird Road

---

Cross Street	Arterial Class	Flow Speed	Running Time	Signal Delay	Travel Time (s)	Dist (mi)	Arterial Speed	Arterial LOS
Ponce de Leon Blvd	III	35	18.6	40.0	58.6	0.15	8.9	F
LeJeune Rd	III	35	26.3	41.4	67.7	0.22	11.6	E
Total	III		44.9	81.4	126.3	0.36	10.4	E

## Arterial Level of Service

---

### Arterial Level of Service: WB Altara Ave

---

Cross Street	Arterial Class	Flow Speed	Running Time	Signal Delay	Travel Time (s)	Dist (mi)	Arterial Speed	Arterial LOS
LeJeune Rd	III	30	27.9	0.0	27.9	0.22	28.3	B
Total	III		27.9	0.0	27.9	0.22	28.3	B

























## AM Peak Hour Future without Proposed Development Conditions

---

























## Intersection LOS

---

HCM 6th Signalized Intersection Summary  
 2594: Ponce de Leon Blvd & Bird Road



















												
Movement	EBL	EBT	EBR	WBL	WBT	WBR	NBL	NBT	NBR	SBL	SBT	SBR
Lane Configurations												
Traffic Volume (veh/h)	188	1233	115	168	1090	183	51	353	47	165	412	59
Future Volume (veh/h)	188	1233	115	168	1090	183	51	353	47	165	412	59
Initial Q (Qb), veh	0	0	0	0	0	0	0	0	0	0	0	0
Ped-Bike Adj(A_pbT)	1.00		1.00	1.00		1.00	1.00		1.00	1.00		1.00
Parking Bus, Adj	1.00	1.00	1.00	1.00	1.00	1.00	1.00	1.00	1.00	1.00	1.00	1.00
Work Zone On Approach		No			No			No			No	
Adj Sat Flow, veh/h/ln	1670	1670	1670	1683	1683	1683	1670	1670	1670	1683	1683	1683
Adj Flow Rate, veh/h	198	1298	121	177	1147	193	54	372	49	174	434	62
Peak Hour Factor	0.95	0.95	0.95	0.95	0.95	0.95	0.95	0.95	0.95	0.95	0.95	0.95
Percent Heavy Veh, %	3	3	3	2	2	2	3	3	3	2	2	2
Cap, veh/h	236	1825	867	228	1559	261	143	413	54	171	584	352
Arrive On Green	0.06	0.58	0.58	0.06	0.57	0.57	0.04	0.15	0.15	0.07	0.18	0.18
Sat Flow, veh/h	1590	3173	1415	1603	2741	459	1590	2821	369	1603	3198	1427
Grp Volume(v), veh/h	198	1298	121	177	667	673	54	208	213	174	434	62
Grp Sat Flow(s),veh/h/ln	1590	1586	1415	1603	1599	1601	1590	1586	1604	1603	1599	1427
Q Serve(g_s), s	9.4	52.9	6.5	8.3	55.6	56.3	5.2	23.2	23.5	13.2	23.1	6.2
Cycle Q Clear(g_c), s	9.4	52.9	6.5	8.3	55.6	56.3	5.2	23.2	23.5	13.2	23.1	6.2
Prop In Lane	1.00		1.00	1.00		0.29	1.00		0.23	1.00		1.00
Lane Grp Cap(c), veh/h	236	1825	867	228	909	910	143	232	235	171	584	352
V/C Ratio(X)	0.84	0.71	0.14	0.78	0.73	0.74	0.38	0.90	0.91	1.02	0.74	0.18
Avail Cap(c_a), veh/h	307	1825	867	249	909	910	200	325	329	171	656	384
HCM Platoon Ratio	1.00	1.00	1.00	1.00	1.00	1.00	1.00	1.00	1.00	1.00	1.00	1.00
Upstream Filter(l)	1.00	1.00	1.00	1.00	1.00	1.00	1.00	1.00	1.00	1.00	1.00	1.00
Uniform Delay (d), s/veh	32.1	27.5	14.8	29.5	28.7	28.9	62.9	75.5	75.6	66.1	69.6	53.4
Incr Delay (d2), s/veh	11.9	2.4	0.3	11.4	5.2	5.4	0.6	18.8	20.6	73.2	3.7	0.2
Initial Q Delay(d3),s/veh	0.0	0.0	0.0	0.0	0.0	0.0	0.0	0.0	0.0	0.0	0.0	0.0
%ile BackOfQ(50%),veh/ln	5.8	20.5	2.3	4.9	22.5	22.8	2.1	10.7	11.1	5.7	9.8	2.3
Unsig. Movement Delay, s/veh												
LnGrp Delay(d),s/veh	44.0	29.9	15.1	41.0	34.0	34.2	63.5	94.2	96.2	139.3	73.3	53.5
LnGrp LOS	D	C	B	D	C	C	E	F	F	F	E	D
Approach Vol, veh/h		1617			1517			475			670	
Approach Delay, s/veh		30.5			34.9			91.6			88.6	
Approach LOS		C			C			F			F	
Timer - Assigned Phs	1	2	3	4	5	6	7	8				
Phs Duration (G+Y+Rc), s	16.7	109.9	13.5	39.9	17.9	108.7	20.0	33.4				
Change Period (Y+Rc), s	* 6.3	* 6.3	* 6.8	7.1	* 6.3	* 6.3	* 6.8	7.1				
Max Green Setting (Gmax), s	* 13	* 91	* 13	36.9	* 20	* 84	* 13	36.9				
Max Q Clear Time (g_c+I1), s	10.3	0.0	7.2	25.1	11.4	0.0	15.2	25.5				
Green Ext Time (p_c), s	0.1	0.0	0.0	1.2	0.2	0.0	0.0	0.8				
<b>Intersection Summary</b>												
HCM 6th Ctrl Delay				47.9								
HCM 6th LOS				D								
<b>Notes</b>												
* HCM 6th computational engine requires equal clearance times for the phases crossing the barrier.												

HCM 6th Signalized Intersection Summary  
 2595: LeJeune Rd & Bird Road

												
Movement	EBL	EBT	EBR	WBL	WBT	WBR	NBL	NBT	NBR	SBL	SBT	SBR
Lane Configurations												
Traffic Volume (veh/h)	181	1376	168	84	961	140	141	796	40	147	730	53
Future Volume (veh/h)	181	1376	168	84	961	140	141	796	40	147	730	53
Initial Q (Qb), veh	0	0	0	0	0	0	0	0	0	0	0	0
Ped-Bike Adj(A_pbT)	1.00		1.00	1.00		1.00	1.00		1.00	1.00		1.00
Parking Bus, Adj	1.00	1.00	1.00	1.00	1.00	1.00	1.00	1.00	1.00	1.00	1.00	1.00
Work Zone On Approach		No			No			No			No	
Adj Sat Flow, veh/h/ln	1856	1856	1856	1856	1856	1856	1870	1870	1870	1856	1856	1856
Adj Flow Rate, veh/h	183	1390	170	85	971	141	142	804	40	148	737	54
Peak Hour Factor	0.99	0.99	0.99	0.99	0.99	0.99	0.99	0.99	0.99	0.99	0.99	0.99
Percent Heavy Veh, %	3	3	3	3	3	3	2	2	2	3	3	3
Cap, veh/h	327	1837	820	168	2199	318	178	852	42	155	784	57
Arrive On Green	0.06	0.52	0.52	0.03	0.49	0.49	0.07	0.25	0.25	0.06	0.24	0.24
Sat Flow, veh/h	1767	3526	1572	1767	4469	647	1781	3445	171	1767	3330	244
Grp Volume(v), veh/h	183	1390	170	85	733	379	142	415	429	148	390	401
Grp Sat Flow(s),veh/h/ln	1767	1763	1572	1767	1689	1739	1781	1777	1840	1767	1763	1812
Q Serve(g_s), s	9.4	58.3	10.9	4.5	26.3	26.5	11.2	42.8	42.9	11.1	40.6	40.6
Cycle Q Clear(g_c), s	9.4	58.3	10.9	4.5	26.3	26.5	11.2	42.8	42.9	11.1	40.6	40.6
Prop In Lane	1.00		1.00	1.00		0.37	1.00		0.09	1.00		0.13
Lane Grp Cap(c), veh/h	327	1837	820	168	1662	856	178	439	455	155	415	427
V/C Ratio(X)	0.56	0.76	0.21	0.51	0.44	0.44	0.80	0.94	0.94	0.95	0.94	0.94
Avail Cap(c_a), veh/h	404	1837	820	173	1662	856	222	467	483	155	463	476
HCM Platoon Ratio	1.00	1.00	1.00	1.00	1.00	1.00	1.00	1.00	1.00	1.00	1.00	1.00
Upstream Filter(l)	1.00	1.00	1.00	1.00	1.00	1.00	0.94	0.94	0.94	1.00	1.00	1.00
Uniform Delay (d), s/veh	23.2	35.4	24.0	32.1	30.8	30.8	53.9	69.1	69.1	58.2	70.2	70.2
Incr Delay (d2), s/veh	1.8	3.0	0.6	0.9	0.9	1.7	11.3	26.0	25.5	58.0	25.7	25.4
Initial Q Delay(d3),s/veh	0.0	0.0	0.0	0.0	0.0	0.0	0.0	0.0	0.0	0.0	0.0	0.0
%ile BackOfQ(50%),veh/ln	4.2	25.7	4.2	2.0	11.1	11.7	5.6	22.5	23.2	7.9	21.2	21.7
Unsig. Movement Delay, s/veh												
LnGrp Delay(d),s/veh	25.0	38.4	24.6	33.0	31.7	32.5	65.2	95.1	94.6	116.2	95.9	95.6
LnGrp LOS	C	D	C	C	C	C	E	F	F	F	F	F
Approach Vol, veh/h		1743			1197			986			939	
Approach Delay, s/veh		35.6			32.0			90.6			98.9	
Approach LOS		D			C			F			F	
Timer - Assigned Phs	1	2	3	4	5	6	7	8				
Phs Duration (G+Y+Rc), s	12.4	103.5	20.2	50.9	17.9	98.0	18.0	53.1				
Change Period (Y+Rc), s	6.0	6.0	6.9	6.9	6.0	6.0	6.9	6.9				
Max Green Setting (Gmax), s	7.0	87.0	18.0	49.1	20.0	74.0	11.1	49.1				
Max Q Clear Time (g_c+I1), s	6.5	0.0	13.2	42.6	11.4	0.0	13.1	44.9				
Green Ext Time (p_c), s	0.0	0.0	0.1	1.4	0.4	0.0	0.0	1.1				
<b>Intersection Summary</b>												
HCM 6th Ctrl Delay			58.1									
HCM 6th LOS			E									

# HCM 6th Signalized Intersection Summary

## 3272: LeJeune Rd & Altara Ave

												
Movement	EBL	EBT	EBR	WBL	WBT	WBR	NBL	NBT	NBR	SBL	SBT	SBR
Lane Configurations												
Traffic Volume (veh/h)	0	0	0	83	0	123	0	878	67	62	929	0
Future Volume (veh/h)	0	0	0	83	0	123	0	878	67	62	929	0
Initial Q (Qb), veh	0	0	0	0	0	0	0	0	0	0	0	0
Ped-Bike Adj(A_pbT)	1.00		1.00	1.00		1.00	1.00		1.00	1.00		1.00
Parking Bus, Adj	1.00	1.00	1.00	1.00	1.00	1.00	1.00	1.00	1.00	1.00	1.00	1.00
Work Zone On Approach		No			No			No			No	
Adj Sat Flow, veh/h/ln	1900	1900	1900	1870	1870	1870	1870	1870	1870	1870	1870	0
Adj Flow Rate, veh/h	0	0	0	89	0	132	0	944	72	67	999	0
Peak Hour Factor	0.93	0.93	0.93	0.93	0.93	0.93	0.93	0.93	0.93	0.93	0.93	0.93
Percent Heavy Veh, %	0	0	0	2	2	2	2	2	2	2	2	0
Cap, veh/h	0	301	0	121	4	144	40	2587	197	419	2747	0
Arrive On Green	0.00	0.00	0.00	0.16	0.00	0.16	0.00	0.77	0.77	0.77	0.77	0.00
Sat Flow, veh/h	0	1900	0	584	28	908	564	3346	255	555	3647	0
Grp Volume(v), veh/h	0	0	0	221	0	0	0	501	515	67	999	0
Grp Sat Flow(s),veh/h/ln	0	1900	0	1520	0	0	564	1777	1824	555	1777	0
Q Serve(g_s), s	0.0	0.0	0.0	24.6	0.0	0.0	0.0	16.1	16.1	7.8	16.0	0.0
Cycle Q Clear(g_c), s	0.0	0.0	0.0	25.7	0.0	0.0	0.0	16.1	16.1	23.9	16.0	0.0
Prop In Lane	0.00		0.00	0.40		0.60	1.00		0.14	1.00		0.00
Lane Grp Cap(c), veh/h	0	301	0	269	0	0	40	1374	1410	419	2747	0
V/C Ratio(X)	0.00	0.00	0.00	0.82	0.00	0.00	0.00	0.36	0.36	0.16	0.36	0.00
Avail Cap(c_a), veh/h	0	875	0	726	0	0	40	1374	1410	419	2747	0
HCM Platoon Ratio	1.00	1.00	1.00	1.00	1.00	1.00	1.00	1.00	1.00	1.00	1.00	1.00
Upstream Filter(l)	0.00	0.00	0.00	1.00	0.00	0.00	0.00	1.00	1.00	0.55	0.55	0.00
Uniform Delay (d), s/veh	0.0	0.0	0.0	74.5	0.0	0.0	0.0	6.5	6.5	10.2	6.4	0.0
Incr Delay (d2), s/veh	0.0	0.0	0.0	6.2	0.0	0.0	0.0	0.8	0.7	0.4	0.2	0.0
Initial Q Delay(d3),s/veh	0.0	0.0	0.0	0.0	0.0	0.0	0.0	0.0	0.0	0.0	0.0	0.0
%ile BackOfQ(50%),veh/ln	0.0	0.0	0.0	10.6	0.0	0.0	0.0	6.0	6.2	1.0	5.8	0.0
Unsig. Movement Delay, s/veh												
LnGrp Delay(d),s/veh	0.0	0.0	0.0	80.6	0.0	0.0	0.0	7.2	7.2	10.7	6.7	0.0
LnGrp LOS	A	A	A	F	A	A	A	A	A	B	A	A
Approach Vol, veh/h		0			221			1016			1066	
Approach Delay, s/veh		0.0			80.6			7.2			6.9	
Approach LOS					F			A			A	
Timer - Assigned Phs		2		4		6		8				
Phs Duration (G+Y+Rc), s		145.2		34.8		145.2		34.8				
Change Period (Y+Rc), s		6.0		* 6.3		6.0		* 6.3				
Max Green Setting (Gmax), s		84.8		* 83		84.8		* 83				
Max Q Clear Time (g_c+I1), s		0.0		0.0		0.0		27.7				
Green Ext Time (p_c), s		0.0		0.0		0.0		0.8				
<b>Intersection Summary</b>												
HCM 6th Ctrl Delay				14.1								
HCM 6th LOS				B								
<b>Notes</b>												
* HCM 6th computational engine requires equal clearance times for the phases crossing the barrier.												

HCM 6th Signalized Intersection Summary  
 6165: Ponce de Leon Blvd & San Lorenzo Ave



Movement	EBL	EBR	NBL	NBT	SBT	SBR
Lane Configurations						
Traffic Volume (veh/h)	8	24	42	478	540	23
Future Volume (veh/h)	8	24	42	478	540	23
Initial Q (Qb), veh	0	0	0	0	0	0
Ped-Bike Adj(A_pbT)	1.00	1.00	1.00			1.00
Parking Bus, Adj	1.00	1.00	1.00	1.00	1.00	1.00
Work Zone On Approach	No			No	No	
Adj Sat Flow, veh/h/ln	1900	1900	1856	1856	1870	1870
Adj Flow Rate, veh/h	9	26	45	514	581	25
Peak Hour Factor	0.93	0.93	0.93	0.93	0.93	0.93
Percent Heavy Veh, %	0	0	3	3	2	2
Cap, veh/h	19	55	650	2787	2334	100
Arrive On Green	0.05	0.05	0.04	0.79	0.67	0.67
Sat Flow, veh/h	396	1145	1767	3618	3565	149
Grp Volume(v), veh/h	36	0	45	514	297	309
Grp Sat Flow(s),veh/h/ln	1585	0	1767	1763	1777	1844
Q Serve(g_s), s	1.8	0.0	0.6	2.9	5.3	5.3
Cycle Q Clear(g_c), s	1.8	0.0	0.6	2.9	5.3	5.3
Prop In Lane	0.25	0.72	1.00			0.08
Lane Grp Cap(c), veh/h	76	0	650	2787	1195	1239
V/C Ratio(X)	0.47	0.00	0.07	0.18	0.25	0.25
Avail Cap(c_a), veh/h	513	0	865	2787	1195	1239
HCM Platoon Ratio	1.00	1.00	1.00	1.00	1.00	1.00
Upstream Filter(I)	1.00	0.00	1.00	1.00	1.00	1.00
Uniform Delay (d), s/veh	37.1	0.0	3.2	2.1	5.2	5.2
Incr Delay (d2), s/veh	3.3	0.0	0.0	0.1	0.5	0.5
Initial Q Delay(d3),s/veh	0.0	0.0	0.0	0.0	0.0	0.0
%ile BackOfQ(50%),veh/ln	0.8	0.0	0.1	0.6	1.7	1.8
Unsig. Movement Delay, s/veh						
LnGrp Delay(d),s/veh	40.4	0.0	3.2	2.2	5.7	5.6
LnGrp LOS	D	A	A	A	A	A
Approach Vol, veh/h	36			559	606	
Approach Delay, s/veh	40.4			2.3	5.6	
Approach LOS	D			A	A	
Timer - Assigned Phs		2		4	5	6
Phs Duration (G+Y+Rc), s		69.8		10.2	9.5	60.4
Change Period (Y+Rc), s		6.6		* 6.3	* 6.3	6.6
Max Green Setting (Gmax), s		41.2		* 26	* 13	22.0
Max Q Clear Time (g_c+I1), s		0.0		3.8	2.6	0.0
Green Ext Time (p_c), s		0.0		0.1	0.0	0.0
<b>Intersection Summary</b>						
HCM 6th Ctrl Delay			5.1			
HCM 6th LOS			A			
<b>Notes</b>						
* HCM 6th computational engine requires equal clearance times for the phases crossing the barrier.						

HCM 6th TWSC  
1: Salzedo St & Bird Road

02/19/2020

Intersection						
Int Delay, s/veh	0.5					
Movement	EBT	EBR	WBL	WBT	NBL	NBR
Lane Configurations	↑↑	↑		↑↑↑	↑	
Traffic Vol, veh/h	1557	21	0	1247	12	22
Future Vol, veh/h	1557	21	0	1247	12	22
Conflicting Peds, #/hr	0	5	0	0	0	0
Sign Control	Free	Free	Free	Free	Stop	Stop
RT Channelized	-	None	-	None	-	None
Storage Length	-	208	-	-	0	-
Veh in Median Storage, #	0	-	-	0	0	-
Grade, %	0	-	-	0	0	-
Peak Hour Factor	97	97	97	97	97	97
Heavy Vehicles, %	2	2	0	3	0	0
Mvmt Flow	1605	22	0	1286	12	23

Major/Minor	Major1	Major2	Minor1		
Conflicting Flow All	0	0	-	-	2124 808
Stage 1	-	-	-	-	1610 -
Stage 2	-	-	-	-	514 -
Critical Hdwy	-	-	-	-	6.25 6.9
Critical Hdwy Stg 1	-	-	-	-	5.8 -
Critical Hdwy Stg 2	-	-	-	-	6 -
Follow-up Hdwy	-	-	-	-	3.65 3.3
Pot Cap-1 Maneuver	-	-	0	-	60 328
Stage 1	-	-	0	-	150 -
Stage 2	-	-	0	-	537 -
Platoon blocked, %	-	-	-	-	
Mov Cap-1 Maneuver	-	-	-	-	60 326
Mov Cap-2 Maneuver	-	-	-	-	60 -
Stage 1	-	-	-	-	149 -
Stage 2	-	-	-	-	537 -

Approach	EB	WB	NB
HCM Control Delay, s	0	0	43.8
HCM LOS			E

Minor Lane/Major Mvmt	NBLn1	EBT	EBR	WBT
Capacity (veh/h)	127	-	-	-
HCM Lane V/C Ratio	0.276	-	-	-
HCM Control Delay (s)	43.8	-	-	-
HCM Lane LOS	E	-	-	-
HCM 95th %tile Q(veh)	1	-	-	-

Intersection						
Int Delay, s/veh	0.2					
Movement	EBT	EBR	WBL	WBT	NBL	NBR
Lane Configurations	↑↑	↑		↑↑		↑
Traffic Vol, veh/h	1524	56	0	1215	0	36
Future Vol, veh/h	1524	56	0	1215	0	36
Conflicting Peds, #/hr	0	7	0	0	0	0
Sign Control	Free	Free	Free	Free	Stop	Stop
RT Channelized	-	None	-	None	-	None
Storage Length	-	208	-	-	-	0
Veh in Median Storage, #	0	-	-	0	0	-
Grade, %	0	-	-	0	0	-
Peak Hour Factor	96	96	96	96	96	96
Heavy Vehicles, %	2	2	0	3	0	3
Mvmt Flow	1588	58	0	1266	0	38

Major/Minor	Major1	Major2	Minor1		
Conflicting Flow All	0	0	-	-	801
Stage 1	-	-	-	-	-
Stage 2	-	-	-	-	-
Critical Hdwy	-	-	-	-	6.96
Critical Hdwy Stg 1	-	-	-	-	-
Critical Hdwy Stg 2	-	-	-	-	-
Follow-up Hdwy	-	-	-	-	3.33
Pot Cap-1 Maneuver	-	-	0	-	325
Stage 1	-	-	0	-	-
Stage 2	-	-	0	-	-
Platoon blocked, %	-	-	-	-	-
Mov Cap-1 Maneuver	-	-	-	-	323
Mov Cap-2 Maneuver	-	-	-	-	-
Stage 1	-	-	-	-	-
Stage 2	-	-	-	-	-

Approach	EB	WB	NB
HCM Control Delay, s	0	0	17.6
HCM LOS			C

Minor Lane/Major Mvmt	NBLn1	EBT	EBR	WBT
Capacity (veh/h)	323	-	-	-
HCM Lane V/C Ratio	0.116	-	-	-
HCM Control Delay (s)	17.6	-	-	-
HCM Lane LOS	C	-	-	-
HCM 95th %tile Q(veh)	0.4	-	-	-



HCM 6th TWSC  
3: Aurora St & Altara Ave

02/19/2020

Intersection												
Int Delay, s/veh	2.4											
Movement	EBL	EBT	EBR	WBL	WBT	WBR	NBL	NBT	NBR	SBL	SBT	SBR
Lane Configurations		↕			↕			↕			↕	
Traffic Vol, veh/h	31	96	15	9	151	43	3	11	9	9	3	5
Future Vol, veh/h	31	96	15	9	151	43	3	11	9	9	3	5
Conflicting Peds, #/hr	8	0	5	5	0	8	0	0	4	4	0	0
Sign Control	Free	Free	Free	Free	Free	Free	Stop	Stop	Stop	Stop	Stop	Stop
RT Channelized	-	-	None	-	-	None	-	-	None	-	-	None
Storage Length	-	-	-	-	-	-	-	-	-	-	-	-
Veh in Median Storage, #	-	0	-	-	0	-	-	0	-	-	0	-
Grade, %	-	0	-	-	0	-	-	0	-	-	0	-
Peak Hour Factor	53	53	53	53	53	53	53	53	53	53	53	53
Heavy Vehicles, %	1	1	1	2	2	2	0	0	0	6	6	6
Mvmt Flow	58	181	28	17	285	81	6	21	17	17	6	9

Major/Minor	Major1			Major2			Minor1			Minor2		
Conflicting Flow All	374	0	0	214	0	0	683	724	204	702	698	334
Stage 1	-	-	-	-	-	-	316	316	-	368	368	-
Stage 2	-	-	-	-	-	-	367	408	-	334	330	-
Critical Hdwy	4.11	-	-	4.12	-	-	7.1	6.5	6.2	7.16	6.56	6.26
Critical Hdwy Stg 1	-	-	-	-	-	-	6.1	5.5	-	6.16	5.56	-
Critical Hdwy Stg 2	-	-	-	-	-	-	6.1	5.5	-	6.16	5.56	-
Follow-up Hdwy	2.209	-	-	2.218	-	-	3.5	4	3.3	3.554	4.054	3.354
Pot Cap-1 Maneuver	1190	-	-	1356	-	-	366	354	842	348	359	699
Stage 1	-	-	-	-	-	-	699	659	-	644	614	-
Stage 2	-	-	-	-	-	-	657	600	-	671	639	-
Platoon blocked, %	-	-	-	-	-	-	-	-	-	-	-	-
Mov Cap-1 Maneuver	1181	-	-	1350	-	-	335	325	835	303	329	694
Mov Cap-2 Maneuver	-	-	-	-	-	-	335	325	-	303	329	-
Stage 1	-	-	-	-	-	-	657	619	-	603	599	-
Stage 2	-	-	-	-	-	-	632	586	-	597	600	-

Approach	EB			WB			NB			SB		
HCM Control Delay, s	1.8			0.3			14.3			15.7		
HCM LOS							B			C		

Minor Lane/Major Mvmt	NBLn1	EBL	EBT	EBR	WBL	WBT	WBR	SBLn1
Capacity (veh/h)	429	1181	-	-	1350	-	-	369
HCM Lane V/C Ratio	0.101	0.05	-	-	0.013	-	-	0.087
HCM Control Delay (s)	14.3	8.2	0	-	7.7	0	-	15.7
HCM Lane LOS	B	A	A	-	A	A	-	C
HCM 95th %tile Q(veh)	0.3	0.2	-	-	0	-	-	0.3

HCM 6th TWSC  
4: Ponce de Leon Blvd & Altara Ave

02/19/2020

Intersection												
Int Delay, s/veh	1.3											
Movement	EBL	EBT	EBR	WBL	WBT	WBR	NBL	NBT	NBR	SBL	SBT	SBR
Lane Configurations		↕			↕			↕			↕	
Traffic Vol, veh/h	21	0	33	1	0	4	44	434	1	3	521	136
Future Vol, veh/h	21	0	33	1	0	4	44	434	1	3	521	136
Conflicting Peds, #/hr	2	0	14	14	0	2	34	0	31	31	0	34
Sign Control	Stop	Stop	Stop	Stop	Stop	Stop	Free	Free	Free	Free	Free	Free
RT Channelized	-	-	None	-	-	None	-	-	None	-	-	None
Storage Length	-	-	-	-	-	-	-	-	-	-	-	-
Veh in Median Storage, #	-	0	-	-	0	-	-	0	-	-	0	-
Grade, %	-	0	-	-	0	-	-	0	-	-	0	-
Peak Hour Factor	95	95	95	95	95	95	95	95	95	95	95	95
Heavy Vehicles, %	2	2	2	0	0	0	2	2	2	2	2	2
Mvmt Flow	22	0	35	1	0	4	46	457	1	3	548	143

Major/Minor	Minor2		Minor1		Major1				Major2			
Conflicting Flow All	983	1241	394	875	1312	262	725	0	0	489	0	0
Stage 1	660	660	-	581	581	-	-	-	-	-	-	-
Stage 2	323	581	-	294	731	-	-	-	-	-	-	-
Critical Hdwy	7.54	6.54	6.94	7.5	6.5	6.9	4.14	-	-	4.14	-	-
Critical Hdwy Stg 1	6.54	5.54	-	6.5	5.5	-	-	-	-	-	-	-
Critical Hdwy Stg 2	6.54	5.54	-	6.5	5.5	-	-	-	-	-	-	-
Follow-up Hdwy	3.52	4.02	3.32	3.5	4	3.3	2.22	-	-	2.22	-	-
Pot Cap-1 Maneuver	203	174	605	247	160	743	874	-	-	1070	-	-
Stage 1	418	458	-	472	503	-	-	-	-	-	-	-
Stage 2	663	498	-	695	430	-	-	-	-	-	-	-
Platoon blocked, %								-	-		-	-
Mov Cap-1 Maneuver	183	151	578	209	139	720	846	-	-	1038	-	-
Mov Cap-2 Maneuver	183	151	-	209	139	-	-	-	-	-	-	-
Stage 1	375	441	-	425	452	-	-	-	-	-	-	-
Stage 2	610	448	-	641	414	-	-	-	-	-	-	-

Approach	EB		WB		NB		SB			
HCM Control Delay, s	19		12.5		1.1		0			
HCM LOS	C		B							

Minor Lane/Major Mvmt	NBL	NBT	NBR	EBLn1	WBLn1	SBL	SBT	SBR
Capacity (veh/h)	846	-	-	314	484	1038	-	-
HCM Lane V/C Ratio	0.055	-	-	0.181	0.011	0.003	-	-
HCM Control Delay (s)	9.5	0.3	-	19	12.5	8.5	0	-
HCM Lane LOS	A	A	-	C	B	A	A	-
HCM 95th %tile Q(veh)	0.2	-	-	0.7	0	0	-	-

## Roadway Segment LOS

---

## Arterial Level of Service

---

### Arterial Level of Service: NB Ponce de Leon Blvd

---

Cross Street	Arterial Class	Flow Speed	Running Time	Signal Delay	Travel Time (s)	Dist (mi)	Arterial Speed	Arterial LOS
San Lorenzo Ave	III	30	11.2	3.3	14.5	0.08	19.8	C
Bird Road	III	30	23.7	87.0	110.7	0.19	6.1	F
Total	III		34.9	90.3	125.2	0.27	7.7	F

---

### Arterial Level of Service: SB Ponce de Leon Blvd

---

Cross Street	Arterial Class	Flow Speed	Running Time	Signal Delay	Travel Time (s)	Dist (mi)	Arterial Speed	Arterial LOS
Bird Road	III	30	24.3	77.9	102.2	0.19	6.8	F
San Lorenzo Ave	III	30	23.7	7.3	31.0	0.19	21.7	C
Total	III		48.0	85.2	133.2	0.38	10.2	E

## Arterial Level of Service

---

### Arterial Level of Service: NB LeJeune Rd

---

Cross Street	Arterial Class	Flow Speed	Running Time	Signal Delay	Travel Time (s)	Dist (mi)	Arterial Speed	Arterial LOS
Altara Ave	II	35	19.9	7.0	26.9	0.16	21.3	D
Bird Road	II	40	13.3	77.3	90.6	0.12	4.6	F
Total	II		33.2	84.3	117.5	0.28	8.4	F

---

### Arterial Level of Service: SB LeJeune Rd

---

Cross Street	Arterial Class	Flow Speed	Running Time	Signal Delay	Travel Time (s)	Dist (mi)	Arterial Speed	Arterial LOS
Bird Road	II	40	22.0	81.8	103.8	0.19	6.6	F
Altara Ave	II	35	14.5	7.2	21.7	0.12	19.2	D
Total	II		36.5	89.0	125.5	0.31	8.8	F

## Arterial Level of Service

---

### Arterial Level of Service: EB Bird Road

---

Cross Street	Arterial Class	Flow Speed	Running Time	Signal Delay	Travel Time (s)	Dist (mi)	Arterial Speed	Arterial LOS
LeJeune Rd	III	35	16.6	44.8	61.4	0.13	7.6	F
Ponce de Leon Blvd	III	35	26.3	37.8	64.1	0.22	12.3	E
Total	III		42.9	82.6	125.5	0.35	10.0	E

---

### Arterial Level of Service: WB Bird Road

---

Cross Street	Arterial Class	Flow Speed	Running Time	Signal Delay	Travel Time (s)	Dist (mi)	Arterial Speed	Arterial LOS
Ponce de Leon Blvd	III	35	18.6	45.0	63.6	0.15	8.2	F
LeJeune Rd	III	35	26.3	37.9	64.2	0.22	12.3	E
Total	III		44.9	82.9	127.8	0.36	10.3	E

## Arterial Level of Service

---

### Arterial Level of Service: WB Altara Ave

---

Cross Street	Arterial Class	Flow Speed	Running Time	Signal Delay	Travel Time (s)	Dist (mi)	Arterial Speed	Arterial LOS
LeJeune Rd	III	30	27.9	0.0	27.9	0.22	28.3	B
Total	III		27.9	0.0	27.9	0.22	28.3	B

PM Peak Hour Future without Proposed Development  
Conditions

---



## Intersection LOS

---

HCM 6th TWSC  
1: Salzedo St & Bird Road

Intersection						
Int Delay, s/veh	1					
Movement	EBT	EBR	WBL	WBT	NBL	NBR
Lane Configurations	↑↑	↑		↑↑↑	↑	
Traffic Vol, veh/h	1192	50	0	1806	25	35
Future Vol, veh/h	1192	50	0	1806	25	35
Conflicting Peds, #/hr	0	12	0	0	0	0
Sign Control	Free	Free	Free	Free	Stop	Stop
RT Channelized	-	None	-	None	-	None
Storage Length	-	208	-	-	0	-
Veh in Median Storage, #	0	-	-	0	0	-
Grade, %	0	-	-	0	0	-
Peak Hour Factor	97	97	97	97	97	97
Heavy Vehicles, %	1	1	1	1	2	2
Mvmt Flow	1229	52	0	1862	26	36

Major/Minor	Major1	Major2	Minor1		
Conflicting Flow All	0	0	-	-	1986 627
Stage 1	-	-	-	-	1241 -
Stage 2	-	-	-	-	745 -
Critical Hdwy	-	-	-	-	6.29 6.94
Critical Hdwy Stg 1	-	-	-	-	5.84 -
Critical Hdwy Stg 2	-	-	-	-	6.04 -
Follow-up Hdwy	-	-	-	-	3.67 3.32
Pot Cap-1 Maneuver	-	-	0	-	71 426
Stage 1	-	-	0	-	231 -
Stage 2	-	-	0	-	401 -
Platoon blocked, %	-	-	-	-	
Mov Cap-1 Maneuver	-	-	-	-	70 421
Mov Cap-2 Maneuver	-	-	-	-	70 -
Stage 1	-	-	-	-	228 -
Stage 2	-	-	-	-	401 -

Approach	EB	WB	NB
HCM Control Delay, s	0	0	51.9
HCM LOS			F

Minor Lane/Major Mvmt	NBLn1	EBT	EBR	WBT
Capacity (veh/h)	136	-	-	-
HCM Lane V/C Ratio	0.455	-	-	-
HCM Control Delay (s)	51.9	-	-	-
HCM Lane LOS	F	-	-	-
HCM 95th %tile Q(veh)	2	-	-	-

HCM 6th TWSC  
2: Aurora St & Bird Road

Intersection						
Int Delay, s/veh	0.5					
Movement	EBT	EBR	WBL	WBT	NBL	NBR
Lane Configurations	↑↑	↑		↑↑		↑
Traffic Vol, veh/h	1192	30	0	1798	0	85
Future Vol, veh/h	1192	30	0	1798	0	85
Conflicting Peds, #/hr	0	10	0	0	0	0
Sign Control	Free	Free	Free	Free	Stop	Stop
RT Channelized	-	None	-	None	-	None
Storage Length	-	208	-	-	-	0
Veh in Median Storage, #	0	-	-	0	0	-
Grade, %	0	-	-	0	0	-
Peak Hour Factor	97	97	97	97	97	92
Heavy Vehicles, %	1	1	1	1	5	5
Mvmt Flow	1229	31	0	1854	0	92

Major/Minor	Major1	Major2	Minor1		
Conflicting Flow All	0	0	-	-	625
Stage 1	-	-	-	-	-
Stage 2	-	-	-	-	-
Critical Hdwy	-	-	-	-	7
Critical Hdwy Stg 1	-	-	-	-	-
Critical Hdwy Stg 2	-	-	-	-	-
Follow-up Hdwy	-	-	-	-	3.35
Pot Cap-1 Maneuver	-	-	0	-	420
Stage 1	-	-	0	-	-
Stage 2	-	-	0	-	-
Platoon blocked, %	-	-	-	-	-
Mov Cap-1 Maneuver	-	-	-	-	416
Mov Cap-2 Maneuver	-	-	-	-	-
Stage 1	-	-	-	-	-
Stage 2	-	-	-	-	-

Approach	EB	WB	NB
HCM Control Delay, s	0	0	16.1
HCM LOS			C

Minor Lane/Major Mvmt	NBLn1	EBT	EBR	WBT
Capacity (veh/h)	416	-	-	-
HCM Lane V/C Ratio	0.222	-	-	-
HCM Control Delay (s)	16.1	-	-	-
HCM Lane LOS	C	-	-	-
HCM 95th %tile Q(veh)	0.8	-	-	-

HCM 6th TWSC  
 3: Ponce de Leon Blvd & Altara Ave

Intersection												
Int Delay, s/veh	2.5											
Movement	EBL	EBT	EBR	WBL	WBT	WBR	NBL	NBT	NBR	SBL	SBT	SBR
Lane Configurations		↕			↕			↕			↕	
Traffic Vol, veh/h	46	0	62	1	0	3	44	446	2	2	510	141
Future Vol, veh/h	46	0	62	1	0	3	44	446	2	2	510	141
Conflicting Peds, #/hr	2	0	18	18	0	2	37	0	39	39	0	37
Sign Control	Stop	Stop	Stop	Stop	Stop	Stop	Free	Free	Free	Free	Free	Free
RT Channelized	-	-	None	-	-	None	-	-	None	-	-	None
Storage Length	-	-	-	-	-	-	-	-	-	-	-	-
Veh in Median Storage, #	-	0	-	-	0	-	-	0	-	-	0	-
Grade, %	-	0	-	-	0	-	-	0	-	-	0	-
Peak Hour Factor	95	95	95	95	95	95	95	95	95	95	95	95
Heavy Vehicles, %	1	1	1	0	0	0	2	2	2	2	2	2
Mvmt Flow	48	0	65	1	0	3	46	469	2	2	537	148

Major/Minor	Minor2		Minor1		Major1				Major2			
Conflicting Flow All	981	1254	398	892	1327	277	722	0	0	510	0	0
Stage 1	652	652	-	601	601	-	-	-	-	-	-	-
Stage 2	329	602	-	291	726	-	-	-	-	-	-	-
Critical Hdwy	7.52	6.52	6.92	7.5	6.5	6.9	4.14	-	-	4.14	-	-
Critical Hdwy Stg 1	6.52	5.52	-	6.5	5.5	-	-	-	-	-	-	-
Critical Hdwy Stg 2	6.52	5.52	-	6.5	5.5	-	-	-	-	-	-	-
Follow-up Hdwy	3.51	4.01	3.31	3.5	4	3.3	2.22	-	-	2.22	-	-
Pot Cap-1 Maneuver	205	172	604	240	157	726	876	-	-	1051	-	-
Stage 1	426	465	-	459	493	-	-	-	-	-	-	-
Stage 2	661	490	-	698	433	-	-	-	-	-	-	-
Platoon blocked, %								-	-		-	-
Mov Cap-1 Maneuver	185	148	573	189	135	698	845	-	-	1012	-	-
Mov Cap-2 Maneuver	185	148	-	189	135	-	-	-	-	-	-	-
Stage 1	380	447	-	409	440	-	-	-	-	-	-	-
Stage 2	608	437	-	606	417	-	-	-	-	-	-	-

Approach	EB		WB		NB				SB	
HCM Control Delay, s	23.8		13.7		1.1				0	
HCM LOS	C		B							

Minor Lane/Major Mvmt	NBL	NBT	NBR	EBLn1	WBLn1	SBL	SBT	SBR
Capacity (veh/h)	845	-	-	303	417	1012	-	-
HCM Lane V/C Ratio	0.055	-	-	0.375	0.01	0.002	-	-
HCM Control Delay (s)	9.5	0.3	-	23.8	13.7	8.6	0	-
HCM Lane LOS	A	A	-	C	B	A	A	-
HCM 95th %tile Q(veh)	0.2	-	-	1.7	0	0	-	-

HCM 6th TWSC  
4: Aurora St & Altara Ave

Intersection												
Int Delay, s/veh	5.8											
Movement	EBL	EBT	EBR	WBL	WBT	WBR	NBL	NBT	NBR	SBL	SBT	SBR
Lane Configurations		↕			↕			↕			↕	
Traffic Vol, veh/h	22	38	42	14	92	37	22	22	23	45	16	84
Future Vol, veh/h	22	38	42	14	92	37	22	22	23	45	16	84
Conflicting Peds, #/hr	6	0	23	23	0	6	8	0	30	30	0	8
Sign Control	Free	Free	Free	Free	Free	Free	Stop	Stop	Stop	Stop	Stop	Stop
RT Channelized	-	-	None	-	-	None	-	-	None	-	-	None
Storage Length	-	-	-	-	-	-	-	-	-	-	-	-
Veh in Median Storage, #	-	0	-	-	0	-	-	0	-	-	0	-
Grade, %	-	0	-	-	0	-	-	0	-	-	0	-
Peak Hour Factor	93	93	93	93	93	93	93	93	93	93	93	93
Heavy Vehicles, %	0	0	0	1	1	1	0	0	0	1	1	1
Mvmt Flow	24	41	45	15	99	40	24	24	25	48	17	90

Major/Minor	Major1			Major2			Minor1			Minor2		
Conflicting Flow All	145	0	0	109	0	0	346	310	117	321	312	133
Stage 1	-	-	-	-	-	-	135	135	-	155	155	-
Stage 2	-	-	-	-	-	-	211	175	-	166	157	-
Critical Hdwy	4.1	-	-	4.11	-	-	7.1	6.5	6.2	7.11	6.51	6.21
Critical Hdwy Stg 1	-	-	-	-	-	-	6.1	5.5	-	6.11	5.51	-
Critical Hdwy Stg 2	-	-	-	-	-	-	6.1	5.5	-	6.11	5.51	-
Follow-up Hdwy	2.2	-	-	2.209	-	-	3.5	4	3.3	3.509	4.009	3.309
Pot Cap-1 Maneuver	1450	-	-	1488	-	-	612	608	941	634	605	919
Stage 1	-	-	-	-	-	-	873	789	-	850	771	-
Stage 2	-	-	-	-	-	-	796	758	-	838	770	-
Platoon blocked, %	-	-	-	-	-	-	-	-	-	-	-	-
Mov Cap-1 Maneuver	1442	-	-	1455	-	-	511	574	894	564	571	907
Mov Cap-2 Maneuver	-	-	-	-	-	-	511	574	-	564	571	-
Stage 1	-	-	-	-	-	-	838	757	-	830	758	-
Stage 2	-	-	-	-	-	-	687	745	-	753	739	-

Approach	EB			WB			NB			SB		
HCM Control Delay, s	1.6			0.7			11.5			11.3		
HCM LOS							B			B		

Minor Lane/Major Mvmt	NBLn1	EBL	EBT	EBR	WBL	WBT	WBR	SBLn1
Capacity (veh/h)	626	1442	-	-	1455	-	-	723
HCM Lane V/C Ratio	0.115	0.016	-	-	0.01	-	-	0.216
HCM Control Delay (s)	11.5	7.5	0	-	7.5	0	-	11.3
HCM Lane LOS	B	A	A	-	A	A	-	B
HCM 95th %tile Q(veh)	0.4	0.1	-	-	0	-	-	0.8

HCM 6th Signalized Intersection Summary  
 2594: Ponce de Leon Blvd & Bird Road

02/19/2020



Movement	EBL	EBT	EBR	WBL	WBT	WBR	NBL	NBT	NBR	SBL	SBT	SBR
Lane Configurations	↖	↗	↘	↖	↗		↖	↗		↖	↗	↘
Traffic Volume (veh/h)	150	1059	79	137	1573	121	102	332	67	124	439	148
Future Volume (veh/h)	150	1059	79	137	1573	121	102	332	67	124	439	148
Initial Q (Qb), veh	0	0	0	0	0	0	0	0	0	0	0	0
Ped-Bike Adj(A_pbT)	1.00		1.00	1.00		1.00	1.00		1.00	1.00		1.00
Parking Bus, Adj	1.00	1.00	1.00	1.00	1.00	1.00	1.00	1.00	1.00	1.00	1.00	1.00
Work Zone On Approach		No			No			No			No	
Adj Sat Flow, veh/h/ln	1697	1697	1697	1697	1697	1697	1683	1683	1683	1683	1683	1683
Adj Flow Rate, veh/h	155	1092	81	141	1622	125	105	342	69	128	453	153
Peak Hour Factor	0.97	0.97	0.97	0.97	0.97	0.97	0.97	0.97	0.97	0.97	0.97	0.97
Percent Heavy Veh, %	1	1	1	1	1	1	2	2	2	2	2	2
Cap, veh/h	136	1962	925	376	1886	144	115	380	76	144	528	281
Arrive On Green	0.06	1.00	1.00	0.04	0.62	0.62	0.03	0.14	0.14	0.06	0.17	0.17
Sat Flow, veh/h	1616	3224	1438	1616	3035	232	1603	2657	530	1603	3198	1427
Grp Volume(v), veh/h	155	1092	81	141	855	892	105	204	207	128	453	153
Grp Sat Flow(s),veh/h/ln	1616	1612	1438	1616	1612	1655	1603	1599	1588	1603	1599	1427
Q Serve(g_s), s	5.7	0.0	0.0	6.0	77.0	79.6	6.2	22.6	23.1	10.2	24.8	17.4
Cycle Q Clear(g_c), s	5.7	0.0	0.0	6.0	77.0	79.6	6.2	22.6	23.1	10.2	24.8	17.4
Prop In Lane	1.00		1.00	1.00		0.14	1.00		0.33	1.00		1.00
Lane Grp Cap(c), veh/h	136	1962	925	376	1002	1029	115	228	227	144	528	281
V/C Ratio(X)	1.14	0.56	0.09	0.37	0.85	0.87	0.91	0.89	0.91	0.89	0.86	0.55
Avail Cap(c_a), veh/h	136	1962	925	418	1002	1029	115	283	281	144	638	330
HCM Platoon Ratio	2.00	2.00	2.00	1.00	1.00	1.00	1.00	1.00	1.00	1.00	1.00	1.00
Upstream Filter(I)	1.00	1.00	1.00	1.00	1.00	1.00	1.00	1.00	1.00	1.00	1.00	1.00
Uniform Delay (d), s/veh	43.1	0.0	0.0	11.9	27.5	28.0	74.4	75.8	76.0	68.0	73.1	65.0
Incr Delay (d2), s/veh	119.6	1.1	0.2	0.2	9.2	9.8	55.9	23.6	27.0	43.5	9.2	1.2
Initial Q Delay(d3),s/veh	0.0	0.0	0.0	0.0	0.0	0.0	0.0	0.0	0.0	0.0	0.0	0.0
%ile BackOfQ(50%),veh/ln	8.3	0.3	0.0	2.2	31.4	33.4	4.0	10.9	11.2	3.2	10.9	6.5
Unsig. Movement Delay, s/veh												
LnGrp Delay(d),s/veh	162.8	1.1	0.2	12.1	36.6	37.8	130.3	99.4	103.0	111.5	82.3	66.3
LnGrp LOS	F	A	A	B	D	D	F	F	F	F	F	E
Approach Vol, veh/h		1328			1888			516			734	
Approach Delay, s/veh		19.9			35.3			107.1			84.1	
Approach LOS		B			D			F			F	
Timer - Assigned Phs	1	2	3	4	5	6	7	8				
Phs Duration (G+Y+Rc), s	14.3	115.9	13.0	36.8	12.0	118.2	17.0	32.8				
Change Period (Y+Rc), s	* 6.3	* 6.3	* 6.8	7.1	* 6.3	* 6.3	* 6.8	7.1				
Max Green Setting (Gmax), s	* 13	* 99	* 6.2	35.9	* 5.7	* 1.1E2	* 10	31.9				
Max Q Clear Time (g_c+I1), s	8.0	0.0	8.2	26.8	7.7	0.0	12.2	25.1				
Green Ext Time (p_c), s	0.1	0.0	0.0	1.3	0.0	0.0	0.0	0.6				

Intersection Summary



























HCM 6th Ctrl Delay	47.1
HCM 6th LOS	D

Notes

\* HCM 6th computational engine requires equal clearance times for the phases crossing the barrier.

HCM 6th Signalized Intersection Summary  
 2595: LeJeune Rd & Bird Road

02/19/2020

												
Movement	EBL	EBT	EBR	WBL	WBT	WBR	NBL	NBT	NBR	SBL	SBT	SBR
Lane Configurations		 			  			 			 	
Traffic Volume (veh/h)	110	1040	170	139	1474	186	153	779	78	150	878	71
Future Volume (veh/h)	110	1040	170	139	1474	186	153	779	78	150	878	71
Initial Q (Qb), veh	0	0	0	0	0	0	0	0	0	0	0	0
Ped-Bike Adj(A_pbT)	1.00		1.00	1.00		1.00	1.00		1.00	1.00		1.00
Parking Bus, Adj	1.00	1.00	1.00	1.00	1.00	1.00	1.00	1.00	1.00	1.00	1.00	1.00
Work Zone On Approach		No			No			No			No	
Adj Sat Flow, veh/h/ln	1885	1885	1885	1885	1885	1885	1870	1870	1870	1885	1885	1885
Adj Flow Rate, veh/h	116	1095	179	146	1552	196	161	820	82	158	924	75
Peak Hour Factor	0.95	0.95	0.95	0.95	0.95	0.95	0.95	0.95	0.95	0.95	0.95	0.95
Percent Heavy Veh, %	1	1	1	1	1	1	2	2	2	1	1	1
Cap, veh/h	222	1708	762	245	2327	293	113	953	95	139	980	80
Arrive On Green	0.03	0.48	0.48	0.11	1.00	1.00	0.05	0.39	0.39	0.03	0.29	0.29
Sat Flow, veh/h	1795	3582	1598	1795	4628	583	1781	3262	326	1795	3355	272
Grp Volume(v), veh/h	116	1095	179	146	1150	598	161	447	455	158	493	506
Grp Sat Flow(s),veh/h/ln	1795	1791	1598	1795	1716	1780	1781	1777	1812	1795	1791	1836
Q Serve(g_s), s	5.0	41.5	11.9	7.7	0.0	0.0	6.1	41.6	41.6	6.1	48.4	48.4
Cycle Q Clear(g_c), s	5.0	41.5	11.9	7.7	0.0	0.0	6.1	41.6	41.6	6.1	48.4	48.4
Prop In Lane	1.00		1.00	1.00		0.33	1.00		0.18	1.00		0.15
Lane Grp Cap(c), veh/h	222	1708	762	245	1725	895	113	519	529	139	523	536
V/C Ratio(X)	0.52	0.64	0.23	0.60	0.67	0.67	1.42	0.86	0.86	1.14	0.94	0.94
Avail Cap(c_a), veh/h	222	1708	762	268	1725	895	113	583	595	139	588	603
HCM Platoon Ratio	1.00	1.00	1.00	2.00	2.00	2.00	1.33	1.33	1.33	1.00	1.00	1.00
Upstream Filter(l)	1.00	1.00	1.00	1.00	1.00	1.00	0.92	0.92	0.92	1.00	1.00	1.00
Uniform Delay (d), s/veh	24.1	35.5	27.7	26.9	0.0	0.0	59.7	51.7	51.7	64.1	62.2	62.2
Incr Delay (d2), s/veh	2.6	1.9	0.7	1.8	2.1	3.9	229.8	10.4	10.3	117.9	22.4	22.0
Initial Q Delay(d3),s/veh	0.0	0.0	0.0	0.0	0.0	0.0	0.0	0.0	0.0	0.0	0.0	0.0
%ile BackOfQ(50%),veh/ln	3.0	18.6	4.8	3.1	0.5	1.0	9.5	19.0	19.4	8.0	25.1	25.7
Unsig. Movement Delay, s/veh												
LnGrp Delay(d),s/veh	26.7	37.3	28.5	28.6	2.1	3.9	289.5	62.1	61.9	182.0	84.6	84.2
LnGrp LOS	C	D	C	C	A	A	F	E	E	F	F	F
Approach Vol, veh/h		1390			1894			1063			1157	
Approach Delay, s/veh		35.3			4.7			96.5			97.8	
Approach LOS		D			A			F			F	
Timer - Assigned Phs	1	2	3	4	5	6	7	8				
Phs Duration (G+Y+Rc), s	15.7	91.8	13.0	59.5	11.0	96.5	13.0	59.5				
Change Period (Y+Rc), s	6.0	6.0	6.9	6.9	6.0	6.0	6.9	6.9				
Max Green Setting (Gmax), s	12.0	77.0	6.1	59.1	5.0	84.0	6.1	59.1				
Max Q Clear Time (g_c+I1), s	9.7	0.0	8.1	50.4	7.0	0.0	8.1	43.6				
Green Ext Time (p_c), s	0.0	0.0	0.0	2.1	0.0	0.0	0.0	2.4				
<b>Intersection Summary</b>												
HCM 6th Ctrl Delay			49.7									
HCM 6th LOS			D									

HCM 6th Signalized Intersection Summary  
 3272: LeJeune Rd & Altara Ave

02/19/2020



Movement	EBL	EBT	EBR	WBL	WBT	WBR	NBL	NBT	NBR	SBL	SBT	SBR
Lane Configurations		↕			↕		↗	↕		↗	↕	
Traffic Volume (veh/h)	0	0	0	137	0	155	0	857	109	118	1052	0
Future Volume (veh/h)	0	0	0	137	0	155	0	857	109	118	1052	0
Initial Q (Qb), veh	0	0	0	0	0	0	0	0	0	0	0	0
Ped-Bike Adj(A_pbT)	1.00		1.00	1.00		1.00	1.00		1.00	1.00		1.00
Parking Bus, Adj	1.00	1.00	1.00	1.00	1.00	1.00	1.00	1.00	1.00	1.00	1.00	1.00
Work Zone On Approach		No			No			No			No	
Adj Sat Flow, veh/h/ln	1870	1870	1870	1885	1885	1885	1885	1885	1885	1885	1885	0
Adj Flow Rate, veh/h	0	0	0	144	0	163	0	902	115	124	1107	0
Peak Hour Factor	0.95	0.95	0.95	0.95	0.95	0.95	0.95	0.95	0.95	0.95	0.95	0.95
Percent Heavy Veh, %	2	2	2	1	1	1	1	1	1	1	1	0
Cap, veh/h	0	401	0	182	0	172	40	2292	292	379	2569	0
Arrive On Green	0.00	0.00	0.00	0.21	0.00	0.21	0.00	0.72	0.72	1.00	1.00	0.00
Sat Flow, veh/h	0	1870	0	710	0	804	513	3195	407	559	3676	0
Grp Volume(v), veh/h	0	0	0	307	0	0	0	506	511	124	1107	0
Grp Sat Flow(s),veh/h/ln	0	1870	0	1514	0	0	513	1791	1812	559	1791	0
Q Serve(g_s), s	0.0	0.0	0.0	36.0	0.0	0.0	0.0	20.0	20.0	9.0	0.0	0.0
Cycle Q Clear(g_c), s	0.0	0.0	0.0	36.0	0.0	0.0	0.0	20.0	20.0	29.0	0.0	0.0
Prop In Lane	0.00		0.00	0.47		0.53	1.00		0.22	1.00		0.00
Lane Grp Cap(c), veh/h	0	401	0	354	0	0	40	1285	1300	379	2569	0
V/C Ratio(X)	0.00	0.00	0.00	0.87	0.00	0.00	0.00	0.39	0.39	0.33	0.43	0.00
Avail Cap(c_a), veh/h	0	464	0	405	0	0	40	1285	1300	379	2569	0
HCM Platoon Ratio	1.00	1.00	1.00	1.00	1.00	1.00	1.00	1.00	1.00	2.00	2.00	1.00
Upstream Filter(l)	0.00	0.00	0.00	1.00	0.00	0.00	0.00	1.00	1.00	0.50	0.50	0.00
Uniform Delay (d), s/veh	0.0	0.0	0.0	69.7	0.0	0.0	0.0	10.0	10.0	2.2	0.0	0.0
Incr Delay (d2), s/veh	0.0	0.0	0.0	16.2	0.0	0.0	0.0	0.9	0.9	1.2	0.3	0.0
Initial Q Delay(d3),s/veh	0.0	0.0	0.0	0.0	0.0	0.0	0.0	0.0	0.0	0.0	0.0	0.0
%ile BackOfQ(50%),veh/ln	0.0	0.0	0.0	15.6	0.0	0.0	0.0	8.1	8.2	0.7	0.1	0.0
Unsig. Movement Delay, s/veh												
LnGrp Delay(d),s/veh	0.0	0.0	0.0	85.9	0.0	0.0	0.0	10.9	10.9	3.4	0.3	0.0
LnGrp LOS	A	A	A	F	A	A	A	B	B	A	A	A
Approach Vol, veh/h		0			307			1017			1231	
Approach Delay, s/veh		0.0			85.9			10.9			0.6	
Approach LOS					F			B			A	
Timer - Assigned Phs		2		4		6		8				
Phs Duration (G+Y+Rc), s		135.1		44.9		135.1		44.9				
Change Period (Y+Rc), s		6.0		* 6.3		6.0		* 6.3				
Max Green Setting (Gmax), s		123.0		* 45		123.0		* 45				
Max Q Clear Time (g_c+I1), s		0.0		0.0		0.0		38.0				
Green Ext Time (p_c), s		0.0		0.0		0.0		0.6				

Intersection Summary

HCM 6th Ctrl Delay	15.0
HCM 6th LOS	B

Notes

\* HCM 6th computational engine requires equal clearance times for the phases crossing the barrier.



HCM 6th Signalized Intersection Summary  
6165: Ponce de Leon Blvd & San Lorenzo Ave

02/19/2020



Movement	EBL	EBR	NBL	NBT	SBT	SBR
Lane Configurations						
Traffic Volume (veh/h)	25	46	63	444	474	77
Future Volume (veh/h)	25	46	63	444	474	77
Initial Q (Qb), veh	0	0	0	0	0	0
Ped-Bike Adj(A_pbT)	1.00	1.00	1.00			1.00
Parking Bus, Adj	1.00	1.00	1.00	1.00	1.00	1.00
Work Zone On Approach	No			No	No	
Adj Sat Flow, veh/h/ln	1900	1900	1870	1870	1870	1870
Adj Flow Rate, veh/h	26	47	65	458	489	79
Peak Hour Factor	0.97	0.97	0.97	0.97	0.97	0.97
Percent Heavy Veh, %	0	0	2	2	2	2
Cap, veh/h	42	75	659	2730	1967	316
Arrive On Green	0.07	0.07	0.05	0.77	0.64	0.64
Sat Flow, veh/h	590	1066	1781	3647	3159	493
Grp Volume(v), veh/h	74	0	65	458	282	286
Grp Sat Flow(s),veh/h/ln	1679	0	1781	1777	1777	1782
Q Serve(g_s), s	3.4	0.0	0.9	2.7	5.4	5.5
Cycle Q Clear(g_c), s	3.4	0.0	0.9	2.7	5.4	5.5
Prop In Lane	0.35	0.64	1.00			0.28
Lane Grp Cap(c), veh/h	119	0	659	2730	1140	1143
V/C Ratio(X)	0.62	0.00	0.10	0.17	0.25	0.25
Avail Cap(c_a), veh/h	371	0	700	2730	1140	1143
HCM Platoon Ratio	1.00	1.00	1.00	1.00	1.00	1.00
Upstream Filter(l)	1.00	0.00	1.00	1.00	1.00	1.00
Uniform Delay (d), s/veh	36.1	0.0	3.8	2.5	6.1	6.1
Incr Delay (d2), s/veh	4.0	0.0	0.0	0.1	0.5	0.5
Initial Q Delay(d3),s/veh	0.0	0.0	0.0	0.0	0.0	0.0
%ile BackOfQ(50%),veh/ln	1.5	0.0	0.2	0.6	1.9	1.9
Unsig. Movement Delay, s/veh						
LnGrp Delay(d),s/veh	40.1	0.0	3.8	2.6	6.6	6.6
LnGrp LOS	D	A	A	A	A	A
Approach Vol, veh/h	74			523	568	
Approach Delay, s/veh	40.1			2.7	6.6	
Approach LOS	D			A	A	
Timer - Assigned Phs		2		4	5	6
Phs Duration (G+Y+Rc), s		68.1		11.9	10.1	57.9
Change Period (Y+Rc), s		6.6		* 6.3	* 6.3	6.6
Max Green Setting (Gmax), s		49.4		* 18	* 5.7	37.4
Max Q Clear Time (g_c+I1), s		0.0		5.4	2.9	0.0
Green Ext Time (p_c), s		0.0		0.1	0.0	0.0
<b>Intersection Summary</b>						
HCM 6th Ctrl Delay			7.0			
HCM 6th LOS			A			

Notes

\* HCM 6th computational engine requires equal clearance times for the phases crossing the barrier.

## Roadway Segment LOS

---

## Arterial Level of Service

---

### Arterial Level of Service: NB Ponce de Leon Blvd

---

Cross Street	Arterial Class	Flow Speed	Running Time	Signal Delay	Travel Time (s)	Dist (mi)	Arterial Speed	Arterial LOS
San Lorenzo Ave	III	30	11.2	3.8	15.0	0.08	19.1	C
Bird Road	III	30	23.7	89.1	112.8	0.19	6.0	F
Total	III		34.9	92.9	127.8	0.27	7.5	F

---

### Arterial Level of Service: SB Ponce de Leon Blvd

---

Cross Street	Arterial Class	Flow Speed	Running Time	Signal Delay	Travel Time (s)	Dist (mi)	Arterial Speed	Arterial LOS
Bird Road	III	30	24.3	83.6	107.9	0.19	6.4	F
San Lorenzo Ave	III	30	23.7	8.3	32.0	0.19	21.0	C
Total	III		48.0	91.9	139.9	0.38	9.7	F

## Arterial Level of Service

---

### Arterial Level of Service: NB LeJeune Rd

---

Cross Street	Arterial Class	Flow Speed	Running Time	Signal Delay	Travel Time (s)	Dist (mi)	Arterial Speed	Arterial LOS
Altara Ave	II	35	19.9	11.0	30.9	0.16	18.6	D
Bird Road	II	40	13.3	58.8	72.1	0.12	5.8	F
Total	II		33.2	69.8	103.0	0.28	9.6	F

---

### Arterial Level of Service: SB LeJeune Rd

---

Cross Street	Arterial Class	Flow Speed	Running Time	Signal Delay	Travel Time (s)	Dist (mi)	Arterial Speed	Arterial LOS
Bird Road	II	40	22.0	73.4	95.4	0.19	7.2	F
	II	35	14.5	3.0	17.5	0.12	23.8	C
Total	II		36.5	76.4	112.9	0.31	9.8	F

## Arterial Level of Service

---

### Arterial Level of Service: EB Bird Road

---

Cross Street	Arterial Class	Flow Speed	Running Time	Signal Delay	Travel Time (s)	Dist (mi)	Arterial Speed	Arterial LOS
LeJeune Rd	III	35	16.6	41.3	57.9	0.13	8.1	F
Ponce de Leon Blvd	III	35	26.3	7.8	34.1	0.22	23.1	C
Total	III		42.9	49.1	92.0	0.35	13.6	E

---

### Arterial Level of Service: WB Bird Road

---

Cross Street	Arterial Class	Flow Speed	Running Time	Signal Delay	Travel Time (s)	Dist (mi)	Arterial Speed	Arterial LOS
Ponce de Leon Blvd	III	35	18.6	44.2	62.8	0.15	8.3	F
LeJeune Rd	III	35	26.3	43.3	69.6	0.22	11.3	E
Total	III		44.9	87.5	132.4	0.36	9.9	F

## Arterial Level of Service

---

### Arterial Level of Service: WB Altara Ave

---

Cross Street	Arterial Class	Flow Speed	Running Time	Signal Delay	Travel Time (s)	Dist (mi)	Arterial Speed	Arterial LOS
LeJeune Rd	III	30	27.9	0.0	27.9	0.22	28.3	B
Total	III		27.9	0.0	27.9	0.22	28.3	B

## AM Peak Hour Future with Proposed Development Conditions

---

## Intersection LOS

---



HCM 6th TWSC  
 1: Salzedo St & Bird Road

Intersection						
Int Delay, s/veh	0.5					
Movement	EBT	EBR	WBL	WBT	NBL	NBR
Lane Configurations	↑↑	↑		↑↑↑	↑	
Traffic Vol, veh/h	1557	21	0	1247	12	22
Future Vol, veh/h	1557	21	0	1247	12	22
Conflicting Peds, #/hr	0	5	0	0	0	0
Sign Control	Free	Free	Free	Free	Stop	Stop
RT Channelized	-	None	-	None	-	None
Storage Length	-	208	-	-	0	-
Veh in Median Storage, #	0	-	-	0	0	-
Grade, %	0	-	-	0	0	-
Peak Hour Factor	97	97	97	97	97	97
Heavy Vehicles, %	2	2	0	3	0	0
Mvmt Flow	1605	22	0	1286	12	23

Major/Minor	Major1	Major2	Minor1		
Conflicting Flow All	0	0	-	-	2124 808
Stage 1	-	-	-	-	1610 -
Stage 2	-	-	-	-	514 -
Critical Hdwy	-	-	-	-	6.25 6.9
Critical Hdwy Stg 1	-	-	-	-	5.8 -
Critical Hdwy Stg 2	-	-	-	-	6 -
Follow-up Hdwy	-	-	-	-	3.65 3.3
Pot Cap-1 Maneuver	-	-	0	-	60 328
Stage 1	-	-	0	-	150 -
Stage 2	-	-	0	-	537 -
Platoon blocked, %	-	-	-	-	
Mov Cap-1 Maneuver	-	-	-	-	60 326
Mov Cap-2 Maneuver	-	-	-	-	60 -
Stage 1	-	-	-	-	149 -
Stage 2	-	-	-	-	537 -

Approach	EB	WB	NB
HCM Control Delay, s	0	0	43.8
HCM LOS			E

Minor Lane/Major Mvmt	NBLn1	EBT	EBR	WBT
Capacity (veh/h)	127	-	-	-
HCM Lane V/C Ratio	0.276	-	-	-
HCM Control Delay (s)	43.8	-	-	-
HCM Lane LOS	E	-	-	-
HCM 95th %tile Q(veh)	1	-	-	-

HCM 6th TWSC  
 2: Aurora St & Bird Road

Intersection						
Int Delay, s/veh	0.4					
Movement	EBT	EBR	WBL	WBT	NBL	NBR
Lane Configurations	↑↑	↑		↑↑		↑
Traffic Vol, veh/h	1524	72	0	1215	0	59
Future Vol, veh/h	1524	72	0	1215	0	59
Conflicting Peds, #/hr	0	7	0	0	0	0
Sign Control	Free	Free	Free	Free	Stop	Stop
RT Channelized	-	None	-	None	-	None
Storage Length	-	208	-	-	-	0
Veh in Median Storage, #	0	-	-	0	0	-
Grade, %	0	-	-	0	0	-
Peak Hour Factor	96	96	96	96	96	96
Heavy Vehicles, %	2	2	0	3	0	3
Mvmt Flow	1588	75	0	1266	0	61

Major/Minor	Major1	Major2	Minor1		
Conflicting Flow All	0	0	-	-	801
Stage 1	-	-	-	-	-
Stage 2	-	-	-	-	-
Critical Hdwy	-	-	-	-	6.96
Critical Hdwy Stg 1	-	-	-	-	-
Critical Hdwy Stg 2	-	-	-	-	-
Follow-up Hdwy	-	-	-	-	3.33
Pot Cap-1 Maneuver	-	-	0	-	325
Stage 1	-	-	0	-	-
Stage 2	-	-	0	-	-
Platoon blocked, %	-	-	-	-	-
Mov Cap-1 Maneuver	-	-	-	-	323
Mov Cap-2 Maneuver	-	-	-	-	-
Stage 1	-	-	-	-	-
Stage 2	-	-	-	-	-

Approach	EB	WB	NB
HCM Control Delay, s	0	0	18.7
HCM LOS			C

Minor Lane/Major Mvmt	NBLn1	EBT	EBR	WBT
Capacity (veh/h)	323	-	-	-
HCM Lane V/C Ratio	0.19	-	-	-
HCM Control Delay (s)	18.7	-	-	-
HCM Lane LOS	C	-	-	-
HCM 95th %tile Q(veh)	0.7	-	-	-

HCM 6th TWSC  
3: Aurora St & Altara Ave

Intersection												
Int Delay, s/veh	3.6											
Movement	EBL	EBT	EBR	WBL	WBT	WBR	NBL	NBT	NBR	SBL	SBT	SBR
Lane Configurations		↕			↕			↕			↕	
Traffic Vol, veh/h	49	96	15	9	151	70	3	11	9	13	3	38
Future Vol, veh/h	49	96	15	9	151	70	3	11	9	13	3	38
Conflicting Peds, #/hr	8	0	5	5	0	8	0	0	4	4	0	0
Sign Control	Free	Free	Free	Free	Free	Free	Stop	Stop	Stop	Stop	Stop	Stop
RT Channelized	-	-	None	-	-	None	-	-	None	-	-	None
Storage Length	-	-	-	-	-	-	-	-	-	-	-	-
Veh in Median Storage, #	-	0	-	-	0	-	-	0	-	-	0	-
Grade, %	-	0	-	-	0	-	-	0	-	-	0	-
Peak Hour Factor	53	53	53	53	53	53	53	53	53	53	53	53
Heavy Vehicles, %	1	1	1	2	2	2	0	0	0	6	6	6
Mvmt Flow	92	181	28	17	285	132	6	21	17	25	6	72

Major/Minor	Major1			Major2			Minor1			Minor2		
Conflicting Flow All	425	0	0	214	0	0	808	843	204	795	791	359
Stage 1	-	-	-	-	-	-	384	384	-	393	393	-
Stage 2	-	-	-	-	-	-	424	459	-	402	398	-
Critical Hdwy	4.11	-	-	4.12	-	-	7.1	6.5	6.2	7.16	6.56	6.26
Critical Hdwy Stg 1	-	-	-	-	-	-	6.1	5.5	-	6.16	5.56	-
Critical Hdwy Stg 2	-	-	-	-	-	-	6.1	5.5	-	6.16	5.56	-
Follow-up Hdwy	2.209	-	-	2.218	-	-	3.5	4	3.3	3.554	4.054	3.354
Pot Cap-1 Maneuver	1140	-	-	1356	-	-	302	303	842	301	317	676
Stage 1	-	-	-	-	-	-	643	615	-	624	599	-
Stage 2	-	-	-	-	-	-	612	570	-	617	596	-
Platoon blocked, %	-	-	-	-	-	-	-	-	-	-	-	-
Mov Cap-1 Maneuver	1131	-	-	1350	-	-	243	267	835	252	279	671
Mov Cap-2 Maneuver	-	-	-	-	-	-	243	267	-	252	279	-
Stage 1	-	-	-	-	-	-	581	555	-	562	584	-
Stage 2	-	-	-	-	-	-	532	556	-	526	538	-

Approach	EB			WB			NB			SB		
HCM Control Delay, s	2.6			0.3			16.4			15.2		
HCM LOS							C			C		

Minor Lane/Major Mvmt	NBLn1	EBL	EBT	EBR	WBL	WBT	WBR	SBLn1
Capacity (veh/h)	358	1131	-	-	1350	-	-	454
HCM Lane V/C Ratio	0.121	0.082	-	-	0.013	-	-	0.224
HCM Control Delay (s)	16.4	8.5	0	-	7.7	0	-	15.2
HCM Lane LOS	C	A	A	-	A	A	-	C
HCM 95th %tile Q(veh)	0.4	0.3	-	-	0	-	-	0.9

HCM 6th TWSC  
 4: Ponce de Leon Blvd & Altara Ave

Intersection												
Int Delay, s/veh	1.4											
Movement	EBL	EBT	EBR	WBL	WBT	WBR	NBL	NBT	NBR	SBL	SBT	SBR
Lane Configurations		↕			↕			↕			↕	
Traffic Vol, veh/h	21	0	37	1	0	4	48	434	1	3	521	159
Future Vol, veh/h	21	0	37	1	0	4	48	434	1	3	521	159
Conflicting Peds, #/hr	2	0	14	14	0	2	34	0	31	31	0	34
Sign Control	Stop	Stop	Stop	Stop	Stop	Stop	Free	Free	Free	Free	Free	Free
RT Channelized	-	-	None	-	-	None	-	-	None	-	-	None
Storage Length	-	-	-	-	-	-	-	-	-	-	-	-
Veh in Median Storage, #	-	0	-	-	0	-	-	0	-	-	0	-
Grade, %	-	0	-	-	0	-	-	0	-	-	0	-
Peak Hour Factor	95	95	95	95	95	95	95	95	95	95	95	95
Heavy Vehicles, %	2	2	2	0	0	0	2	2	2	2	2	2
Mvmt Flow	22	0	39	1	0	4	51	457	1	3	548	167

Major/Minor	Minor2		Minor1		Major1				Major2			
Conflicting Flow All	1005	1263	406	885	1346	262	749	0	0	489	0	0
Stage 1	672	672	-	591	591	-	-	-	-	-	-	-
Stage 2	333	591	-	294	755	-	-	-	-	-	-	-
Critical Hdwy	7.54	6.54	6.94	7.5	6.5	6.9	4.14	-	-	4.14	-	-
Critical Hdwy Stg 1	6.54	5.54	-	6.5	5.5	-	-	-	-	-	-	-
Critical Hdwy Stg 2	6.54	5.54	-	6.5	5.5	-	-	-	-	-	-	-
Follow-up Hdwy	3.52	4.02	3.32	3.5	4	3.3	2.22	-	-	2.22	-	-
Pot Cap-1 Maneuver	196	168	594	243	153	743	856	-	-	1070	-	-
Stage 1	412	453	-	465	498	-	-	-	-	-	-	-
Stage 2	654	493	-	695	420	-	-	-	-	-	-	-
Platoon blocked, %								-	-		-	-
Mov Cap-1 Maneuver	176	144	567	202	131	720	828	-	-	1038	-	-
Mov Cap-2 Maneuver	176	144	-	202	131	-	-	-	-	-	-	-
Stage 1	365	436	-	414	443	-	-	-	-	-	-	-
Stage 2	595	438	-	635	404	-	-	-	-	-	-	-

Approach	EB		WB		NB				SB		
HCM Control Delay, s	19.2		12.6		1.2				0		
HCM LOS	C		B								

Minor Lane/Major Mvmt	NBL	NBT	NBR	EBLn1	WBLn1	SBL	SBT	SBR
Capacity (veh/h)	828	-	-	314	476	1038	-	-
HCM Lane V/C Ratio	0.061	-	-	0.194	0.011	0.003	-	-
HCM Control Delay (s)	9.6	0.3	-	19.2	12.6	8.5	0	-
HCM Lane LOS	A	A	-	C	B	A	A	-
HCM 95th %tile Q(veh)	0.2	-	-	0.7	0	0	-	-

HCM 6th TWSC  
 5: Aurora St & 250 Bird Road























Intersection						
Int Delay, s/veh	3.5					
Movement	EBL	EBR	NBL	NBT	SBT	SBR
Lane Configurations						
Traffic Vol, veh/h	23	37	45	85	56	16
Future Vol, veh/h	23	37	45	85	56	16
Conflicting Peds, #/hr	0	0	0	0	0	0
Sign Control	Stop	Stop	Free	Free	Free	Free
RT Channelized	-	None	-	None	-	None
Storage Length	0	-	-	-	-	-
Veh in Median Storage, #	0	-	-	0	0	-
Grade, %	0	-	-	0	0	-
Peak Hour Factor	92	92	92	92	92	92
Heavy Vehicles, %	2	2	2	2	2	2
Mvmt Flow	25	40	49	92	61	17

Major/Minor	Minor2	Major1		Major2	
Conflicting Flow All	260	70	78	0	0
Stage 1	70	-	-	-	-
Stage 2	190	-	-	-	-
Critical Hdwy	6.42	6.22	4.12	-	-
Critical Hdwy Stg 1	5.42	-	-	-	-
Critical Hdwy Stg 2	5.42	-	-	-	-
Follow-up Hdwy	3.518	3.318	2.218	-	-
Pot Cap-1 Maneuver	729	993	1520	-	-
Stage 1	953	-	-	-	-
Stage 2	842	-	-	-	-
Platoon blocked, %				-	-
Mov Cap-1 Maneuver	704	993	1520	-	-
Mov Cap-2 Maneuver	704	-	-	-	-
Stage 1	921	-	-	-	-
Stage 2	842	-	-	-	-

Approach	EB	NB	SB
HCM Control Delay, s	9.5	2.6	0
HCM LOS	A		

























Minor Lane/Major Mvmt	NBL	NBT	EBLn1	SBT	SBR
Capacity (veh/h)	1520	-	858	-	-
HCM Lane V/C Ratio	0.032	-	0.076	-	-
HCM Control Delay (s)	7.4	0	9.5	-	-
HCM Lane LOS	A	A	A	-	-
HCM 95th %tile Q(veh)	0.1	-	0.2	-	-

HCM 6th Signalized Intersection Summary  
 2594: Ponce de Leon Blvd & Bird Road



















												
Movement	EBL	EBT	EBR	WBL	WBT	WBR	NBL	NBT	NBR	SBL	SBT	SBR
Lane Configurations												
Traffic Volume (veh/h)	202	1242	115	177	1090	183	51	353	47	165	426	59
Future Volume (veh/h)	202	1242	115	177	1090	183	51	353	47	165	426	59
Initial Q (Qb), veh	0	0	0	0	0	0	0	0	0	0	0	0
Ped-Bike Adj(A_pbT)	1.00		1.00	1.00		1.00	1.00		1.00	1.00		1.00
Parking Bus, Adj	1.00	1.00	1.00	1.00	1.00	1.00	1.00	1.00	1.00	1.00	1.00	1.00
Work Zone On Approach		No			No			No			No	
Adj Sat Flow, veh/h/ln	1670	1670	1670	1683	1683	1683	1670	1670	1670	1683	1683	1683
Adj Flow Rate, veh/h	213	1307	121	186	1147	193	54	372	49	174	448	62
Peak Hour Factor	0.95	0.95	0.95	0.95	0.95	0.95	0.95	0.95	0.95	0.95	0.95	0.95
Percent Heavy Veh, %	3	3	3	2	2	2	3	3	3	2	2	2
Cap, veh/h	240	1816	863	229	1546	259	138	413	54	171	584	359
Arrive On Green	0.07	0.57	0.57	0.06	0.56	0.56	0.04	0.15	0.15	0.07	0.18	0.18
Sat Flow, veh/h	1590	3173	1415	1603	2741	459	1590	2821	369	1603	3198	1427
Grp Volume(v), veh/h	213	1307	121	186	667	673	54	208	213	174	448	62
Grp Sat Flow(s),veh/h/ln	1590	1586	1415	1603	1599	1601	1590	1586	1604	1603	1599	1427
Q Serve(g_s), s	10.2	53.9	6.6	8.9	56.2	56.9	5.2	23.2	23.5	13.2	24.0	6.1
Cycle Q Clear(g_c), s	10.2	53.9	6.6	8.9	56.2	56.9	5.2	23.2	23.5	13.2	24.0	6.1
Prop In Lane	1.00		1.00	1.00		0.29	1.00		0.23	1.00		1.00
Lane Grp Cap(c), veh/h	240	1816	863	229	902	903	138	232	235	171	584	359
V/C Ratio(X)	0.89	0.72	0.14	0.81	0.74	0.75	0.39	0.90	0.91	1.02	0.77	0.17
Avail Cap(c_a), veh/h	304	1816	863	245	902	903	196	325	329	171	656	391
HCM Platoon Ratio	1.00	1.00	1.00	1.00	1.00	1.00	1.00	1.00	1.00	1.00	1.00	1.00
Upstream Filter(I)	1.00	1.00	1.00	1.00	1.00	1.00	1.00	1.00	1.00	1.00	1.00	1.00
Uniform Delay (d), s/veh	33.2	28.0	15.0	30.8	29.4	29.5	63.0	75.5	75.6	66.1	69.9	52.7
Incr Delay (d2), s/veh	19.2	2.5	0.3	15.8	5.4	5.6	0.7	18.8	20.6	73.2	4.6	0.2
Initial Q Delay(d3),s/veh	0.0	0.0	0.0	0.0	0.0	0.0	0.0	0.0	0.0	0.0	0.0	0.0
%ile BackOfQ(50%),veh/ln	6.6	20.9	2.3	5.7	22.8	23.1	2.1	10.7	11.1	5.7	10.3	2.3
Unsig. Movement Delay, s/veh												
LnGrp Delay(d),s/veh	52.3	30.5	15.3	46.6	34.8	35.1	63.7	94.2	96.2	139.3	74.5	52.9
LnGrp LOS	D	C	B	D	C	D	E	F	F	F	E	D
Approach Vol, veh/h		1641			1526			475			684	
Approach Delay, s/veh		32.2			36.3			91.6			89.0	
Approach LOS		C			D			F			F	
Timer - Assigned Phs	1	2	3	4	5	6	7	8				
Phs Duration (G+Y+Rc), s	17.2	109.3	13.5	39.9	18.7	107.8	20.0	33.4				
Change Period (Y+Rc), s	* 6.3	* 6.3	* 6.8	7.1	* 6.3	* 6.3	* 6.8	7.1				
Max Green Setting (Gmax), s	* 13	* 91	* 13	36.9	* 20	* 84	* 13	36.9				
Max Q Clear Time (g_c+I1), s	10.9	0.0	7.2	26.0	12.2	0.0	15.2	25.5				
Green Ext Time (p_c), s	0.0	0.0	0.0	1.2	0.2	0.0	0.0	0.8				
<b>Intersection Summary</b>												
HCM 6th Ctrl Delay			49.2									
HCM 6th LOS			D									
<b>Notes</b>												
* HCM 6th computational engine requires equal clearance times for the phases crossing the barrier.												

# HCM 6th Signalized Intersection Summary

## 2595: LeJeune Rd & Bird Road

												
Movement	EBL	EBT	EBR	WBL	WBT	WBR	NBL	NBT	NBR	SBL	SBT	SBR
Lane Configurations												
Traffic Volume (veh/h)	181	1376	168	84	961	140	147	806	40	157	730	53
Future Volume (veh/h)	181	1376	168	84	961	140	147	806	40	157	730	53
Initial Q (Qb), veh	0	0	0	0	0	0	0	0	0	0	0	0
Ped-Bike Adj(A_pbT)	1.00		1.00	1.00		1.00	1.00		1.00	1.00		1.00
Parking Bus, Adj	1.00	1.00	1.00	1.00	1.00	1.00	1.00	1.00	1.00	1.00	1.00	1.00
Work Zone On Approach		No			No			No			No	
Adj Sat Flow, veh/h/ln	1856	1856	1856	1856	1856	1856	1870	1870	1870	1856	1856	1856
Adj Flow Rate, veh/h	183	1390	170	85	971	141	148	814	40	159	737	54
Peak Hour Factor	0.99	0.99	0.99	0.99	0.99	0.99	0.99	0.99	0.99	0.99	0.99	0.99
Percent Heavy Veh, %	3	3	3	3	3	3	2	2	2	3	3	3
Cap, veh/h	325	1828	815	166	2186	317	182	861	42	155	784	57
Arrive On Green	0.06	0.52	0.52	0.03	0.49	0.49	0.07	0.25	0.25	0.06	0.24	0.24
Sat Flow, veh/h	1767	3526	1572	1767	4469	647	1781	3447	169	1767	3330	244
Grp Volume(v), veh/h	183	1390	170	85	733	379	148	420	434	159	390	401
Grp Sat Flow(s),veh/h/ln	1767	1763	1572	1767	1689	1739	1781	1777	1840	1767	1763	1812
Q Serve(g_s), s	9.5	58.6	10.9	4.5	26.5	26.6	11.7	43.4	43.4	11.1	40.6	40.6
Cycle Q Clear(g_c), s	9.5	58.6	10.9	4.5	26.5	26.6	11.7	43.4	43.4	11.1	40.6	40.6
Prop In Lane	1.00		1.00	1.00		0.37	1.00		0.09	1.00		0.13
Lane Grp Cap(c), veh/h	325	1828	815	166	1652	851	182	444	460	155	415	427
V/C Ratio(X)	0.56	0.76	0.21	0.51	0.44	0.45	0.81	0.95	0.95	1.03	0.94	0.94
Avail Cap(c_a), veh/h	402	1828	815	172	1652	851	222	467	483	155	463	476
HCM Platoon Ratio	1.00	1.00	1.00	1.00	1.00	1.00	1.00	1.00	1.00	1.00	1.00	1.00
Upstream Filter(l)	1.00	1.00	1.00	1.00	1.00	1.00	0.92	0.92	0.92	1.00	1.00	1.00
Uniform Delay (d), s/veh	23.4	35.8	24.3	32.5	31.2	31.2	53.7	68.9	68.9	59.8	70.2	70.2
Incr Delay (d2), s/veh	1.8	3.0	0.6	0.9	0.9	1.7	13.1	26.1	25.5	79.5	25.7	25.4
Initial Q Delay(d3),s/veh	0.0	0.0	0.0	0.0	0.0	0.0	0.0	0.0	0.0	0.0	0.0	0.0
%ile BackOfQ(50%),veh/ln	4.2	25.9	4.3	2.0	11.2	11.8	5.9	22.8	23.5	5.5	21.2	21.7
Unsig. Movement Delay, s/veh												
LnGrp Delay(d),s/veh	25.3	38.8	24.9	33.4	32.0	32.9	66.8	95.0	94.4	139.3	95.9	95.6
LnGrp LOS	C	D	C	C	C	C	E	F	F	F	F	F
Approach Vol, veh/h		1743			1197			1002			950	
Approach Delay, s/veh		36.0			32.4			90.6			103.0	
Approach LOS		D			C			F			F	
Timer - Assigned Phs	1	2	3	4	5	6	7	8				
Phs Duration (G+Y+Rc), s	12.4	103.0	20.7	50.9	17.9	97.5	18.0	53.6				
Change Period (Y+Rc), s	6.0	6.0	6.9	6.9	6.0	6.0	6.9	6.9				
Max Green Setting (Gmax), s	7.0	87.0	18.0	49.1	20.0	74.0	11.1	49.1				
Max Q Clear Time (g_c+I1), s	6.5	0.0	13.7	42.6	11.5	0.0	13.1	45.4				
Green Ext Time (p_c), s	0.0	0.0	0.1	1.4	0.4	0.0	0.0	1.1				
<b>Intersection Summary</b>												
HCM 6th Ctrl Delay			59.3									
HCM 6th LOS			E									

HCM 6th Signalized Intersection Summary  
 3272: LeJeune Rd & Altara Ave

												
Movement	EBL	EBT	EBR	WBL	WBT	WBR	NBL	NBT	NBR	SBL	SBT	SBR
Lane Configurations												
Traffic Volume (veh/h)	0	0	0	100	0	139	0	878	85	62	929	0
Future Volume (veh/h)	0	0	0	100	0	139	0	878	85	62	929	0
Initial Q (Qb), veh	0	0	0	0	0	0	0	0	0	0	0	0
Ped-Bike Adj(A_pbT)	1.00		1.00	1.00		1.00	1.00		1.00	1.00		1.00
Parking Bus, Adj	1.00	1.00	1.00	1.00	1.00	1.00	1.00	1.00	1.00	1.00	1.00	1.00
Work Zone On Approach		No			No			No			No	
Adj Sat Flow, veh/h/ln	1900	1900	1900	1870	1870	1870	1870	1870	1870	1870	1870	0
Adj Flow Rate, veh/h	0	0	0	108	0	149	0	944	91	67	999	0
Peak Hour Factor	0.93	0.93	0.93	0.93	0.93	0.93	0.93	0.93	0.93	0.93	0.93	0.93
Percent Heavy Veh, %	0	0	0	2	2	2	2	2	2	2	2	0
Cap, veh/h	0	348	0	142	3	161	40	2451	236	392	2660	0
Arrive On Green	0.00	0.00	0.00	0.18	0.00	0.18	0.00	0.75	0.75	0.75	0.75	0.00
Sat Flow, veh/h	0	1900	0	620	16	878	564	3275	316	545	3647	0
Grp Volume(v), veh/h	0	0	0	257	0	0	0	512	523	67	999	0
Grp Sat Flow(s),veh/h/ln	0	1900	0	1514	0	0	564	1777	1814	545	1777	0
Q Serve(g_s), s	0.0	0.0	0.0	29.3	0.0	0.0	0.0	18.3	18.3	8.9	17.7	0.0
Cycle Q Clear(g_c), s	0.0	0.0	0.0	30.0	0.0	0.0	0.0	18.3	18.3	27.3	17.7	0.0
Prop In Lane	0.00		0.00	0.42		0.58	1.00		0.17	1.00		0.00
Lane Grp Cap(c), veh/h	0	348	0	306	0	0	40	1330	1357	392	2660	0
V/C Ratio(X)	0.00	0.00	0.00	0.84	0.00	0.00	0.00	0.39	0.39	0.17	0.38	0.00
Avail Cap(c_a), veh/h	0	875	0	725	0	0	40	1330	1357	392	2660	0
HCM Platoon Ratio	1.00	1.00	1.00	1.00	1.00	1.00	1.00	1.00	1.00	1.00	1.00	1.00
Upstream Filter(l)	0.00	0.00	0.00	1.00	0.00	0.00	0.00	1.00	1.00	0.54	0.54	0.00
Uniform Delay (d), s/veh	0.0	0.0	0.0	72.3	0.0	0.0	0.0	8.0	8.0	12.8	7.9	0.0
Incr Delay (d2), s/veh	0.0	0.0	0.0	6.2	0.0	0.0	0.0	0.8	0.8	0.5	0.2	0.0
Initial Q Delay(d3),s/veh	0.0	0.0	0.0	0.0	0.0	0.0	0.0	0.0	0.0	0.0	0.0	0.0
%ile BackOfQ(50%),veh/ln	0.0	0.0	0.0	12.3	0.0	0.0	0.0	7.1	7.3	1.2	6.7	0.0
Unsig. Movement Delay, s/veh												
LnGrp Delay(d),s/veh	0.0	0.0	0.0	78.4	0.0	0.0	0.0	8.8	8.8	13.3	8.1	0.0
LnGrp LOS	A	A	A	E	A	A	A	A	A	B	A	A
Approach Vol, veh/h		0			257			1035			1066	
Approach Delay, s/veh		0.0			78.4			8.8			8.5	
Approach LOS					E			A			A	
Timer - Assigned Phs		2		4		6		8				
Phs Duration (G+Y+Rc), s		140.7		39.3		140.7		39.3				
Change Period (Y+Rc), s		6.0		* 6.3		6.0		* 6.3				
Max Green Setting (Gmax), s		84.8		* 83		84.8		* 83				
Max Q Clear Time (g_c+I1), s		0.0		0.0		0.0		32.0				
Green Ext Time (p_c), s		0.0		0.0		0.0		0.9				
<b>Intersection Summary</b>												
HCM 6th Ctrl Delay				16.3								
HCM 6th LOS				B								
<b>Notes</b>												
* HCM 6th computational engine requires equal clearance times for the phases crossing the barrier.												



HCM 6th Signalized Intersection Summary  
 6165: Ponce de Leon Blvd & San Lorenzo Ave



Movement	EBL	EBR	NBL	NBT	SBT	SBR
Lane Configurations						
Traffic Volume (veh/h)	8	24	42	482	544	23
Future Volume (veh/h)	8	24	42	482	544	23
Initial Q (Qb), veh	0	0	0	0	0	0
Ped-Bike Adj(A_pbT)	1.00	1.00	1.00			1.00
Parking Bus, Adj	1.00	1.00	1.00	1.00	1.00	1.00
Work Zone On Approach	No			No	No	
Adj Sat Flow, veh/h/ln	1900	1900	1856	1856	1870	1870
Adj Flow Rate, veh/h	9	26	45	518	585	25
Peak Hour Factor	0.93	0.93	0.93	0.93	0.93	0.93
Percent Heavy Veh, %	0	0	3	3	2	2
Cap, veh/h	19	55	647	2787	2334	100
Arrive On Green	0.05	0.05	0.04	0.79	0.67	0.67
Sat Flow, veh/h	396	1145	1767	3618	3566	148
Grp Volume(v), veh/h	36	0	45	518	299	311
Grp Sat Flow(s),veh/h/ln	1585	0	1767	1763	1777	1844
Q Serve(g_s), s	1.8	0.0	0.6	2.9	5.3	5.3
Cycle Q Clear(g_c), s	1.8	0.0	0.6	2.9	5.3	5.3
Prop In Lane	0.25	0.72	1.00			0.08
Lane Grp Cap(c), veh/h	76	0	647	2787	1195	1240
V/C Ratio(X)	0.47	0.00	0.07	0.19	0.25	0.25
Avail Cap(c_a), veh/h	513	0	863	2787	1195	1240
HCM Platoon Ratio	1.00	1.00	1.00	1.00	1.00	1.00
Upstream Filter(I)	1.00	0.00	1.00	1.00	1.00	1.00
Uniform Delay (d), s/veh	37.1	0.0	3.2	2.1	5.2	5.2
Incr Delay (d2), s/veh	3.3	0.0	0.0	0.1	0.5	0.5
Initial Q Delay(d3),s/veh	0.0	0.0	0.0	0.0	0.0	0.0
%ile BackOfQ(50%),veh/ln	0.8	0.0	0.1	0.6	1.8	1.8
Unsig. Movement Delay, s/veh						
LnGrp Delay(d),s/veh	40.4	0.0	3.2	2.2	5.7	5.7
LnGrp LOS	D	A	A	A	A	A
Approach Vol, veh/h	36			563	610	
Approach Delay, s/veh	40.4			2.3	5.7	
Approach LOS	D			A	A	
Timer - Assigned Phs		2		4	5	6
Phs Duration (G+Y+Rc), s		69.8		10.2	9.5	60.4
Change Period (Y+Rc), s		6.6		* 6.3	* 6.3	6.6
Max Green Setting (Gmax), s		41.2		* 26	* 13	22.0
Max Q Clear Time (g_c+I1), s		0.0		3.8	2.6	0.0
Green Ext Time (p_c), s		0.0		0.1	0.0	0.0
<b>Intersection Summary</b>						
HCM 6th Ctrl Delay			5.1			
HCM 6th LOS			A			
<b>Notes</b>						
* HCM 6th computational engine requires equal clearance times for the phases crossing the barrier.						

## Roadway Segment LOS

---

## Arterial Level of Service

---

### Arterial Level of Service: NB Ponce de Leon Blvd

---

Cross Street	Arterial Class	Flow Speed	Running Time	Signal Delay	Travel Time (s)	Dist (mi)	Arterial Speed	Arterial LOS
San Lorenzo Ave	III	30	11.2	3.3	14.5	0.08	19.8	C
Bird Road	III	30	23.7	86.6	110.3	0.19	6.1	F
Total	III		34.9	89.9	124.8	0.27	7.7	F

---

### Arterial Level of Service: SB Ponce de Leon Blvd

---

Cross Street	Arterial Class	Flow Speed	Running Time	Signal Delay	Travel Time (s)	Dist (mi)	Arterial Speed	Arterial LOS
Bird Road	III	30	24.3	79.0	103.3	0.19	6.7	F
San Lorenzo Ave	III	30	23.7	7.4	31.1	0.19	21.6	C
Total	III		48.0	86.4	134.4	0.38	10.1	E

## Arterial Level of Service

---

### Arterial Level of Service: NB LeJeune Rd

---

Cross Street	Arterial Class	Flow Speed	Running Time	Signal Delay	Travel Time (s)	Dist (mi)	Arterial Speed	Arterial LOS
Altara Ave	II	35	19.9	9.2	29.1	0.16	19.7	D
Bird Road	II	40	13.3	77.8	91.1	0.12	4.6	F
Total	II		33.2	87.0	120.2	0.28	8.2	F

---

### Arterial Level of Service: SB LeJeune Rd

---

Cross Street	Arterial Class	Flow Speed	Running Time	Signal Delay	Travel Time (s)	Dist (mi)	Arterial Speed	Arterial LOS
Bird Road	II	40	22.0	82.2	104.2	0.19	6.6	F
Altara Ave	II	35	14.5	9.3	23.8	0.12	17.5	D
Total	II		36.5	91.5	128.0	0.31	8.6	F

## Arterial Level of Service

---

### Arterial Level of Service: EB Bird Road

---

Cross Street	Arterial Class	Flow Speed	Running Time	Signal Delay	Travel Time (s)	Dist (mi)	Arterial Speed	Arterial LOS
LeJeune Rd	III	35	16.6	45.1	61.7	0.13	7.6	F
Ponce de Leon Blvd	III	35	26.3	39.5	65.8	0.22	12.0	E
Total	III		42.9	84.6	127.5	0.35	9.8	F

---

### Arterial Level of Service: WB Bird Road

---

Cross Street	Arterial Class	Flow Speed	Running Time	Signal Delay	Travel Time (s)	Dist (mi)	Arterial Speed	Arterial LOS
Ponce de Leon Blvd	III	35	18.6	47.6	66.2	0.15	7.9	F
LeJeune Rd	III	35	26.3	38.1	64.4	0.22	12.2	E
Total	III		44.9	85.7	130.6	0.36	10.0	E

## Arterial Level of Service

---

### Arterial Level of Service: WB Altara Ave

---

Cross Street	Arterial Class	Flow Speed	Running Time	Signal Delay	Travel Time (s)	Dist (mi)	Arterial Speed	Arterial LOS
LeJeune Rd	III	30	27.9	0.0	27.9	0.22	28.3	B
Total	III		27.9	0.0	27.9	0.22	28.3	B

## PM Peak Hour Future with Proposed Development Conditions

---

## Intersection LOS

---





















HCM 6th Signalized Intersection Summary  
 2594: Ponce de Leon Blvd & Bird Road

Movement	EBL	EBT	EBR	WBL	WBT	WBR	NBL	NBT	NBR	SBL	SBT	SBR
Lane Configurations												
Traffic Volume (veh/h)	166	1070	79	148	1573	121	102	332	67	124	455	148
Future Volume (veh/h)	166	1070	79	148	1573	121	102	332	67	124	455	148
Initial Q (Qb), veh	0	0	0	0	0	0	0	0	0	0	0	0
Ped-Bike Adj(A_pbT)	1.00		1.00	1.00		1.00	1.00		1.00	1.00		1.00
Parking Bus, Adj	1.00	1.00	1.00	1.00	1.00	1.00	1.00	1.00	1.00	1.00	1.00	1.00
Work Zone On Approach		No			No			No			No	
Adj Sat Flow, veh/h/ln	1697	1697	1697	1697	1697	1697	1683	1683	1683	1683	1683	1683
Adj Flow Rate, veh/h	171	1103	81	153	1622	125	105	342	69	128	469	153
Peak Hour Factor	0.97	0.97	0.97	0.97	0.97	0.97	0.97	0.97	0.97	0.97	0.97	0.97
Percent Heavy Veh, %	1	1	1	1	1	1	2	2	2	2	2	2
Cap, veh/h	136	1952	920	377	1886	144	111	380	76	144	528	281
Arrive On Green	0.06	1.00	1.00	0.05	0.62	0.62	0.03	0.14	0.14	0.06	0.17	0.17
Sat Flow, veh/h	1616	3224	1438	1616	3035	232	1603	2657	530	1603	3198	1427
Grp Volume(v), veh/h	171	1103	81	153	855	892	105	204	207	128	469	153
Grp Sat Flow(s),veh/h/ln	1616	1612	1438	1616	1612	1655	1603	1599	1588	1603	1599	1427
Q Serve(g_s), s	5.7	0.0	0.0	6.5	77.0	79.6	6.2	22.6	23.1	10.2	25.8	17.4
Cycle Q Clear(g_c), s	5.7	0.0	0.0	6.5	77.0	79.6	6.2	22.6	23.1	10.2	25.8	17.4
Prop In Lane	1.00		1.00	1.00		0.14	1.00		0.33	1.00		1.00
Lane Grp Cap(c), veh/h	136	1952	920	377	1002	1029	111	228	227	144	528	281
V/C Ratio(X)	1.26	0.57	0.09	0.41	0.85	0.87	0.95	0.89	0.91	0.89	0.89	0.55
Avail Cap(c_a), veh/h	136	1952	920	414	1002	1029	111	283	281	144	638	330
HCM Platoon Ratio	2.00	2.00	2.00	1.00	1.00	1.00	1.00	1.00	1.00	1.00	1.00	1.00
Upstream Filter(I)	1.00	1.00	1.00	1.00	1.00	1.00	1.00	1.00	1.00	1.00	1.00	1.00
Uniform Delay (d), s/veh	43.3	0.0	0.0	12.0	27.5	28.0	74.6	75.8	76.0	68.0	73.5	65.0
Incr Delay (d2), s/veh	162.1	1.2	0.2	0.3	9.2	9.8	68.2	23.6	27.0	43.5	12.1	1.2
Initial Q Delay(d3),s/veh	0.0	0.0	0.0	0.0	0.0	0.0	0.0	0.0	0.0	0.0	0.0	0.0
%ile BackOfQ(50%),veh/ln	10.0	0.3	0.0	2.4	31.4	33.4	4.3	10.9	11.2	3.2	11.6	6.5
Unsig. Movement Delay, s/veh												
LnGrp Delay(d),s/veh	205.4	1.2	0.2	12.2	36.6	37.8	142.7	99.4	103.0	111.5	85.7	66.3
LnGrp LOS	F	A	A	B	D	D	F	F	F	F	F	E
Approach Vol, veh/h		1355			1900			516			750	
Approach Delay, s/veh		26.9			35.2			109.7			86.1	
Approach LOS		C			D			F			F	
Timer - Assigned Phs	1	2	3	4	5	6	7	8				
Phs Duration (G+Y+Rc), s	14.9	115.3	13.0	36.8	12.0	118.2	17.0	32.8				
Change Period (Y+Rc), s	* 6.3	* 6.3	* 6.8	7.1	* 6.3	* 6.3	* 6.8	7.1				
Max Green Setting (Gmax), s	* 13	* 99	* 6.2	35.9	* 5.7	* 1.1E2	* 10	31.9				
Max Q Clear Time (g_c+I1), s	8.5	0.0	8.2	27.8	7.7	0.0	12.2	25.1				
Green Ext Time (p_c), s	0.1	0.0	0.0	1.3	0.0	0.0	0.0	0.6				
<b>Intersection Summary</b>												
HCM 6th Ctrl Delay			49.7									
HCM 6th LOS			D									
<b>Notes</b>												
* HCM 6th computational engine requires equal clearance times for the phases crossing the barrier.												

HCM 6th Signalized Intersection Summary  
 2595: LeJeune Rd & Bird Road

Movement	EBL	EBT	EBR	WBL	WBT	WBR	NBL	NBT	NBR	SBL	SBT	SBR
Lane Configurations												
Traffic Volume (veh/h)	110	1040	170	139	1474	186	160	791	78	162	878	71
Future Volume (veh/h)	110	1040	170	139	1474	186	160	791	78	162	878	71
Initial Q (Qb), veh	0	0	0	0	0	0	0	0	0	0	0	0
Ped-Bike Adj(A_pbT)	1.00		1.00	1.00		1.00	1.00		1.00	1.00		1.00
Parking Bus, Adj	1.00	1.00	1.00	1.00	1.00	1.00	1.00	1.00	1.00	1.00	1.00	1.00
Work Zone On Approach		No			No			No			No	
Adj Sat Flow, veh/h/ln	1885	1885	1885	1885	1885	1885	1870	1870	1870	1885	1885	1885
Adj Flow Rate, veh/h	116	1095	179	146	1552	196	168	833	82	171	924	75
Peak Hour Factor	0.95	0.95	0.95	0.95	0.95	0.95	0.95	0.95	0.95	0.95	0.95	0.95
Percent Heavy Veh, %	1	1	1	1	1	1	2	2	2	1	1	1
Cap, veh/h	222	1708	762	245	2327	293	113	955	94	135	980	80
Arrive On Green	0.03	0.48	0.48	0.11	1.00	1.00	0.05	0.39	0.39	0.03	0.29	0.29
Sat Flow, veh/h	1795	3582	1598	1795	4628	583	1781	3268	322	1795	3355	272
Grp Volume(v), veh/h	116	1095	179	146	1150	598	168	453	462	171	493	506
Grp Sat Flow(s),veh/h/ln	1795	1791	1598	1795	1716	1780	1781	1777	1812	1795	1791	1836
Q Serve(g_s), s	5.0	41.5	11.9	7.7	0.0	0.0	6.1	42.4	42.5	6.1	48.4	48.4
Cycle Q Clear(g_c), s	5.0	41.5	11.9	7.7	0.0	0.0	6.1	42.4	42.5	6.1	48.4	48.4
Prop In Lane	1.00		1.00	1.00		0.33	1.00		0.18	1.00		0.15
Lane Grp Cap(c), veh/h	222	1708	762	245	1725	895	113	519	529	135	523	536
V/C Ratio(X)	0.52	0.64	0.23	0.60	0.67	0.67	1.48	0.87	0.87	1.26	0.94	0.94
Avail Cap(c_a), veh/h	222	1708	762	268	1725	895	113	583	595	135	588	603
HCM Platoon Ratio	1.00	1.00	1.00	2.00	2.00	2.00	1.33	1.33	1.33	1.00	1.00	1.00
Upstream Filter(l)	1.00	1.00	1.00	1.00	1.00	1.00	0.91	0.91	0.91	1.00	1.00	1.00
Uniform Delay (d), s/veh	24.1	35.5	27.7	26.9	0.0	0.0	59.7	51.9	51.9	63.7	62.2	62.2
Incr Delay (d2), s/veh	2.6	1.9	0.7	1.8	2.1	3.9	254.7	11.4	11.3	164.1	22.4	22.0
Initial Q Delay(d3),s/veh	0.0	0.0	0.0	0.0	0.0	0.0	0.0	0.0	0.0	0.0	0.0	0.0
%ile BackOfQ(50%),veh/ln	3.0	18.6	4.8	3.1	0.5	1.0	10.3	19.6	19.9	9.5	25.1	25.7
Unsig. Movement Delay, s/veh												
LnGrp Delay(d),s/veh	26.7	37.3	28.5	28.6	2.1	3.9	314.5	63.4	63.2	227.8	84.6	84.2
LnGrp LOS	C	D	C	C	A	A	F	E	E	F	F	F
Approach Vol, veh/h		1390			1894			1083			1170	
Approach Delay, s/veh		35.3			4.7			102.3			105.4	
Approach LOS		D			A			F			F	
Timer - Assigned Phs	1	2	3	4	5	6	7	8				
Phs Duration (G+Y+Rc), s	15.7	91.8	13.0	59.5	11.0	96.5	13.0	59.5				
Change Period (Y+Rc), s	6.0	6.0	6.9	6.9	6.0	6.0	6.9	6.9				
Max Green Setting (Gmax), s	12.0	77.0	6.1	59.1	5.0	84.0	6.1	59.1				
Max Q Clear Time (g_c+I1), s	9.7	0.0	8.1	50.4	7.0	0.0	8.1	44.5				
Green Ext Time (p_c), s	0.0	0.0	0.0	2.1	0.0	0.0	0.0	2.4				
<b>Intersection Summary</b>												
HCM 6th Ctrl Delay				52.7								
HCM 6th LOS				D								

HCM 6th Signalized Intersection Summary  
 3272: LeJeune Rd & Altara Ave

												
Movement	EBL	EBT	EBR	WBL	WBT	WBR	NBL	NBT	NBR	SBL	SBT	SBR
Lane Configurations												
Traffic Volume (veh/h)	0	0	0	157	0	174	0	857	129	118	1052	0
Future Volume (veh/h)	0	0	0	157	0	174	0	857	129	118	1052	0
Initial Q (Qb), veh	0	0	0	0	0	0	0	0	0	0	0	0
Ped-Bike Adj(A_pbT)	1.00		1.00	1.00		1.00	1.00		1.00	1.00		1.00
Parking Bus, Adj	1.00	1.00	1.00	1.00	1.00	1.00	1.00	1.00	1.00	1.00	1.00	1.00
Work Zone On Approach		No			No			No			No	
Adj Sat Flow, veh/h/ln	1870	1870	1870	1885	1885	1885	1885	1885	1885	1885	1885	0
Adj Flow Rate, veh/h	0	0	0	165	0	183	0	902	136	124	1107	0
Peak Hour Factor	0.95	0.95	0.95	0.95	0.95	0.95	0.95	0.95	0.95	0.95	0.95	0.95
Percent Heavy Veh, %	2	2	2	1	1	1	1	1	1	1	1	0
Cap, veh/h	0	448	0	201	0	191	40	2160	326	350	2479	0
Arrive On Green	0.00	0.00	0.00	0.24	0.00	0.24	0.00	0.69	0.69	1.00	1.00	0.00
Sat Flow, veh/h	0	1870	0	717	0	796	513	3121	471	548	3676	0
Grp Volume(v), veh/h	0	0	0	348	0	0	0	518	520	124	1107	0
Grp Sat Flow(s),veh/h/ln	0	1870	0	1513	0	0	513	1791	1800	548	1791	0
Q Serve(g_s), s	0.0	0.0	0.0	40.9	0.0	0.0	0.0	22.5	22.5	11.0	0.0	0.0
Cycle Q Clear(g_c), s	0.0	0.0	0.0	40.9	0.0	0.0	0.0	22.5	22.5	33.5	0.0	0.0
Prop In Lane	0.00		0.00	0.47		0.53	1.00		0.26	1.00		0.00
Lane Grp Cap(c), veh/h	0	448	0	392	0	0	40	1239	1246	350	2479	0
V/C Ratio(X)	0.00	0.00	0.00	0.89	0.00	0.00	0.00	0.42	0.42	0.35	0.45	0.00
Avail Cap(c_a), veh/h	0	464	0	405	0	0	40	1239	1246	350	2479	0
HCM Platoon Ratio	1.00	1.00	1.00	1.00	1.00	1.00	1.00	1.00	1.00	2.00	2.00	1.00
Upstream Filter(l)	0.00	0.00	0.00	1.00	0.00	0.00	0.00	1.00	1.00	0.50	0.50	0.00
Uniform Delay (d), s/veh	0.0	0.0	0.0	67.6	0.0	0.0	0.0	12.0	12.0	3.0	0.0	0.0
Incr Delay (d2), s/veh	0.0	0.0	0.0	20.2	0.0	0.0	0.0	1.0	1.0	1.4	0.3	0.0
Initial Q Delay(d3),s/veh	0.0	0.0	0.0	0.0	0.0	0.0	0.0	0.0	0.0	0.0	0.0	0.0
%ile BackOfQ(50%),veh/ln	0.0	0.0	0.0	18.1	0.0	0.0	0.0	9.3	9.4	1.0	0.1	0.0
Unsig. Movement Delay, s/veh												
LnGrp Delay(d),s/veh	0.0	0.0	0.0	87.8	0.0	0.0	0.0	13.0	13.0	4.4	0.3	0.0
LnGrp LOS	A	A	A	F	A	A	A	B	B	A	A	A
Approach Vol, veh/h		0			348			1038			1231	
Approach Delay, s/veh		0.0			87.8			13.0			0.7	
Approach LOS					F			B			A	
Timer - Assigned Phs		2		4		6		8				
Phs Duration (G+Y+Rc), s		130.6		49.4		130.6		49.4				
Change Period (Y+Rc), s		6.0		* 6.3		6.0		* 6.3				
Max Green Setting (Gmax), s		123.0		* 45		123.0		* 45				
Max Q Clear Time (g_c+I1), s		0.0		0.0		0.0		42.9				
Green Ext Time (p_c), s		0.0		0.0		0.0		0.3				
<b>Intersection Summary</b>												
HCM 6th Ctrl Delay				17.2								
HCM 6th LOS				B								
<b>Notes</b>												
* HCM 6th computational engine requires equal clearance times for the phases crossing the barrier.												

HCM 6th Signalized Intersection Summary  
 6165: Ponce de Leon Blvd & San Lorenzo Ave



Movement	EBL	EBR	NBL	NBT	SBT	SBR
Lane Configurations						
Traffic Volume (veh/h)	25	46	63	448	478	77
Future Volume (veh/h)	25	46	63	448	478	77
Initial Q (Qb), veh	0	0	0	0	0	0
Ped-Bike Adj(A_pbT)	1.00	1.00	1.00			1.00
Parking Bus, Adj	1.00	1.00	1.00	1.00	1.00	1.00
Work Zone On Approach	No			No	No	
Adj Sat Flow, veh/h/ln	1900	1900	1870	1870	1870	1870
Adj Flow Rate, veh/h	26	47	65	462	493	79
Peak Hour Factor	0.97	0.97	0.97	0.97	0.97	0.97
Percent Heavy Veh, %	0	0	2	2	2	2
Cap, veh/h	42	75	656	2730	1970	314
Arrive On Green	0.07	0.07	0.05	0.77	0.64	0.64
Sat Flow, veh/h	590	1066	1781	3647	3163	490
Grp Volume(v), veh/h	74	0	65	462	284	288
Grp Sat Flow(s),veh/h/ln	1679	0	1781	1777	1777	1782
Q Serve(g_s), s	3.4	0.0	0.9	2.8	5.5	5.5
Cycle Q Clear(g_c), s	3.4	0.0	0.9	2.8	5.5	5.5
Prop In Lane	0.35	0.64	1.00			0.27
Lane Grp Cap(c), veh/h	119	0	656	2730	1140	1144
V/C Ratio(X)	0.62	0.00	0.10	0.17	0.25	0.25
Avail Cap(c_a), veh/h	371	0	698	2730	1140	1144
HCM Platoon Ratio	1.00	1.00	1.00	1.00	1.00	1.00
Upstream Filter(l)	1.00	0.00	1.00	1.00	1.00	1.00
Uniform Delay (d), s/veh	36.1	0.0	3.8	2.5	6.1	6.1
Incr Delay (d2), s/veh	4.0	0.0	0.0	0.1	0.5	0.5
Initial Q Delay(d3),s/veh	0.0	0.0	0.0	0.0	0.0	0.0
%ile BackOfQ(50%),veh/ln	1.5	0.0	0.2	0.7	1.9	1.9
Unsig. Movement Delay, s/veh						
LnGrp Delay(d),s/veh	40.1	0.0	3.8	2.6	6.6	6.7
LnGrp LOS	D	A	A	A	A	A
Approach Vol, veh/h	74			527	572	
Approach Delay, s/veh	40.1			2.8	6.6	
Approach LOS	D			A	A	
Timer - Assigned Phs		2		4	5	6
Phs Duration (G+Y+Rc), s		68.1		11.9	10.1	57.9
Change Period (Y+Rc), s		6.6		* 6.3	* 6.3	6.6
Max Green Setting (Gmax), s		49.4		* 18	* 5.7	37.4
Max Q Clear Time (g_c+I1), s		0.0		5.4	2.9	0.0
Green Ext Time (p_c), s		0.0		0.1	0.0	0.0
<b>Intersection Summary</b>						
HCM 6th Ctrl Delay			7.0			
HCM 6th LOS			A			
<b>Notes</b>						
* HCM 6th computational engine requires equal clearance times for the phases crossing the barrier.						

HCM 6th TWSC  
1: Salzedo St & Bird Road

Intersection						
Int Delay, s/veh	1					
Movement	EBT	EBR	WBL	WBT	NBL	NBR
Lane Configurations	↑↑	↑		↑↑↑	↑	
Traffic Vol, veh/h	1192	50	0	1806	25	35
Future Vol, veh/h	1192	50	0	1806	25	35
Conflicting Peds, #/hr	0	12	0	0	0	0
Sign Control	Free	Free	Free	Free	Stop	Stop
RT Channelized	-	None	-	None	-	None
Storage Length	-	208	-	-	0	-
Veh in Median Storage, #	0	-	-	0	0	-
Grade, %	0	-	-	0	0	-
Peak Hour Factor	97	97	97	97	97	97
Heavy Vehicles, %	1	1	1	1	2	2
Mvmt Flow	1229	52	0	1862	26	36

Major/Minor	Major1	Major2	Minor1		
Conflicting Flow All	0	0	-	-	1986 627
Stage 1	-	-	-	-	1241 -
Stage 2	-	-	-	-	745 -
Critical Hdwy	-	-	-	-	6.29 6.94
Critical Hdwy Stg 1	-	-	-	-	5.84 -
Critical Hdwy Stg 2	-	-	-	-	6.04 -
Follow-up Hdwy	-	-	-	-	3.67 3.32
Pot Cap-1 Maneuver	-	-	0	-	71 426
Stage 1	-	-	0	-	231 -
Stage 2	-	-	0	-	401 -
Platoon blocked, %	-	-	-	-	
Mov Cap-1 Maneuver	-	-	-	-	70 421
Mov Cap-2 Maneuver	-	-	-	-	70 -
Stage 1	-	-	-	-	228 -
Stage 2	-	-	-	-	401 -

Approach	EB	WB	NB
HCM Control Delay, s	0	0	51.9
HCM LOS			F

Minor Lane/Major Mvmt	NBLn1	EBT	EBR	WBT
Capacity (veh/h)	136	-	-	-
HCM Lane V/C Ratio	0.455	-	-	-
HCM Control Delay (s)	51.9	-	-	-
HCM Lane LOS	F	-	-	-
HCM 95th %tile Q(veh)	2	-	-	-

HCM 6th TWSC  
 2: Aurora St & Bird Road

Intersection						
Int Delay, s/veh	0.6					
Movement	EBT	EBR	WBL	WBT	NBL	NBR
Lane Configurations	↑↑	↑		↑↑		↑
Traffic Vol, veh/h	1192	49	0	1798	0	112
Future Vol, veh/h	1192	49	0	1798	0	112
Conflicting Peds, #/hr	0	10	0	0	0	0
Sign Control	Free	Free	Free	Free	Stop	Stop
RT Channelized	-	None	-	None	-	None
Storage Length	-	208	-	-	-	0
Veh in Median Storage, #	0	-	-	0	0	-
Grade, %	0	-	-	0	0	-
Peak Hour Factor	97	97	97	97	97	92
Heavy Vehicles, %	1	1	1	1	5	5
Mvmt Flow	1229	51	0	1854	0	122

Major/Minor	Major1	Major2	Minor1		
Conflicting Flow All	0	0	-	-	625
Stage 1	-	-	-	-	-
Stage 2	-	-	-	-	-
Critical Hdwy	-	-	-	-	7
Critical Hdwy Stg 1	-	-	-	-	-
Critical Hdwy Stg 2	-	-	-	-	-
Follow-up Hdwy	-	-	-	-	3.35
Pot Cap-1 Maneuver	-	-	0	-	420
Stage 1	-	-	0	-	-
Stage 2	-	-	0	-	-
Platoon blocked, %	-	-	-	-	-
Mov Cap-1 Maneuver	-	-	-	-	416
Mov Cap-2 Maneuver	-	-	-	-	-
Stage 1	-	-	-	-	-
Stage 2	-	-	-	-	-

Approach	EB	WB	NB
HCM Control Delay, s	0	0	17.2
HCM LOS			C

Minor Lane/Major Mvmt	NBLn1	EBT	EBR	WBT
Capacity (veh/h)	416	-	-	-
HCM Lane V/C Ratio	0.293	-	-	-
HCM Control Delay (s)	17.2	-	-	-
HCM Lane LOS	C	-	-	-
HCM 95th %tile Q(veh)	1.2	-	-	-

HCM 6th TWSC  
 3: Ponce de Leon Blvd & Altara Ave

Intersection												
Int Delay, s/veh	2.7											
Movement	EBL	EBT	EBR	WBL	WBT	WBR	NBL	NBT	NBR	SBL	SBT	SBR
Lane Configurations		↕			↕			↕			↕	
Traffic Vol, veh/h	46	0	66	1	0	3	48	446	2	2	510	168
Future Vol, veh/h	46	0	66	1	0	3	48	446	2	2	510	168
Conflicting Peds, #/hr	2	0	18	18	0	2	37	0	39	39	0	37
Sign Control	Stop	Stop	Stop	Stop	Stop	Stop	Free	Free	Free	Free	Free	Free
RT Channelized	-	-	None	-	-	None	-	-	None	-	-	None
Storage Length	-	-	-	-	-	-	-	-	-	-	-	-
Veh in Median Storage, #	-	0	-	-	0	-	-	0	-	-	0	-
Grade, %	-	0	-	-	0	-	-	0	-	-	0	-
Peak Hour Factor	95	95	95	95	95	95	95	95	95	95	95	95
Heavy Vehicles, %	1	1	1	0	0	0	2	2	2	2	2	2
Mvmt Flow	48	0	69	1	0	3	51	469	2	2	537	177

Major/Minor	Minor2		Minor1		Major1				Major2			
Conflicting Flow All	1006	1279	412	902	1366	277	751	0	0	510	0	0
Stage 1	667	667	-	611	611	-	-	-	-	-	-	-
Stage 2	339	612	-	291	755	-	-	-	-	-	-	-
Critical Hdwy	7.52	6.52	6.92	7.5	6.5	6.9	4.14	-	-	4.14	-	-
Critical Hdwy Stg 1	6.52	5.52	-	6.5	5.5	-	-	-	-	-	-	-
Critical Hdwy Stg 2	6.52	5.52	-	6.5	5.5	-	-	-	-	-	-	-
Follow-up Hdwy	3.51	4.01	3.31	3.5	4	3.3	2.22	-	-	2.22	-	-
Pot Cap-1 Maneuver	197	166	592	236	149	726	854	-	-	1051	-	-
Stage 1	417	457	-	453	487	-	-	-	-	-	-	-
Stage 2	652	484	-	698	420	-	-	-	-	-	-	-
Platoon blocked, %								-	-		-	-
Mov Cap-1 Maneuver	176	141	561	183	127	698	824	-	-	1012	-	-
Mov Cap-2 Maneuver	176	141	-	183	127	-	-	-	-	-	-	-
Stage 1	369	440	-	400	430	-	-	-	-	-	-	-
Stage 2	593	427	-	599	404	-	-	-	-	-	-	-

Approach	EB		WB		NB				SB		
HCM Control Delay, s	25		13.9		1.2				0		
HCM LOS	D		B								

Minor Lane/Major Mvmt	NBL	NBT	NBR	EBLn1	WBLn1	SBL	SBT	SBR
Capacity (veh/h)	824	-	-	296	410	1012	-	-
HCM Lane V/C Ratio	0.061	-	-	0.398	0.01	0.002	-	-
HCM Control Delay (s)	9.7	0.3	-	25	13.9	8.6	0	-
HCM Lane LOS	A	A	-	D	B	A	A	-
HCM 95th %tile Q(veh)	0.2	-	-	1.8	0	0	-	-

HCM 6th TWSC  
4: Aurora St & Altara Ave

Intersection												
Int Delay, s/veh	6.4											
Movement	EBL	EBT	EBR	WBL	WBT	WBR	NBL	NBT	NBR	SBL	SBT	SBR
Lane Configurations		↕			↕			↕			↕	
Traffic Vol, veh/h	42	38	42	14	92	68	22	22	23	49	16	123
Future Vol, veh/h	42	38	42	14	92	68	22	22	23	49	16	123
Conflicting Peds, #/hr	6	0	23	23	0	6	8	0	30	30	0	8
Sign Control	Free	Free	Free	Free	Free	Free	Stop	Stop	Stop	Stop	Stop	Stop
RT Channelized	-	-	None	-	-	None	-	-	None	-	-	None
Storage Length	-	-	-	-	-	-	-	-	-	-	-	-
Veh in Median Storage, #	-	0	-	-	0	-	-	0	-	-	0	-
Grade, %	-	0	-	-	0	-	-	0	-	-	0	-
Peak Hour Factor	93	93	93	93	93	93	93	93	93	93	93	93
Heavy Vehicles, %	0	0	0	1	1	1	0	0	0	1	1	1
Mvmt Flow	45	41	45	15	99	73	24	24	25	53	17	132

Major/Minor	Major1			Major2			Minor1			Minor2		
Conflicting Flow All	178	0	0	109	0	0	425	385	117	380	371	150
Stage 1	-	-	-	-	-	-	177	177	-	172	172	-
Stage 2	-	-	-	-	-	-	248	208	-	208	199	-
Critical Hdwy	4.1	-	-	4.11	-	-	7.1	6.5	6.2	7.11	6.51	6.21
Critical Hdwy Stg 1	-	-	-	-	-	-	6.1	5.5	-	6.11	5.51	-
Critical Hdwy Stg 2	-	-	-	-	-	-	6.1	5.5	-	6.11	5.51	-
Follow-up Hdwy	2.2	-	-	2.209	-	-	3.5	4	3.3	3.509	4.009	3.309
Pot Cap-1 Maneuver	1410	-	-	1488	-	-	543	552	941	580	560	899
Stage 1	-	-	-	-	-	-	829	756	-	832	758	-
Stage 2	-	-	-	-	-	-	760	734	-	796	738	-
Platoon blocked, %		-	-		-	-						
Mov Cap-1 Maneuver	1402	-	-	1455	-	-	422	512	894	508	520	887
Mov Cap-2 Maneuver	-	-	-	-	-	-	422	512	-	508	520	-
Stage 1	-	-	-	-	-	-	783	714	-	799	744	-
Stage 2	-	-	-	-	-	-	619	721	-	702	697	-

Approach	EB			WB			NB			SB		
HCM Control Delay, s	2.6			0.6			12.5			12.1		
HCM LOS							B			B		

Minor Lane/Major Mvmt	NBLn1	EBL	EBT	EBR	WBL	WBT	WBR	SBLn1
Capacity (veh/h)	555	1402	-	-	1455	-	-	707
HCM Lane V/C Ratio	0.13	0.032	-	-	0.01	-	-	0.286
HCM Control Delay (s)	12.5	7.7	0	-	7.5	0	-	12.1
HCM Lane LOS	B	A	A	-	A	A	-	B
HCM 95th %tile Q(veh)	0.4	0.1	-	-	0	-	-	1.2



HCM 6th TWSC  
 5: Aurora St & 250 Bird Road

Intersection						
Int Delay, s/veh	4.2					
Movement	EBL	EBR	NBL	NBT	SBT	SBR
Lane Configurations						
Traffic Vol, veh/h	27	43	51	81	30	19
Future Vol, veh/h	27	43	51	81	30	19
Conflicting Peds, #/hr	0	0	0	0	0	0
Sign Control	Stop	Stop	Free	Free	Free	Free
RT Channelized	-	None	-	None	-	None
Storage Length	0	-	-	-	-	-
Veh in Median Storage, #	0	-	-	0	0	-
Grade, %	0	-	-	0	0	-
Peak Hour Factor	92	92	92	92	92	92
Heavy Vehicles, %	2	2	2	2	2	2
Mvmt Flow	29	47	55	88	33	21

Major/Minor	Minor2	Major1		Major2	
Conflicting Flow All	242	44	54	0	0
Stage 1	44	-	-	-	-
Stage 2	198	-	-	-	-
Critical Hdwy	6.42	6.22	4.12	-	-
Critical Hdwy Stg 1	5.42	-	-	-	-
Critical Hdwy Stg 2	5.42	-	-	-	-
Follow-up Hdwy	3.518	3.318	2.218	-	-
Pot Cap-1 Maneuver	746	1026	1551	-	-
Stage 1	978	-	-	-	-
Stage 2	835	-	-	-	-
Platoon blocked, %				-	-
Mov Cap-1 Maneuver	718	1026	1551	-	-
Mov Cap-2 Maneuver	718	-	-	-	-
Stage 1	942	-	-	-	-
Stage 2	835	-	-	-	-

Approach	EB	NB	SB
HCM Control Delay, s	9.5	2.9	0
HCM LOS	A		

Minor Lane/Major Mvmt	NBL	NBT	EBLn1	SBT	SBR
Capacity (veh/h)	1551	-	880	-	-
HCM Lane V/C Ratio	0.036	-	0.086	-	-
HCM Control Delay (s)	7.4	0	9.5	-	-
HCM Lane LOS	A	A	A	-	-
HCM 95th %tile Q(veh)	0.1	-	0.3	-	-

## Roadway Segment LOS

---

## Arterial Level of Service

---

### Arterial Level of Service: NB Ponce de Leon Blvd

---

Cross Street	Arterial Class	Flow Speed	Running Time	Signal Delay	Travel Time (s)	Dist (mi)	Arterial Speed	Arterial LOS
San Lorenzo Ave	III	30	11.2	3.8	15.0	0.08	19.1	C
Bird Road	III	30	23.7	89.1	112.8	0.19	6.0	F
Total	III		34.9	92.9	127.8	0.27	7.5	F

---

### Arterial Level of Service: SB Ponce de Leon Blvd

---

Cross Street	Arterial Class	Flow Speed	Running Time	Signal Delay	Travel Time (s)	Dist (mi)	Arterial Speed	Arterial LOS
Bird Road	III	30	24.3	86.1	110.4	0.19	6.2	F
San Lorenzo Ave	III	30	23.7	8.3	32.0	0.19	21.0	C
Total	III		48.0	94.4	142.4	0.38	9.6	F

## Arterial Level of Service

---

### Arterial Level of Service: NB LeJeune Rd

---

Cross Street	Arterial Class	Flow Speed	Running Time	Signal Delay	Travel Time (s)	Dist (mi)	Arterial Speed	Arterial LOS
Altara Ave	II	35	19.9	12.3	32.2	0.16	17.8	D
Bird Road	II	40	13.3	58.6	71.9	0.12	5.8	F
Total	II		33.2	70.9	104.1	0.28	9.5	F

---

### Arterial Level of Service: SB LeJeune Rd

---

Cross Street	Arterial Class	Flow Speed	Running Time	Signal Delay	Travel Time (s)	Dist (mi)	Arterial Speed	Arterial LOS
Bird Road	II	40	22.0	73.4	95.4	0.19	7.2	F
	II	35	14.5	3.3	17.8	0.12	23.4	C
Total	II		36.5	76.7	113.2	0.31	9.8	F

## Arterial Level of Service

---

### Arterial Level of Service: EB Bird Road

---

Cross Street	Arterial Class	Flow Speed	Running Time	Signal Delay	Travel Time (s)	Dist (mi)	Arterial Speed	Arterial LOS
LeJeune Rd	III	35	16.6	41.3	57.9	0.13	8.1	F
Ponce de Leon Blvd	III	35	26.3	8.4	34.7	0.22	22.7	C
Total	III		42.9	49.7	92.6	0.35	13.6	E

---

### Arterial Level of Service: WB Bird Road

---

Cross Street	Arterial Class	Flow Speed	Running Time	Signal Delay	Travel Time (s)	Dist (mi)	Arterial Speed	Arterial LOS
Ponce de Leon Blvd	III	35	18.6	44.2	62.8	0.15	8.3	F
LeJeune Rd	III	35	26.3	43.3	69.6	0.22	11.3	E
Total	III		44.9	87.5	132.4	0.36	9.9	F

## Arterial Level of Service

---

### Arterial Level of Service: WB Altara Ave

---

Cross Street	Arterial Class	Flow Speed	Running Time	Signal Delay	Travel Time (s)	Dist (mi)	Arterial Speed	Arterial LOS
LeJeune Rd	III	30	27.9	0.0	27.9	0.22	28.3	B
Total	III		27.9	0.0	27.9	0.22	28.3	B

# APPENDIX L

---

## Multimodal Level-of-Service (LOS) Output Reports

## Existing Conditions

---



# ARTPLAN 2012 Conceptual Planning Analysis

## Project Information

<b>Analyst</b>	Fabio Soto	<b>Arterial Name</b>	Bird Road	<b>Study Period</b>	<b>Standard K</b>
<b>Date Prepared</b>	2/20/2020 3:05:11 PM	<b>From</b>	LeJeune Road	<b>Modal Analysis</b>	Multimodal
<b>Agency</b>	APCTE	<b>To</b>	Ponce de Leon Blvd	<b>Program</b>	ARTPLAN 2012
<b>Area Type</b>	Large Urbanized	<b>Peak Direction</b>	Eastbound	<b>Version Date</b>	12/12/2012
<b>Arterial Class</b>	1				
<b>File Name</b>	untitled.xap				
<b>User Notes</b>					

## Arterial Data

<b>K</b>	0.09	<b>PHF</b>	0.97	<b>Control Type</b>	CoordinatedActuated
<b>D</b>	0.543	<b>% Heavy Vehicles</b>	6	<b>Base Sat. Flow Rate</b>	1950

## Automobile Intersection Data

Cross Street	Cycle Length	Thru g/C	Arr. Type	INT # Dir.Lanes	% Left Turns	% Right Turns	Left Turn Lanes	Left Turn Phasing	# Left Turn Lanes	LT Storage Length	Left g/C	Right Turn Lanes
Ponce de Leon Blvd	180	0.48	4	2	11	9	Yes	ProtPerm	1	191	0.11	Yes

## Automobile Segment Data

Segment #	Length	AADT	Hourly Vol.	SEG # Dir.Lanes	Posted Speed	Free Flow Speed	Median Type	On-Street Parking	Parking Activity
1 (to Ponce de Leon Blvd)	2341	37000	1808	2	35	40	Restrictive	No	N/A

## Automobile LOS

Segment #	Thru Mvmt Flow Rate	Adj. Sat. Flow Rate	v/c	Control Delay	Int. Approach LOS	Queue Ratio	Speed (mph)	Segment LOS			
1 (to Ponce de Leon Blvd)	1491	3197	0.972	35.90	D	#	20.23	D			
<b>Arterial Length</b>	<b>0.4547</b>	<b>Weighted g/C</b>	<b>0.48</b>	<b>FFS Delay</b>	<b>41.03</b>	<b>Threshold Delay</b>	<b>0.00</b>	<b>Auto Speed</b>	<b>20.23</b>	<b>Auto LOS</b>	<b>D</b>

## Automobile Service Volumes

**Note: The maximum normally acceptable directional service volume for LOS E in Florida for this facility type and area type is 1000 veh/h/ln.**

	A	B	C	D	E
<b>Lanes</b>	<b>Hourly Volume In Peak Direction</b>				
1	**	**	640	950	980
2	**	**	1390	1890	1920
3	**	**	2190	2860	2900
4	**	**	2970	3830	3860
*	**	**	1390	1890	1920
<b>Lanes</b>	<b>Hourly Volume In Both Directions</b>				
2	**	**	1180	1750	1790
4	**	**	2560	3490	3540
6	**	**	4040	5270	5330
8	**	**	5470	7060	7120
*	**	**	2560	3490	3540
<b>Lanes</b>	<b>Annual Average Daily Traffic</b>				
2	**	**	13100	19500	19900
4	**	**	28500	38700	39300
6	**	**	44900	58600	59200
8	**	**	60800	78400	79100
*	**	**	28500	38700	39300

### Multimodal Segment Data

Segment #	Outside Lane Width	Pave Cond	Pave Shldr / Bike Lane	Side Path	Side Path Separation	Side walk	Sidewalk Roadway Separation	Sidewalk Roadway Protective Barrier	Bus Freq	Passenger Load Factor	Amenities	Bus Stop Type
1 (to Ponce de Leon Blvd)	Typical	Typical	No	No	N/A	Yes	Adjacent	No	3	0.8	Fair	Typical

### Pedestrian SubSegment Data

Segment #	% of Segment			Sidewalk			Separation			Barrier		
	1	2	3	1	2	3	1	2	3	1	2	3
1 (to Ponce de Leon Blvd)	100			Yes			Adjacent				No	

### Multimodal LOS

Link #	Bicycle Street		Bicycle Sidepath		Pedestrian			Bus					
	Score	LOS	Score	LOS	1	2	3	Score	LOS	Adj. Buses	LOS		
1 (to Ponce de Leon Blvd)	5.44	F	N/A	N/A				4.19	D	2.99	D		
	<b>Bicycle LOS</b>	<b>5.44</b>	<b>F</b>					<b>Pedestrian LOS</b>	<b>4.19</b>	<b>D</b>	<b>Bus LOS</b>	<b>2.99</b>	<b>D</b>

## MultiModal Service Volume Tables

### Bicycle

	A	B	C	D	E
<b>Lanes</b>	<b>Hourly Volume In Peak Direction</b>				
1	**	**	90	150	330
2	**	**	170	290	650
3	**	**	260	440	980
4	**	**	340	580	1300
*	**	**	170	290	650
<b>Lanes</b>	<b>Hourly Volume In Both Directions</b>				
2	**	**	160	270	600
4	**	**	310	540	1200
6	**	**	470	800	1800
8	**	**	620	1070	2390
*	**	**	310	540	1200
<b>Lanes</b>	<b>Annual Average Daily Traffic</b>				
2	**	**	1800	3000	6700
4	**	**	3500	5900	13300
6	**	**	5200	8900	19900
8	**	**	6900	11800	26600
*	**	**	3500	5900	13300

### Pedestrian

	A	B	C	D	E
<b>Lanes</b>	<b>Hourly Volume In Peak Direction</b>				
1	1000	> 1000	***	***	***
2	2000	> 2000	***	***	***
3	3000	> 3000	***	***	***
4	4000	> 4000	***	***	***
*	2000	> 2000	***	***	***
<b>Lanes</b>	<b>Hourly Volume In Both Directions</b>				
2	1850	> 1850	***	***	***
4	3690	> 3690	***	***	***
6	5530	> 5530	***	***	***
8	7370	> 7370	***	***	***
*	3690	> 3690	***	***	***
<b>Lanes</b>	<b>Annual Average Daily Traffic</b>				
2	20500	> 20500	***	***	***
4	41000	> 41000	***	***	***
6	61400	> 61400	***	***	***
8	81900	> 81900	***	***	***
*	41000	> 41000	***	***	***

### Bus

A	B	C	D	E
<b>Buses Per Hour In Peak Direction</b>				
>= 7	>= 5	>= 4	>= 3	>= 2
<b>Buses in Study Hour in Peak Direction (Daily)</b>				

$\geq 6.18$	$\geq 4.12$	$\geq 3.09$	$\geq 2.06$	$\geq 1.03$
-------------	-------------	-------------	-------------	-------------

**\* Service Volumes for the specific facility being analyzed, based on # of lanes from the intersection and segment data screens.**

**\*\* Cannot be achieved based on input data provided.**

**\*\*\* Not applicable for that level of service letter grade. See generalized tables notes for more details.**

**# Under the given conditions, left turn lane storage is highly likely to overflow. The number of directional thru lanes should be reduced accordingly.**

**## Facility weighted g/C exceeds normally acceptable upper range (0.5); verify that g/C inputs are correct.**

**### Intersection capacity (ies) are exceeded for the full hour; an operational level analysis tool is more appropriate for this situation.**

# ARTPLAN 2012 Conceptual Planning Analysis

## Project Information

<b>Analyst</b>	Fabio Soto	<b>Arterial Name</b>	Ponce de Leon Blvd	<b>Study Period</b>	<b>Standard K</b>
<b>Date Prepared</b>	2/21/2020 11:51:08 AM	<b>From</b>	Bird Road	<b>Modal Analysis</b>	Multimodal
<b>Agency</b>	APCTE	<b>To</b>	San Lorenzo Ave	<b>Program</b>	ARTPLAN 2012
<b>Area Type</b>	Large Urbanized	<b>Peak Direction</b>	Southbound	<b>Version Date</b>	12/12/2012
<b>Arterial Class</b>	1				
<b>File Name</b>	untitled.xap				
<b>User Notes</b>					

## Arterial Data

<b>K</b>	0.09	<b>PHF</b>	0.97	<b>Control Type</b>	CoordinatedActuated
<b>D</b>	0.543	<b>% Heavy Vehicles</b>	12.1	<b>Base Sat. Flow Rate</b>	1950

## Automobile Intersection Data

Cross Street	Cycle Length	Thru g/C	Arr. Type	INT # Dir.Lanes	% Left Turns	% Right Turns	Left Turn Lanes	Left Turn Phasing	# Left Turn Lanes	LT Storage Length	Left g/C	Right Turn Lanes
San Lorenzo Ave	180	0.2	4	2	20	13	Yes	ProtPerm	1	75	0.05	Yes

## Automobile Segment Data

Segment #	Length	AADT	Hourly Vol.	SEG # Dir.Lanes	Posted Speed	Free Flow Speed	Median Type	On-Street Parking	Parking Activity
1 (to San Lorenzo Ave)	1600	12300	601	2	30	35	Restrictive	Yes	Medium

## Automobile LOS

Segment #	Thru Mvmt Flow Rate	Adj. Sat. Flow Rate	v/c	Control Delay	Int. Approach LOS	Queue Ratio	Speed (mph)	Segment LOS			
1 (to San Lorenzo Ave)	415	2598	0.554	62.53	E	#	11.47	F			
<b>Arterial Length</b>	<b>0.3144</b>	<b>Weighted g/C</b>	<b>0.20</b>	<b>FFS Delay</b>	<b>67.50</b>	<b>Threshold Delay</b>	<b>35.79</b>	<b>Auto Speed</b>	<b>11.47</b>	<b>Auto LOS</b>	<b>F</b>

## Automobile Service Volumes

**Note: The maximum normally acceptable directional service volume for LOS E in Florida for this facility type and area type is 1000 veh/h/ln.**

	A	B	C	D	E
<b>Lanes</b>	<b>Hourly Volume In Peak Direction</b>				
1	**	**	**	**	**
2	**	**	**	**	**
3	**	**	**	**	**
4	**	**	**	**	**
*	**	**	**	**	**
<b>Lanes</b>	<b>Hourly Volume In Both Directions</b>				
2	**	**	**	**	**
4	**	**	**	**	**
6	**	**	**	**	**
8	**	**	**	**	**
*	**	**	**	**	**
<b>Lanes</b>	<b>Annual Average Daily Traffic</b>				
2	**	**	**	**	**
4	**	**	**	**	**
6	**	**	**	**	**
8	**	**	**	**	**
*	**	**	**	**	**

### Multimodal Segment Data

Segment #	Outside Lane Width	Pave Cond	Pave Shldr / Bike Lane	Side Path	Side Path Separation	Side walk	Sidewalk Roadway Separation	Sidewalk Roadway Protective Barrier	Bus Freq	Passenger Load Factor	Amenities	Bus Stop Type
1 (to San Lorenzo Ave)	Typical	Typical	No	No	N/A	Yes	Typical	No	4	0.8	Fair	Typical

### Pedestrian SubSegment Data

Segment #	% of Segment			Sidewalk			Separation			Barrier		
	1	2	3	1	2	3	1	2	3	1	2	3
1 (to San Lorenzo Ave)	100			Yes			Typical				No	

### Multimodal LOS

Link #	Bicycle Street		Bicycle Sidepath		Pedestrian			Bus						
	Score	LOS	Score	LOS	1	2	3	Score	LOS	Adj. Buses	LOS			
1 (to San Lorenzo Ave)	6.61	F	N/A	N/A				1.88	A	3.82	C			
	<b>Bicycle LOS</b>	<b>6.61</b>	<b>F</b>					<b>Pedestrian LOS</b>	<b>1.88</b>	<b>A</b>		<b>Bus LOS</b>	<b>3.82</b>	<b>C</b>



## MultiModal Service Volume Tables

### Bicycle

	A	B	C	D	E
<b>Lanes</b>	<b>Hourly Volume In Peak Direction</b>				
1	**	**	**	**	60
2	**	**	**	110	130
3	**	**	**	**	210
4	**	**	**	**	280
*	**	**	**	110	130
<b>Lanes</b>	<b>Hourly Volume In Both Directions</b>				
2	**	**	**	**	120
4	**	**	**	200	240
6	**	**	**	**	380
8	**	**	**	**	510
*	**	**	**	200	240
<b>Lanes</b>	<b>Annual Average Daily Traffic</b>				
2	**	**	**	**	1300
4	**	**	**	2300	2700
6	**	**	**	**	4200
8	**	**	**	**	5700
*	**	**	**	2300	2700

### Pedestrian

	A	B	C	D	E
<b>Lanes</b>	<b>Hourly Volume In Peak Direction</b>				
1	1000	> 1000	***	***	***
2	2000	> 2000	***	***	***
3	3000	> 3000	***	***	***
4	4000	> 4000	***	***	***
*	2000	> 2000	***	***	***
<b>Lanes</b>	<b>Hourly Volume In Both Directions</b>				
2	1850	> 1850	***	***	***
4	3690	> 3690	***	***	***
6	5530	> 5530	***	***	***
8	7370	> 7370	***	***	***
*	3690	> 3690	***	***	***
<b>Lanes</b>	<b>Annual Average Daily Traffic</b>				
2	20500	> 20500	***	***	***
4	41000	> 41000	***	***	***
6	61400	> 61400	***	***	***
8	81900	> 81900	***	***	***
*	41000	> 41000	***	***	***

### Bus

A	B	C	D	E
<b>Buses Per Hour In Peak Direction</b>				
>= 6	>= 4	>= 3	>= 2	>= 1
<b>Buses in Study Hour in Peak Direction (Daily)</b>				

$\geq 5.43$	$\geq 3.62$	$\geq 2.72$	$\geq 1.81$	$\geq 0.91$
-------------	-------------	-------------	-------------	-------------

**\* Service Volumes for the specific facility being analyzed, based on # of lanes from the intersection and segment data screens.**

**\*\* Cannot be achieved based on input data provided.**

**\*\*\* Not applicable for that level of service letter grade. See generalized tables notes for more details.**

**# Under the given conditions, left turn lane storage is highly likely to overflow. The number of directional thru lanes should be reduced accordingly.**

**## Facility weighted g/C exceeds normally acceptable upper range (0.5); verify that g/C inputs are correct.**

**### Intersection capacity (ies) are exceeded for the full hour; an operational level analysis tool is more appropriate for this situation.**

# ARTPLAN 2012 Conceptual Planning Analysis

## Project Information

<b>Analyst</b>	Fabio Soto	<b>Arterial Name</b>	Le Jeune Road	<b>Study Period</b>	<b>Standard K</b>
<b>Date Prepared</b>	2/20/2020 3:05:11 PM	<b>From</b>	Bird Road	<b>Modal Analysis</b>	Multimodal
<b>Agency</b>	APCTE	<b>To</b>	Altara Avenue	<b>Program</b>	ARTPLAN 2012
<b>Area Type</b>	Large Urbanized	<b>Peak Direction</b>	Southbound	<b>Version Date</b>	12/12/2012
<b>Arterial Class</b>	1				
<b>File Name</b>	G:\My Drive\0. APCTE\Coral Gables\Multimodal Analysis\LeJeune Road from Bird Road to Altara Avenue.xap				
<b>User Notes</b>					

## Arterial Data

<b>K</b>	0.09	<b>PHF</b>	0.97	<b>Control Type</b>	CoordinatedActuated
<b>D</b>	0.543	<b>% Heavy Vehicles</b>	2.9	<b>Base Sat. Flow Rate</b>	1950

## Automobile Intersection Data

Cross Street	Cycle Length	Thru g/C	Arr. Type	INT # Dir.Lanes	% Left Turns	% Right Turns	Left Turn Lanes	Left Turn Phasing	# Left Turn Lanes	LT Storage Length	Left g/C	Right Turn Lanes
Altara Avenue	180	0.46	4	2	15	5	Yes	ProtPerm	1	270	0.06	No

## Automobile Segment Data

Segment #	Length	AADT	Hourly Vol.	SEG # Dir.Lanes	Posted Speed	Free Flow Speed	Median Type	On-Street Parking	Parking Activity
1 (to Altara Avenue)	1200	23500	1148	2	40	45	None	No	N/A

## Automobile LOS

Segment #	Thru Mvmt Flow Rate	Adj. Sat. Flow Rate	v/c	Control Delay	Int. Approach LOS	Queue Ratio	Speed (mph)	Segment LOS			
1 (to Altara Avenue)	1006	3340	0.589	25.80	C	#	18.26	D			
<b>Arterial Length</b>	<b>0.2386</b>	<b>Weighted g/C</b>	<b>0.46</b>	<b>FFS Delay</b>	<b>28.86</b>	<b>Threshold Delay</b>	<b>0.00</b>	<b>Auto Speed</b>	<b>18.26</b>	<b>Auto LOS</b>	<b>D</b>

## Automobile Service Volumes

**Note: The maximum normally acceptable directional service volume for LOS E in Florida for this facility type and area type is 1000 veh/h/ln.**

	A	B	C	D	E
<b>Lanes</b>	<b>Hourly Volume In Peak Direction</b>				
1	**	**	**	480	760
2	**	**	**	1100	1660
3	**	**	**	1730	2570
4	**	**	**	2370	3480
*	**	**	**	1100	1660
<b>Lanes</b>	<b>Hourly Volume In Both Directions</b>				
2	**	**	**	890	1400
4	**	**	**	2030	3060
6	**	**	**	3190	4740
8	**	**	**	4370	6410
*	**	**	**	2030	3060
<b>Lanes</b>	<b>Annual Average Daily Traffic</b>				
2	**	**	**	9900	15600
4	**	**	**	22600	34000
6	**	**	**	35500	52600
8	**	**	**	48500	71300
*	**	**	**	22600	34000

### Multimodal Segment Data

Segment #	Outside Lane Width	Pave Cond	Pave Shldr / Bike Lane	Side Path	Side Path Separation	Side walk	Sidewalk Roadway Separation	Sidewalk Roadway Protective Barrier	Bus Freq	Passenger Load Factor	Amenities	Bus Stop Type
1 (to Altara Avenue)	Typical	Typical	No	No	N/A	Yes	Adjacent	No	4	0.8	Fair	Typical

### Pedestrian SubSegment Data

Segment #	% of Segment			Sidewalk			Separation			Barrier		
	1	2	3	1	2	3	1	2	3	1	2	3
1 (to Altara Avenue)	100			Yes			Adjacent				No	

### Multimodal LOS

Link #	Bicycle Street		Bicycle Sidepath		Pedestrian			Bus			
	Score	LOS	Score	LOS	1	2	3	Score	LOS	Adj. Buses	LOS
1 (to Altara Avenue)	4.56	E	N/A	N/A				3.54	D	3.42	C
	<b>Bicycle LOS</b>	<b>4.56</b>	<b>E</b>					<b>Pedestrian LOS</b>	<b>3.54</b>	<b>D</b>	
									<b>Bus LOS</b>	<b>3.42</b>	<b>C</b>

## MultiModal Service Volume Tables

### Bicycle

	A	B	C	D	E
<b>Lanes</b>	<b>Hourly Volume In Peak Direction</b>				
1	80	120	140	340	1000
2	100	160	300	700	2000
3	**	160	440	1060	3000
4	**	**	580	1400	4000
*	100	160	300	700	2000
<b>Lanes</b>	<b>Hourly Volume In Both Directions</b>				
2	140	230	260	630	1850
4	190	280	540	1280	3690
6	**	280	810	1950	5530
8	**	**	1070	2580	7370
*	190	280	540	1280	3690
<b>Lanes</b>	<b>Annual Average Daily Traffic</b>				
2	1600	2500	2900	7000	20500
4	2100	3200	6000	14200	41000
6	**	3200	9000	21700	61400
8	**	**	11900	28700	81900
*	2100	3200	6000	14200	41000

### Pedestrian

	A	B	C	D	E
<b>Lanes</b>	<b>Hourly Volume In Peak Direction</b>				
1	1000	> 1000	***	***	***
2	2000	> 2000	***	***	***
3	3000	> 3000	***	***	***
4	4000	> 4000	***	***	***
*	2000	> 2000	***	***	***
<b>Lanes</b>	<b>Hourly Volume In Both Directions</b>				
2	1850	> 1850	***	***	***
4	3690	> 3690	***	***	***
6	5530	> 5530	***	***	***
8	7370	> 7370	***	***	***
*	3690	> 3690	***	***	***
<b>Lanes</b>	<b>Annual Average Daily Traffic</b>				
2	20500	> 20500	***	***	***
4	41000	> 41000	***	***	***
6	61400	> 61400	***	***	***
8	81900	> 81900	***	***	***
*	41000	> 41000	***	***	***

### Bus

A	B	C	D	E
<b>Buses Per Hour In Peak Direction</b>				
>= 8	>= 5	>= 4	>= 3	>= 2
<b>Buses in Study Hour in Peak Direction (Daily)</b>				

$\geq 7.37$	$\geq 4.92$	$\geq 3.69$	$\geq 2.46$	$\geq 1.23$
-------------	-------------	-------------	-------------	-------------

**\* Service Volumes for the specific facility being analyzed, based on # of lanes from the intersection and segment data screens.**

**\*\* Cannot be achieved based on input data provided.**

**\*\*\* Not applicable for that level of service letter grade. See generalized tables notes for more details.**

**# Under the given conditions, left turn lane storage is highly likely to overflow. The number of directional thru lanes should be reduced accordingly.**

**## Facility weighted g/C exceeds normally acceptable upper range (0.5); verify that g/C inputs are correct.**

**### Intersection capacity (ies) are exceeded for the full hour; an operational level analysis tool is more appropriate for this situation.**

## Future Conditions

---



# ARTPLAN 2012 Conceptual Planning Analysis

## Project Information

<b>Analyst</b>	Fabio Soto	<b>Arterial Name</b>	Bird Road	<b>Study Period</b>	<b>Standard K</b>
<b>Date Prepared</b>	2/20/2020 3:05:11 PM	<b>From</b>	LeJeune Road	<b>Modal Analysis</b>	Multimodal
<b>Agency</b>	APCTE	<b>To</b>	Ponce de Leon Blvd	<b>Program</b>	ARTPLAN 2012
<b>Area Type</b>	Large Urbanized	<b>Peak Direction</b>	Eastbound	<b>Version Date</b>	12/12/2012
<b>Arterial Class</b>	1				
<b>File Name</b>	G:\My Drive\0. APCTE\Coral Gables\Multimodal Analysis\Bird Road from LeJeune Rd to Ponce de Leon Blvd - Future Conditions.xap				
<b>User Notes</b>					

## Arterial Data

<b>K</b>	0.09	<b>PHF</b>	0.97	<b>Control Type</b>	CoordinatedActuated
<b>D</b>	0.543	<b>% Heavy Vehicles</b>	6	<b>Base Sat. Flow Rate</b>	1950

## Automobile Intersection Data

Cross Street	Cycle Length	Thru g/C	Arr. Type	INT # Dir.Lanes	% Left Turns	% Right Turns	Left Turn Lanes	Left Turn Phasing	# Left Turn Lanes	LT Storage Length	Left g/C	Right Turn Lanes
Ponce de Leon Blvd	180	0.48	4	2	11	9	Yes	ProtPerm	1	191	0.11	Yes

## Automobile Segment Data

Segment #	Length	AADT	Hourly Vol.	SEG # Dir.Lanes	Posted Speed	Free Flow Speed	Median Type	On-Street Parking	Parking Activity
1 (to Ponce de Leon Blvd)	2341	37744	1845	2	35	40	Restrictive	No	N/A

## Automobile LOS

Segment #	Thru Mvmt Flow Rate	Adj. Sat. Flow Rate	v/c	Control Delay	Int. Approach LOS	Queue Ratio	Speed (mph)	Segment LOS			
1 (to Ponce de Leon Blvd)	1522	3197	0.992	38.00	D	#	19.69	D			
<b>Arterial Length</b>	<b>0.4547</b>	<b>Weighted g/C</b>	<b>0.48</b>	<b>FFS Delay</b>	<b>43.22</b>	<b>Threshold Delay</b>	<b>0.00</b>	<b>Auto Speed</b>	<b>19.69</b>	<b>Auto LOS</b>	<b>D</b>

## Automobile Service Volumes

**Note: The maximum normally acceptable directional service volume for LOS E in Florida for this facility type and area type is 1000 veh/h/ln.**

	A	B	C	D	E
<b>Lanes</b>	<b>Hourly Volume In Peak Direction</b>				
1	**	**	640	950	980
2	**	**	1390	1890	1920
3	**	**	2190	2860	2900
4	**	**	2970	3830	3860
*	**	**	1390	1890	1920
<b>Lanes</b>	<b>Hourly Volume In Both Directions</b>				
2	**	**	1180	1750	1790
4	**	**	2560	3490	3540
6	**	**	4040	5270	5330
8	**	**	5470	7060	7120
*	**	**	2560	3490	3540
<b>Lanes</b>	<b>Annual Average Daily Traffic</b>				
2	**	**	13100	19500	19900
4	**	**	28500	38700	39300
6	**	**	44900	58600	59200
8	**	**	60800	78400	79100
*	**	**	28500	38700	39300

### Multimodal Segment Data

Segment #	Outside Lane Width	Pave Cond	Pave Shldr / Bike Lane	Side Path	Side Path Separation	Side walk	Sidewalk Roadway Separation	Sidewalk Roadway Protective Barrier	Bus Freq	Passenger Load Factor	Amenities	Bus Stop Type
1 (to Ponce de Leon Blvd)	Typical	Typical	No	No	N/A	Yes	Adjacent	No	3	0.8	Fair	Typical

### Pedestrian SubSegment Data

Segment #	% of Segment			Sidewalk			Separation			Barrier		
	1	2	3	1	2	3	1	2	3	1	2	3
1 (to Ponce de Leon Blvd)	100			Yes			Adjacent				No	

### Multimodal LOS

Link #	Bicycle Street		Bicycle Sidepath		Pedestrian			Bus					
	Score	LOS	Score	LOS	1	2	3	Score	LOS	Adj. Buses	LOS		
1 (to Ponce de Leon Blvd)	5.45	F	N/A	N/A				4.23	D	2.99	D		
	<b>Bicycle LOS</b>	<b>5.45</b>	<b>F</b>					<b>Pedestrian LOS</b>	<b>4.23</b>	<b>D</b>	<b>Bus LOS</b>	<b>2.99</b>	<b>D</b>

## MultiModal Service Volume Tables

### Bicycle

	A	B	C	D	E
<b>Lanes</b>	<b>Hourly Volume In Peak Direction</b>				
1	**	**	90	150	330
2	**	**	170	290	650
3	**	**	260	440	980
4	**	**	340	580	1300
*	**	**	170	290	650
<b>Lanes</b>	<b>Hourly Volume In Both Directions</b>				
2	**	**	160	270	600
4	**	**	310	540	1200
6	**	**	470	800	1800
8	**	**	620	1070	2390
*	**	**	310	540	1200
<b>Lanes</b>	<b>Annual Average Daily Traffic</b>				
2	**	**	1800	3000	6700
4	**	**	3500	5900	13300
6	**	**	5200	8900	19900
8	**	**	6900	11800	26600
*	**	**	3500	5900	13300

### Pedestrian

	A	B	C	D	E
<b>Lanes</b>	<b>Hourly Volume In Peak Direction</b>				
1	1000	> 1000	***	***	***
2	2000	> 2000	***	***	***
3	3000	> 3000	***	***	***
4	4000	> 4000	***	***	***
*	2000	> 2000	***	***	***
<b>Lanes</b>	<b>Hourly Volume In Both Directions</b>				
2	1850	> 1850	***	***	***
4	3690	> 3690	***	***	***
6	5530	> 5530	***	***	***
8	7370	> 7370	***	***	***
*	3690	> 3690	***	***	***
<b>Lanes</b>	<b>Annual Average Daily Traffic</b>				
2	20500	> 20500	***	***	***
4	41000	> 41000	***	***	***
6	61400	> 61400	***	***	***
8	81900	> 81900	***	***	***
*	41000	> 41000	***	***	***

### Bus

A	B	C	D	E
<b>Buses Per Hour In Peak Direction</b>				
>= 7	>= 5	>= 4	>= 3	>= 2
<b>Buses in Study Hour in Peak Direction (Daily)</b>				

$\geq 6.18$	$\geq 4.12$	$\geq 3.09$	$\geq 2.06$	$\geq 1.03$
-------------	-------------	-------------	-------------	-------------

**\* Service Volumes for the specific facility being analyzed, based on # of lanes from the intersection and segment data screens.**

**\*\* Cannot be achieved based on input data provided.**

**\*\*\* Not applicable for that level of service letter grade. See generalized tables notes for more details.**

**# Under the given conditions, left turn lane storage is highly likely to overflow. The number of directional thru lanes should be reduced accordingly.**

**## Facility weighted g/C exceeds normally acceptable upper range (0.5); verify that g/C inputs are correct.**

**### Intersection capacity (ies) are exceeded for the full hour; an operational level analysis tool is more appropriate for this situation.**

# ARTPLAN 2012 Conceptual Planning Analysis

## Project Information

<b>Analyst</b>	Fabio Soto	<b>Arterial Name</b>	Ponce de Leon Blvd	<b>Study Period</b>	<b>Standard K</b>
<b>Date Prepared</b>	2/21/2020 11:51:08 AM	<b>From</b>	Bird Road	<b>Modal Analysis</b>	Multimodal
<b>Agency</b>	APCTE	<b>To</b>	San Lorenzo Ave	<b>Program</b>	ARTPLAN 2012
<b>Area Type</b>	Large Urbanized	<b>Peak Direction</b>	Southbound	<b>Version Date</b>	12/12/2012
<b>Arterial Class</b>	1				
<b>File Name</b>	G:\My Drive\0. APCTE\Coral Gables\Multimodal Analysis\Ponce de Leon from Bird Road to San Lorenzo Avenue - Future Conditions.xap				
<b>User Notes</b>					

## Arterial Data

<b>K</b>	0.09	<b>PHF</b>	0.97	<b>Control Type</b>	CoordinatedActuated
<b>D</b>	0.543	<b>% Heavy Vehicles</b>	12.1	<b>Base Sat. Flow Rate</b>	1950

## Automobile Intersection Data

Cross Street	Cycle Length	Thru g/C	Arr. Type	INT # Dir.Lanes	% Left Turns	% Right Turns	Left Turn Lanes	Left Turn Phasing	# Left Turn Lanes	LT Storage Length	Left g/C	Right Turn Lanes
San Lorenzo Ave	180	0.2	4	2	20	13	Yes	ProtPerm	1	75	0.05	Yes

## Automobile Segment Data

Segment #	Length	AADT	Hourly Vol.	SEG # Dir.Lanes	Posted Speed	Free Flow Speed	Median Type	On-Street Parking	Parking Activity
1 (to San Lorenzo Ave)	1600	12547	613	2	30	35	Restrictive	Yes	Medium

## Automobile LOS

Segment #	Thru Mvmt Flow Rate	Adj. Sat. Flow Rate	v/c	Control Delay	Int. Approach LOS	Queue Ratio	Speed (mph)	Segment LOS			
1 (to San Lorenzo Ave)	423	2595	0.527	61.93	E	#	11.54	F			
<b>Arterial Length</b>	<b>0.3144</b>	<b>Weighted g/C</b>	<b>0.20</b>	<b>FFS Delay</b>	<b>66.92</b>	<b>Threshold Delay</b>	<b>35.21</b>	<b>Auto Speed</b>	<b>11.54</b>	<b>Auto LOS</b>	<b>F</b>

## Automobile Service Volumes

**Note: The maximum normally acceptable directional service volume for LOS E in Florida for this facility type and area type is 1000 veh/h/ln.**

	A	B	C	D	E
<b>Lanes</b>	<b>Hourly Volume In Peak Direction</b>				
1	**	**	**	**	**
2	**	**	**	**	**
3	**	**	**	**	**
4	**	**	**	**	**
*	**	**	**	**	**
<b>Lanes</b>	<b>Hourly Volume In Both Directions</b>				
2	**	**	**	**	**
4	**	**	**	**	**
6	**	**	**	**	**
8	**	**	**	**	**
*	**	**	**	**	**
<b>Lanes</b>	<b>Annual Average Daily Traffic</b>				
2	**	**	**	**	**
4	**	**	**	**	**
6	**	**	**	**	**
8	**	**	**	**	**
*	**	**	**	**	**

### Multimodal Segment Data

Segment #	Outside Lane Width	Pave Cond	Pave Shldr / Bike Lane	Side Path	Side Path Separation	Side walk	Sidewalk Roadway Separation	Sidewalk Roadway Protective Barrier	Bus Freq	Passenger Load Factor	Amenities	Bus Stop Type
1 (to San Lorenzo Ave)	Typical	Typical	No	No	N/A	Yes	Typical	No	4	0.8	Fair	Typical

### Pedestrian SubSegment Data

Segment #	% of Segment			Sidewalk			Separation			Barrier		
	1	2	3	1	2	3	1	2	3	1	2	3
1 (to San Lorenzo Ave)	100			Yes			Typical				No	

### Multimodal LOS

Link #	Bicycle Street		Bicycle Sidepath		Pedestrian			Bus						
	Score	LOS	Score	LOS	1	2	3	Score	LOS	Adj. Buses	LOS			
1 (to San Lorenzo Ave)	6.62	F	N/A	N/A				1.89	A	3.82	C			
	<b>Bicycle LOS</b>	<b>6.62</b>	<b>F</b>					<b>Pedestrian LOS</b>	<b>1.89</b>	<b>A</b>		<b>Bus LOS</b>	<b>3.82</b>	<b>C</b>



## MultiModal Service Volume Tables

### Bicycle

	A	B	C	D	E
<b>Lanes</b>	<b>Hourly Volume In Peak Direction</b>				
1	**	**	**	**	60
2	**	**	**	110	130
3	**	**	**	**	210
4	**	**	**	**	280
*	**	**	**	110	130
<b>Lanes</b>	<b>Hourly Volume In Both Directions</b>				
2	**	**	**	**	120
4	**	**	**	200	240
6	**	**	**	**	380
8	**	**	**	**	510
*	**	**	**	200	240
<b>Lanes</b>	<b>Annual Average Daily Traffic</b>				
2	**	**	**	**	1300
4	**	**	**	2300	2700
6	**	**	**	**	4200
8	**	**	**	**	5700
*	**	**	**	2300	2700

### Pedestrian

	A	B	C	D	E
<b>Lanes</b>	<b>Hourly Volume In Peak Direction</b>				
1	1000	> 1000	***	***	***
2	2000	> 2000	***	***	***
3	3000	> 3000	***	***	***
4	4000	> 4000	***	***	***
*	2000	> 2000	***	***	***
<b>Lanes</b>	<b>Hourly Volume In Both Directions</b>				
2	1850	> 1850	***	***	***
4	3690	> 3690	***	***	***
6	5530	> 5530	***	***	***
8	7370	> 7370	***	***	***
*	3690	> 3690	***	***	***
<b>Lanes</b>	<b>Annual Average Daily Traffic</b>				
2	20500	> 20500	***	***	***
4	41000	> 41000	***	***	***
6	61400	> 61400	***	***	***
8	81900	> 81900	***	***	***
*	41000	> 41000	***	***	***

### Bus

A	B	C	D	E
<b>Buses Per Hour In Peak Direction</b>				
>= 6	>= 4	>= 3	>= 2	>= 1
<b>Buses in Study Hour in Peak Direction (Daily)</b>				

$\geq 5.43$	$\geq 3.62$	$\geq 2.72$	$\geq 1.81$	$\geq 0.91$
-------------	-------------	-------------	-------------	-------------

**\* Service Volumes for the specific facility being analyzed, based on # of lanes from the intersection and segment data screens.**

**\*\* Cannot be achieved based on input data provided.**

**\*\*\* Not applicable for that level of service letter grade. See generalized tables notes for more details.**

**# Under the given conditions, left turn lane storage is highly likely to overflow. The number of directional thru lanes should be reduced accordingly.**

**## Facility weighted g/C exceeds normally acceptable upper range (0.5); verify that g/C inputs are correct.**

**### Intersection capacity (ies) are exceeded for the full hour; an operational level analysis tool is more appropriate for this situation.**

# ARTPLAN 2012 Conceptual Planning Analysis

## Project Information

<b>Analyst</b>	Fabio Soto	<b>Arterial Name</b>	Le Jeune Road	<b>Study Period</b>	<b>Standard K</b>
<b>Date Prepared</b>	2/20/2020 3:05:11 PM	<b>From</b>	Bird Road	<b>Modal Analysis</b>	Multimodal
<b>Agency</b>	APCTE	<b>To</b>	Altara Avenue	<b>Program</b>	ARTPLAN 2012
<b>Area Type</b>	Large Urbanized	<b>Peak Direction</b>	Southbound	<b>Version Date</b>	12/12/2012
<b>Arterial Class</b>	1				
<b>File Name</b>	G:\My Drive\0. APCTE\Coral Gables\Multimodal Analysis\LeJeune Road from Bird Road to Altara Avenue - Future Conditions.xap				
<b>User Notes</b>					

## Arterial Data

<b>K</b>	0.09	<b>PHF</b>	0.97	<b>Control Type</b>	CoordinatedActuated
<b>D</b>	0.543	<b>% Heavy Vehicles</b>	2.9	<b>Base Sat. Flow Rate</b>	1950

## Automobile Intersection Data

Cross Street	Cycle Length	Thru g/C	Arr. Type	INT # Dir.Lanes	% Left Turns	% Right Turns	Left Turn Lanes	Left Turn Phasing	# Left Turn Lanes	LT Storage Length	Left g/C	Right Turn Lanes
Altara Avenue	180	0.46	4	2	15	5	Yes	ProtPerm	1	270	0.06	No

## Automobile Segment Data

Segment #	Length	AADT	Hourly Vol.	SEG # Dir.Lanes	Posted Speed	Free Flow Speed	Median Type	On-Street Parking	Parking Activity
1 (to Altara Avenue)	1200	23972	1172	2	40	45	None	No	N/A

## Automobile LOS

Segment #	Thru Mvmt Flow Rate	Adj. Sat. Flow Rate	v/c	Control Delay	Int. Approach LOS	Queue Ratio	Speed (mph)	Segment LOS			
1 (to Altara Avenue)	1027	3343	0.595	25.93	C	#	18.20	D			
<b>Arterial Length</b>	<b>0.2386</b>	<b>Weighted g/C</b>	<b>0.46</b>	<b>FFS Delay</b>	<b>29.01</b>	<b>Threshold Delay</b>	<b>0.00</b>	<b>Auto Speed</b>	<b>18.20</b>	<b>Auto LOS</b>	<b>D</b>

## Automobile Service Volumes

**Note: The maximum normally acceptable directional service volume for LOS E in Florida for this facility type and area type is 1000 veh/h/ln.**

	A	B	C	D	E
<b>Lanes</b>	<b>Hourly Volume In Peak Direction</b>				
1	**	**	**	480	760
2	**	**	**	1100	1660
3	**	**	**	1730	2570
4	**	**	**	2370	3480
*	**	**	**	1100	1660
<b>Lanes</b>	<b>Hourly Volume In Both Directions</b>				
2	**	**	**	890	1400
4	**	**	**	2030	3060
6	**	**	**	3190	4740
8	**	**	**	4370	6410
*	**	**	**	2030	3060
<b>Lanes</b>	<b>Annual Average Daily Traffic</b>				
2	**	**	**	9900	15600
4	**	**	**	22600	34000
6	**	**	**	35500	52600
8	**	**	**	48500	71300
*	**	**	**	22600	34000

### Multimodal Segment Data

Segment #	Outside Lane Width	Pave Cond	Pave Shldr / Bike Lane	Side Path	Side Path Separation	Side walk	Sidewalk Roadway Separation	Sidewalk Roadway Protective Barrier	Bus Freq	Passenger Load Factor	Amenities	Bus Stop Type
1 (to Altara Avenue)	Typical	Typical	No	No	N/A	Yes	Adjacent	No	4	0.8	Fair	Typical

### Pedestrian SubSegment Data

Segment #	% of Segment			Sidewalk			Separation			Barrier		
	1	2	3	1	2	3	1	2	3	1	2	3
1 (to Altara Avenue)	100			Yes			Adjacent				No	

### Multimodal LOS

Link #	Bicycle Street		Bicycle Sidepath		Pedestrian			Bus						
	Score	LOS	Score	LOS	1	2	3	Score	LOS	Adj. Buses	LOS			
1 (to Altara Avenue)	4.57	E	N/A	N/A				3.57	D	3.42	C			
	<b>Bicycle LOS</b>	<b>4.57</b>	<b>E</b>					<b>Pedestrian LOS</b>	<b>3.57</b>	<b>D</b>		<b>Bus LOS</b>	<b>3.42</b>	<b>C</b>

## MultiModal Service Volume Tables

### Bicycle

	A	B	C	D	E
<b>Lanes</b>	<b>Hourly Volume In Peak Direction</b>				
1	80	120	140	340	1000
2	100	160	300	700	2000
3	**	160	440	1060	3000
4	**	**	580	1400	4000
*	100	160	300	700	2000
<b>Lanes</b>	<b>Hourly Volume In Both Directions</b>				
2	140	230	260	630	1850
4	190	280	540	1280	3690
6	**	280	810	1950	5530
8	**	**	1070	2580	7370
*	190	280	540	1280	3690
<b>Lanes</b>	<b>Annual Average Daily Traffic</b>				
2	1600	2500	2900	7000	20500
4	2100	3200	6000	14200	41000
6	**	3200	9000	21700	61400
8	**	**	11900	28700	81900
*	2100	3200	6000	14200	41000

### Pedestrian

	A	B	C	D	E
<b>Lanes</b>	<b>Hourly Volume In Peak Direction</b>				
1	1000	> 1000	***	***	***
2	2000	> 2000	***	***	***
3	3000	> 3000	***	***	***
4	4000	> 4000	***	***	***
*	2000	> 2000	***	***	***
<b>Lanes</b>	<b>Hourly Volume In Both Directions</b>				
2	1850	> 1850	***	***	***
4	3690	> 3690	***	***	***
6	5530	> 5530	***	***	***
8	7370	> 7370	***	***	***
*	3690	> 3690	***	***	***
<b>Lanes</b>	<b>Annual Average Daily Traffic</b>				
2	20500	> 20500	***	***	***
4	41000	> 41000	***	***	***
6	61400	> 61400	***	***	***
8	81900	> 81900	***	***	***
*	41000	> 41000	***	***	***

### Bus

A	B	C	D	E
<b>Buses Per Hour In Peak Direction</b>				
>= 8	>= 5	>= 4	>= 3	>= 2
<b>Buses in Study Hour in Peak Direction (Daily)</b>				

$\geq 7.37$	$\geq 4.92$	$\geq 3.69$	$\geq 2.46$	$\geq 1.23$
-------------	-------------	-------------	-------------	-------------

**\* Service Volumes for the specific facility being analyzed, based on # of lanes from the intersection and segment data screens.**

**\*\* Cannot be achieved based on input data provided.**

**\*\*\* Not applicable for that level of service letter grade. See generalized tables notes for more details.**

**# Under the given conditions, left turn lane storage is highly likely to overflow. The number of directional thru lanes should be reduced accordingly.**

**## Facility weighted g/C exceeds normally acceptable upper range (0.5); verify that g/C inputs are correct.**

**### Intersection capacity (ies) are exceeded for the full hour; an operational level analysis tool is more appropriate for this situation.**

# APPENDIX M

---

## Parking Generation Analysis



## ARTICLE 5 – DEVELOPMENT STANDARDS

- c. The requirement to implement the remedial plan according to the implementation schedule approved or extended by the Development Services Director; or
- d. The requirement to comply in any other material regard with all of the requirements of this subsection, including failure to comply with the recorded covenants as required herein. The materiality of any noncompliance shall be determined by the Development Services Director, in consultation with the City Attorney.

11. City Commission waiver.

- a. Standard for waivers. The City Commission may approve a waiver pursuant to this subsection B.11 upon finding that the waiver will neither (A) harm the public interest nor (B) create parking problems in the area surrounding the applicant’s project site.
- b. Requirements that may be waived. If the Director of Development Services reviews and rejects a remote parking application on the basis of any of the following requirements, then an applicant may request that the City Commission review its application for remote parking and, following a public hearing, approve a waiver of one (1) or more of these requirements, and may impose any conditions it deems necessary on such waiver:
  - i. The one-thousand (1,000) foot maximum distance between the remote parking spaces and the applicant’s project site; and
  - ii. The requirement that the remote parking be located in the CBD; and
  - iii. The requirement that the land containing the use seeking to utilize remote parking be located in the CBD.
- c. Effect of waiver. All of the remaining requirements of section 5-1408.B, that have not been waived by the City Commission, must be satisfied.

12. Appeals. The applicant may appeal any determinations made by the Development Services Director under this subsection through the process set forth in Article 3, Division 6 of the Zoning Code.

**Section 5-1409. Amount of required parking.**

A. Exemptions from required parking. Buildings that are located within the Central Business District (CBD) that have a floor-area-ratio of 1.25 or less (1.45 or less if Mediterranean bonus is used) are not required to provide off-street parking for any uses except residential units.

B. Calculation of parking requirements.

1. Required parking shall be provided for each use on a building site, according to the following table:

<i>Use</i>	<i>Minimum parking requirements</i>
<i>Residential</i>	
Detached dwellings.	One (1) parking space per unit consisting of a roofed structure, which utilizes the same materials as the principle structure and that is a garage, carport, or porte-cochere.
Duplex.	One (1) parking space per unit consisting of a roofed structure, which utilizes the same materials as the principle structure and that is a garage, carport, or porte-cochere.

## ARTICLE 5 – DEVELOPMENT STANDARDS

<i>Use</i>	<i>Minimum parking requirements</i>
Live work.	One (1) space per unit, plus one (1) space per three-hundred-and-fifty (350) square feet of work area.
Multi-family dwellings.	Efficiency and one (1) and bedroom units – 1.0 space per unit. Two (2) bedroom units – 1.75 spaces per unit. Three (3) or more bedroom units – 2.25 spaces per unit.
Single-family.	One (1) parking space consisting of a roofed structure, which utilizes the same materials as the principle structure and that is a garage, carport, or porte-cochere.
Townhouses.	Two (2) parking spaces per unit consisting of a roofed structure, which utilizes the same materials as the principle structure and that is a garage, carport, or porte-cochere.
<i>Non-residential</i>	
Adult uses.	One (1) space per two-hundred-and-fifty (250) square feet of floor area.
Alcoholic beverage sales.	One (1) space per two-hundred-and-fifty (250) square feet of floor area.
Animal grooming/boarding.	One (1) space per two-hundred-and-fifty (250) square feet of floor area.
Assisted living facilities.	One (1) space per full-time employee equivalent (FTE), plus two (2) spaces per five (5) beds.
Auto service stations.	One (1) space per two-hundred-and-fifty (250) square feet of accessory retail floor area.
Bed and breakfast.	One (1) space, plus one (1) space per sleeping room.
Camp.	One (1) space per FTE, plus one (1) space per four (4) students aged sixteen (16) years or older based on maximum capacity.
Cemeteries.	If services provided in a building, one (1) space per four (4) fixed seats plus one (1) space for each forty (40) square feet of floor area used for temporary seating.
Community center.	One (1) space per two-hundred-and-fifty (250) square feet of floor area.
Congregate care.	One (1) space per FTE, plus two (2) spaces per five (5) beds.
Day care.	Day care for children: One (1) space per one-hundred (100) square feet of floor area. Day care for adults: One (1) space per three-hundred (300) square feet of floor area.
Educational facilities.	One (1) space per student station.
Funeral homes.	One (1) space per four (4) fixed seats plus one (1) space for each forty (40) square feet of floor area used for temporary seating.
Golf or tennis grounds.	Four (4) spaces per hole (golf). Three (3) spaces per court (tennis). One (1) space per eighteen (18) linear feet of bleachers.
Group homes.	One (1) space per FTE, plus one (1) space per three (3) beds.
Heliport and helistop.	One (1) space per tie-down.

## ARTICLE 5 – DEVELOPMENT STANDARDS

<i>Use</i>	<i>Minimum parking requirements</i>
Hospitals.	Two (2) spaces per patient bed.
Indoor recreation / entertainment.	The greater of one (1) space per five (5) fixed seats or one (1) space per three-hundred (300) square feet of floor area.
Manufacturing.	One (1) space per three-hundred (300) square feet office floor area, plus one (1) space per one-thousand (1,000) square feet of all other floor area.
Marinas and marina facilities.	One (1) space per marina slip, plus one (1) space per three-hundred-and-fifty (350) square feet of floor area of marina facilities.
Medical clinic.	One (1) space per two-hundred (200) square feet of floor area, plus one (1) space per FTE.
Medical Marijuana Retail Center.	One (1) space per 150 square feet of floor area, plus one (1) space per FTE and one (1) space for every two (2) PTEs.
Mixed use or multi-use.	Parking shall be provided for each use in the mix of uses in correlation with the requirements of this table.
Nursing homes.	One (1) space per FTE, plus one (1) space per three (3) beds.
Offices.	One (1) space per three hundred (300) square feet of floor area.
Outdoor recreation / entertainment.	One (1) space per four (4) visitors during estimated peak use periods.
Outdoor retail sales, display and/or storage.	One (1) space per three hundred and fifty (350) square feet of land area delineated or put to such use.
Overnight accommodations.	One and one-eighth (1 1/8) spaces per sleeping room.
Private club.	One (1) space per two-hundred-and-fifty (250) square feet of floor area.
Private yacht basin.	Three (3) spaces per four (4) yacht slips.
Public transportation facility.	One (1) space per one hundred (100) square feet of terminal and station area.
Religious institutions.	One (1) space per five (5) fixed seats plus one (1) space per fifty (50) square feet of assembly room area without fixed seats (not including classrooms).
Research and technology uses.	One (1) space per three-hundred (300) square feet of office floor area, plus one (1) space per one thousand (1,000) square feet all other floor area.
Restaurants.	Twelve (12) spaces per one-thousand (1,000) square feet of floor area.
Restaurants, fast food.	Twelve (12) spaces per one-thousand (1,000) square feet of floor area.
Retail sales and services.	One (1) space per two-hundred-and-fifty (250) square feet of floor area.
Sales and/or leasing offices.	One (1) space per three-hundred (300) square feet of floor area.
Schools.	One (1) space per FTE, plus one (1) space per four (4) students aged sixteen (16) years or older based on maximum capacity.
Self-storage warehouses.	One (1) space per three-hundred (300) square feet of office floor area, plus one (1) space per one thousand (1,000) square feet all other floor area.
Telecommunications towers.	Zero (0) spaces.

## ARTICLE 5 – DEVELOPMENT STANDARDS

<i>Use</i>	<i>Minimum parking requirements</i>
TV / radio studios.	One (1) space per three-hundred (300) square feet of floor area, plus One (1) space per three (3) studio audience members at maximum capacity.
Utility / infrastructure Facilities.	Zero (0) spaces.
Utility substations.	Zero (0) spaces.
Vehicle sales /displays.	One (1) space per three-hundred (300) square feet of office floor area, plus one (1) space per six-hundred (600) square feet of showroom floor area, plus one (1) space per five (500) square feet of all other floor area.
Vehicle sales/displays, major.	One (1) space per three-hundred (300) square feet of office floor area, plus one (1) space per one thousand (1,000) square feet all other floor area.
Vehicle service, major.	One (1) space per three-hundred (300) square feet of office floor area, plus one (1) space per five hundred (500) square feet all other floor area
Veterinary offices.	One (1) space per two-hundred-and-fifty (250) square feet of floor area.
Wholesale / distribution / warehouse facility.	One (1) space per three-hundred (300) square feet of office floor area, plus one (1) space per one thousand (1,000) square feet all other floor area.
Post office.	One (1) space per two-hundred (200) square feet of floor area.

2. If a calculation of required parking spaces results in a fractional space, the number of required parking spaces shall be rounded up to the next whole number.

C. Alternative parking requirements. If a use is not listed in Section 5-1409(B)(1), then the off-street parking requirement shall be the same as the requirement for a functionally similar use that is listed in Section 5-1409(B)(1), as determined by the Development Review Official.

D. Loading spaces. Loading spaces shall be provided for all nonresidential or mixed use-buildings that exceed a floor area of one hundred thousand (100,000) square feet of floor area, as follows:

<i>Nonresidential Floor Area</i>	<i>Required Loading Spaces</i>
<100,000 sq. ft.	Zero (0)
100,000 sq. ft. to 199,999 sq. ft.	One (1)
200,000 sq. ft. to 299,999 sq. ft.	Two (2)
300,000 sq. ft. to 399,999 sq. ft.	Three (3)
Each additional 100,000 sq. ft. or fraction thereof	One (1) additional loading space

E. Calculation of compliance with parking requirement.

1. Excluded parking spaces. Parking spaces that meet any of the following criteria shall not be counted in determining the amount of parking provided pursuant to this Section 5-1409:

- a. Off-street parking spaces that are operated as a commercial parking lot.
- b. Off-street parking spaces that are provided for residential and overnight accommodation uses and are available only upon payment of a fee.

2. Valet parking spaces. Valet parking spaces for overnight accommodations, restaurants, and

## ARTICLE 5 – DEVELOPMENT STANDARDS

minor vehicle sales in any zoning district may comprise up to twenty-five (25%) percent of the required parking spaces for those uses.

3. Remote parking spaces. Remote parking spaces may comprise up to one-hundred (100%) percent of the required parking spaces if approved pursuant to Section 5-1408.B.
  4. Counted parking spaces. All parking and loading spaces that are provided on-site and all parking spaces that are in permitted remote off-street parking facilities count in determining the amount of parking provided pursuant to this Section 5-1408, except as provided in Section 5-1409(E)(1)-(4).
- F. Electric Vehicle Charging. Except single-family residences, duplexes, and townhouses, electric vehicle charging stations and infrastructure are required for new construction as provided below.
1. Reserved Electric Vehicle Parking. When twenty (20) or more off-street parking spaces are required, a minimum of two percent (2%) of the required off-street parking spaces shall be reserved for electric vehicle parking, and provide an electric charging station for each space, with a minimum of one (1) space reserved for electric vehicle parking, subject to the following:
    - a. The electric vehicle charging station shall have a minimum charging level of AC Level 2.
    - b. All components of the electric vehicle charging station shall be located entirely within the confines of the building and not visible from outside any portion of the structure.
    - c. All components shall be located above the minimum flood elevation.
    - d. The charging station shall contain a retraction device, coiled cord, or a place to hang cords and connectors above the ground surface.
    - e. Signage shall be posted at the charging station stating “Charging Station.” Signs shall have no greater length than eighteen (18) inches.
    - f. If a calculation of required parking spaces results in a fractional space, the number of required parking spaces shall be rounded up to the next whole number.
  2. Electric Vehicle Infrastructure Readiness. In addition to subsection F. 1. above, when twenty (20) or more off-street parking spaces are required, a minimum of three percent (3%) of the required off-street parking spaces shall have Electric Vehicle Supply Equipment infrastructure installed for the future installation of Electric Vehicle Charging Stations (“EV-Ready”), subject to the following:
    - a. Each required parking space shall include make-ready infrastructure with a minimum of 40-Amps on an independent 240-volt AC circuit for every electric vehicle Space.
    - b. If a calculation of required parking spaces results in a fractional space, the number of required parking spaces shall be rounded up to the next whole number.
  3. Electric Vehicle Infrastructure Capability. In addition to subsection F. 1. and 2. above, when twenty (20) or more off-street parking spaces are required, a minimum of fifteen percent (15%) of the required off-street parking spaces shall have listed raceway (conduit) and electrical capacity (breaker space) allocated in a local subpanel to accommodate future EVSE installations (“EV-Capable”), subject to the following:
    - a. All conduits and subpanels installed throughout the new construction shall be sized to accommodate 60A or 40A breakers for each parking space.
    - b. If a calculation of required parking spaces results in a fractional space, the number of required parking spaces shall be rounded up to the next whole number.

### Section 5-1410. Shared parking reduction standards.

- A. Intent and Purpose. The intent and purpose of this section is to recognize the synergy among different uses within a mixed use development such that peak times for parking for one use occurs at a different time from another use. Also, because mixed uses gives the opportunity for persons being able to live and work within the same building, parking requirements are reduced. It is further recognized that the reduction of excessive parking spaces can positively affect the aesthetics of the building design that meets the spirit and intent of Section 5-602 “Design Review Standards” of the Zoning Code.

## ARTICLE 5 – DEVELOPMENT STANDARDS

- B. Reductions from the minimum required parking spaces from the Zoning Code may be approved as part of a Mixed Use (MXD) site plan or Planned Area Development (PAD) that meets the standards of Leadership in Energy and Environmental Design (LEED) criteria specified by the U.S. Green Building Council, or similar rating agency. Reductions shall be calculated using an accredited system for calculating shared parking. Such reduction shall exclude any and all proposed and anticipated parking spaces reserved exclusively for a specific use such as office, residential, retail, etc. Dedicated valet parking spaces, however, may be part of the shared parking reduction. A restrictive covenant shall be required stating that the amount of parking required as a result of the shared parking reduction shall not be reserved exclusively for a specific use.

The number of required spaces may be reduced by any one (1) or more of the following methods, as may be required by the City:

1. Urban Land Institute (ULI) Shared Parking Methodology using the City’s parking code requirements. A ULI Shared Parking Methodology and the assumptions in the calculation must be approved by the City.
2. Shared parking matrix. The shared parking matrix provides the method for calculating shared parking for mixed use buildings and planned area developments.
  - a. Methodology. MXD or PAD projects containing two (2) or more uses shall multiply the amount of required parking for each individual use, as provided within Section 5-1409, by the appropriate percentage listed in the table below for each of the designated time periods. Calculate the resulting sum for each of the six (6) vertical columns within the table below. The minimum parking requirement shall be the highest sum resulting from the calculations.

Use	Weekday			Weekend		
	Day; 8am - 5pm	Evening; 5pm - 12am	Night; 12am - 8am	Day; 8am - 5pm	Evening; 5pm - 12am	Night; 12am - 8am
Residential	60%	90%	100%	80%	90%	100%
Office	100%	10%	5%	10%	5%	5%
Retail	70%	90%	5%	100%	70%	5%
Restaurant	50%	100%	10%	75%	100%	10%
Hotel	80%	100%	80%	80%	100%	75%
Entertainment	40%	100%	10%	80%	100%	10%
Other	100%	100%	100%	100%	100%	100%

3. Applicants may provide a parking study completed by a licensed professional engineer, engineering firm or similar, justifying the proposed parking solution as provided below.
  - a. Parking study. A study must be prepared using a professionally appropriate methodology that is approved by the City, detailing land uses in accordance with Institute of Transportation Engineers (ITE) parking generation categories. At a minimum, the methodology must incorporate all of the following considerations, as well as any other data or analyses that the City deems appropriate for the requested reduction:
    - i. Parking characteristics of similar projects and uses. The study must evaluate factors such as the uses, hours of operation, peak parking demands, location, amount and type of off-street parking that is proposed, the proposed impact on nearby on-street parking, and occupancy rates of similar uses and projects in comparison to those of the proposed uses and project.
    - ii. Operational assessment. The study must demonstrate how the project will optimize the parking operations and traffic conditions within a quarter (1/4) mile of the project boundaries, and propose and agree to provide appropriate mechanisms to protect the