

Gables Station – Art in Public Places

Gables Station

Proposed Artwork by Blessing Hancock

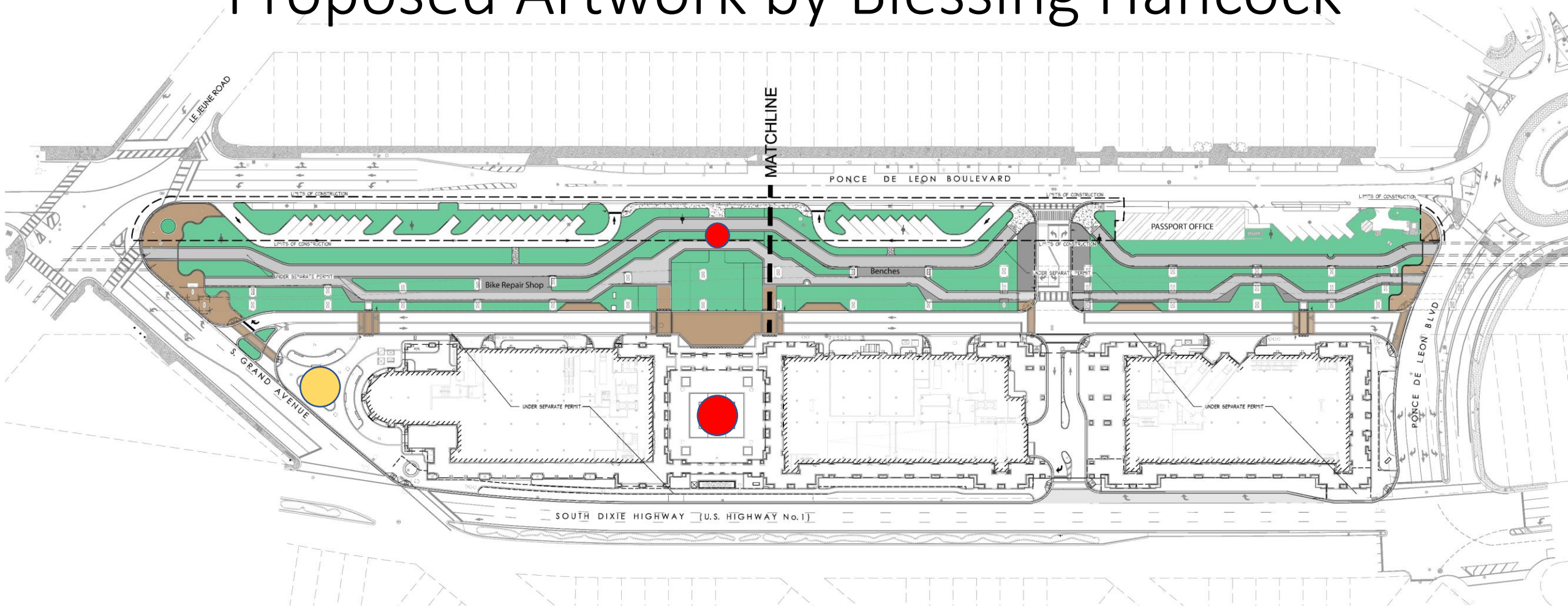

●● Location markers not to scale for presentation clarity

**Blessing Hancock
Artist**







CAUTION!
This workshop is using the Point of View of the Children
to create a safe, fun, and educational experience.
Please do not use sharp objects, scissors, or
tools without adult supervision.



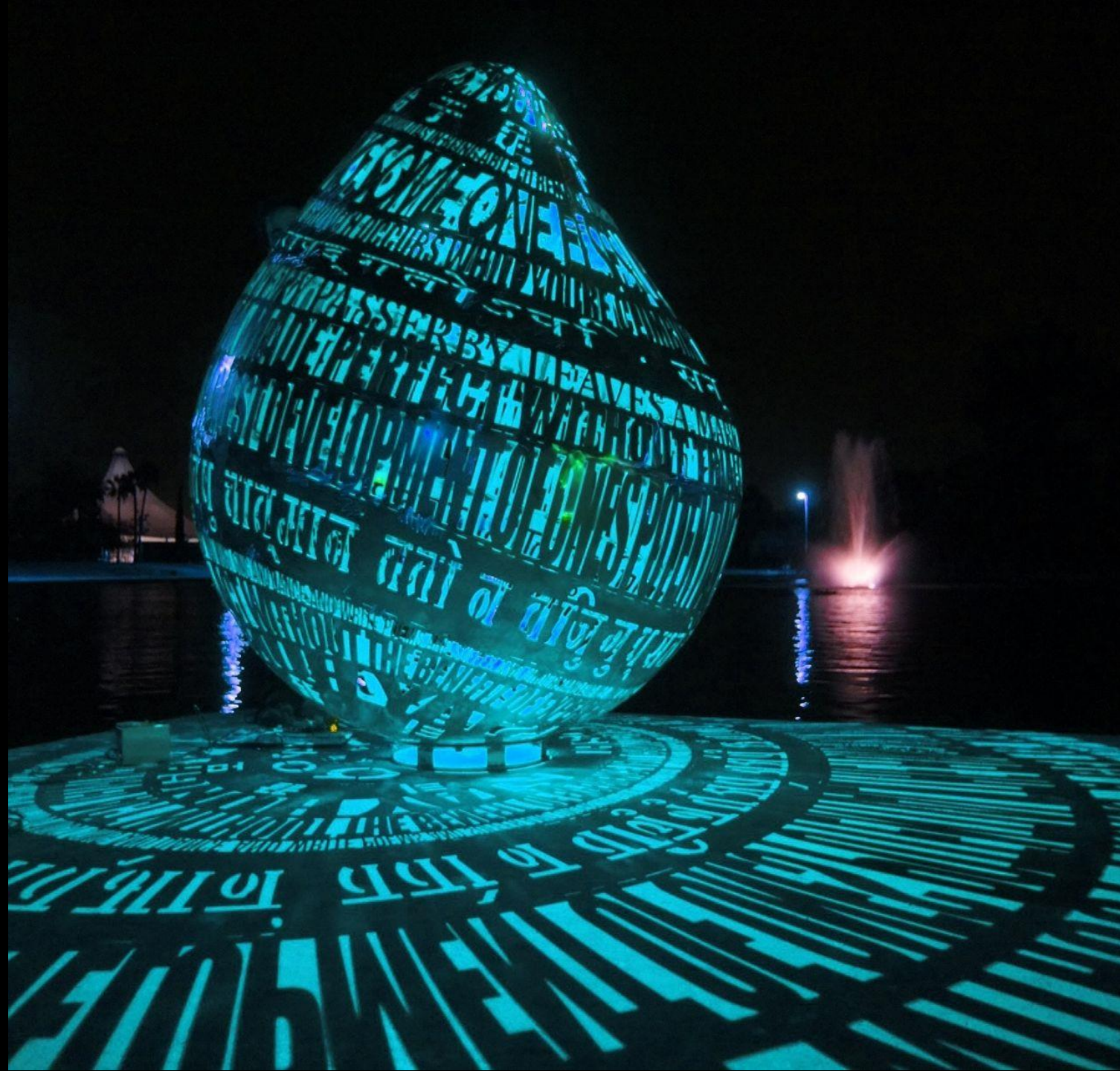





精妙绝伦



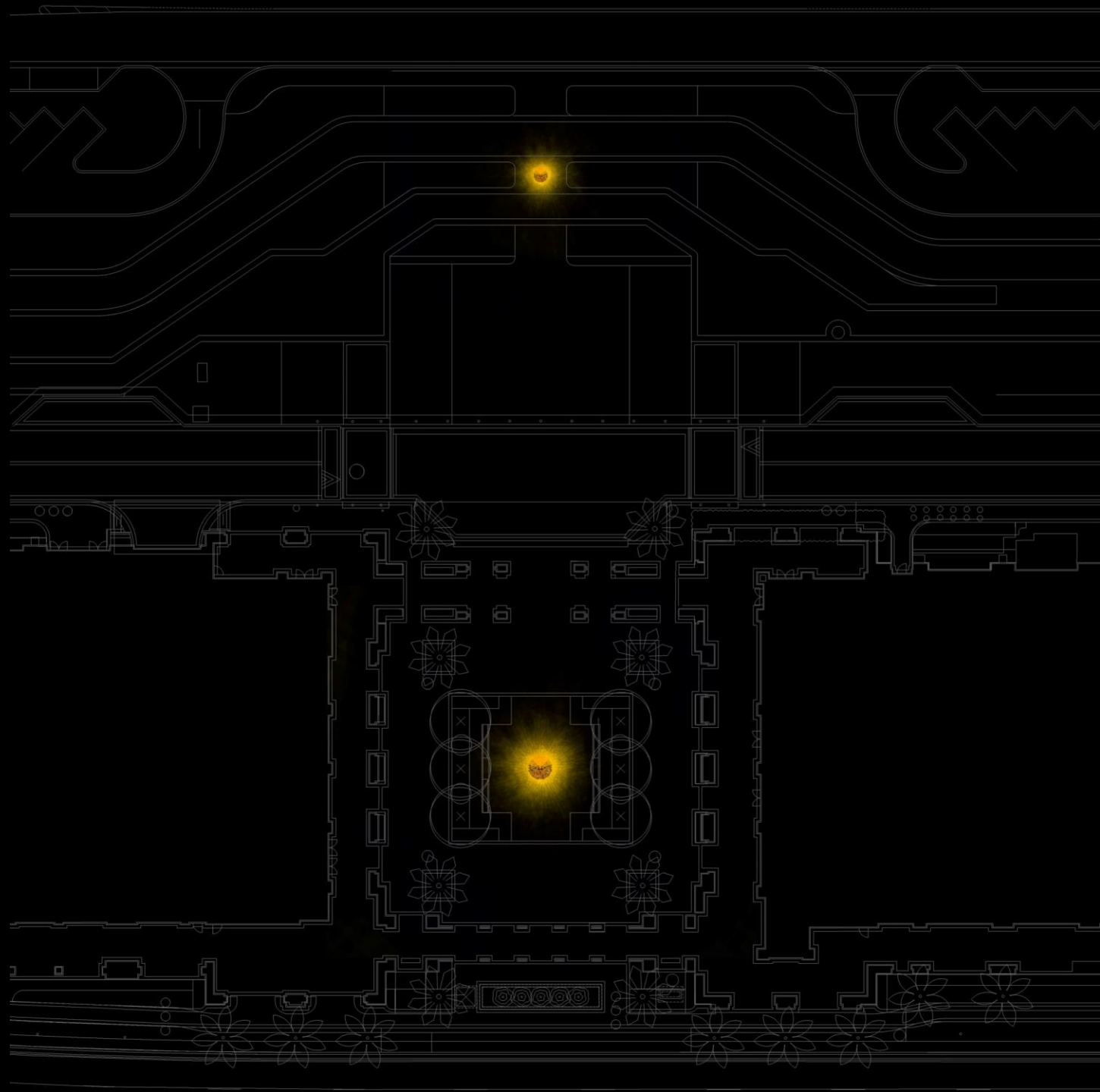

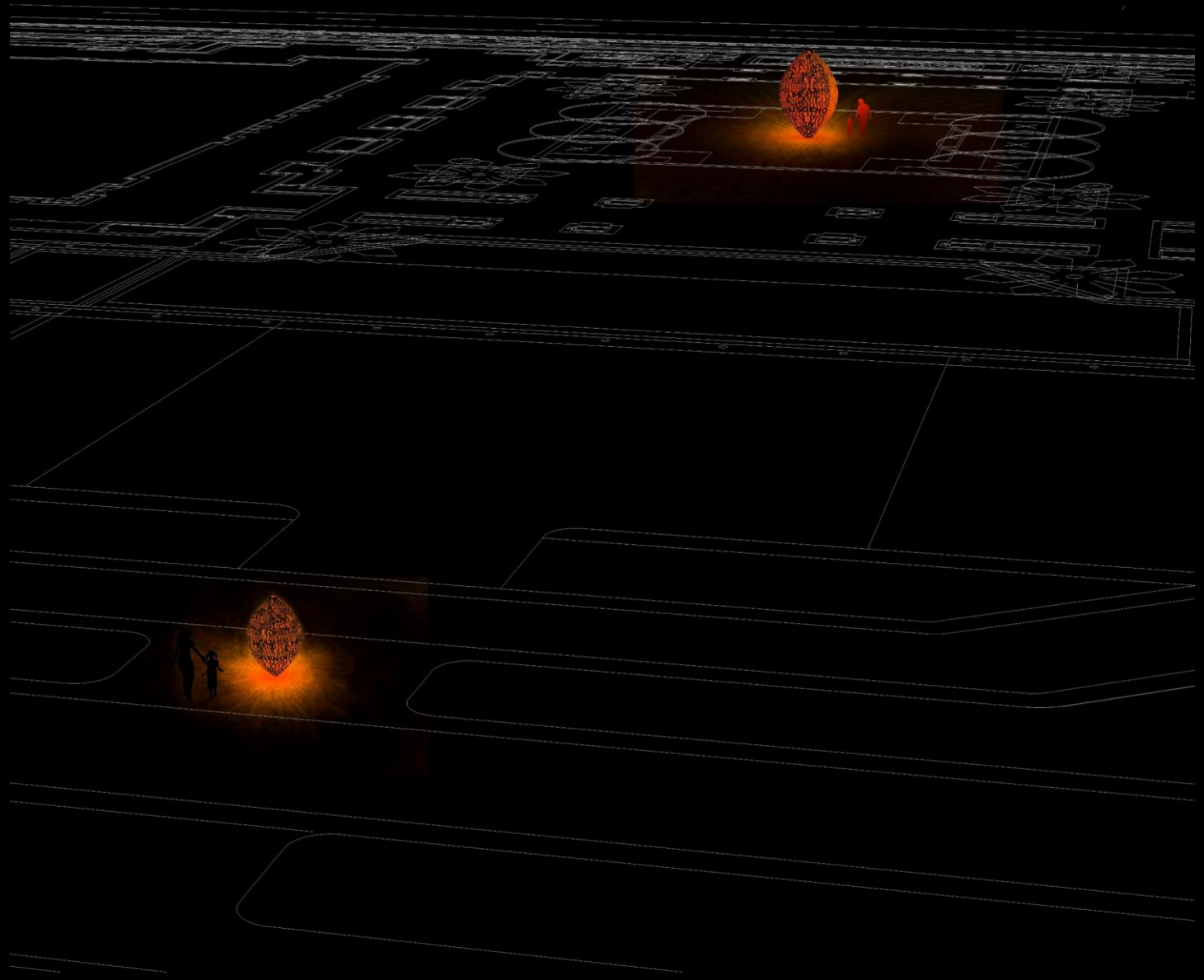

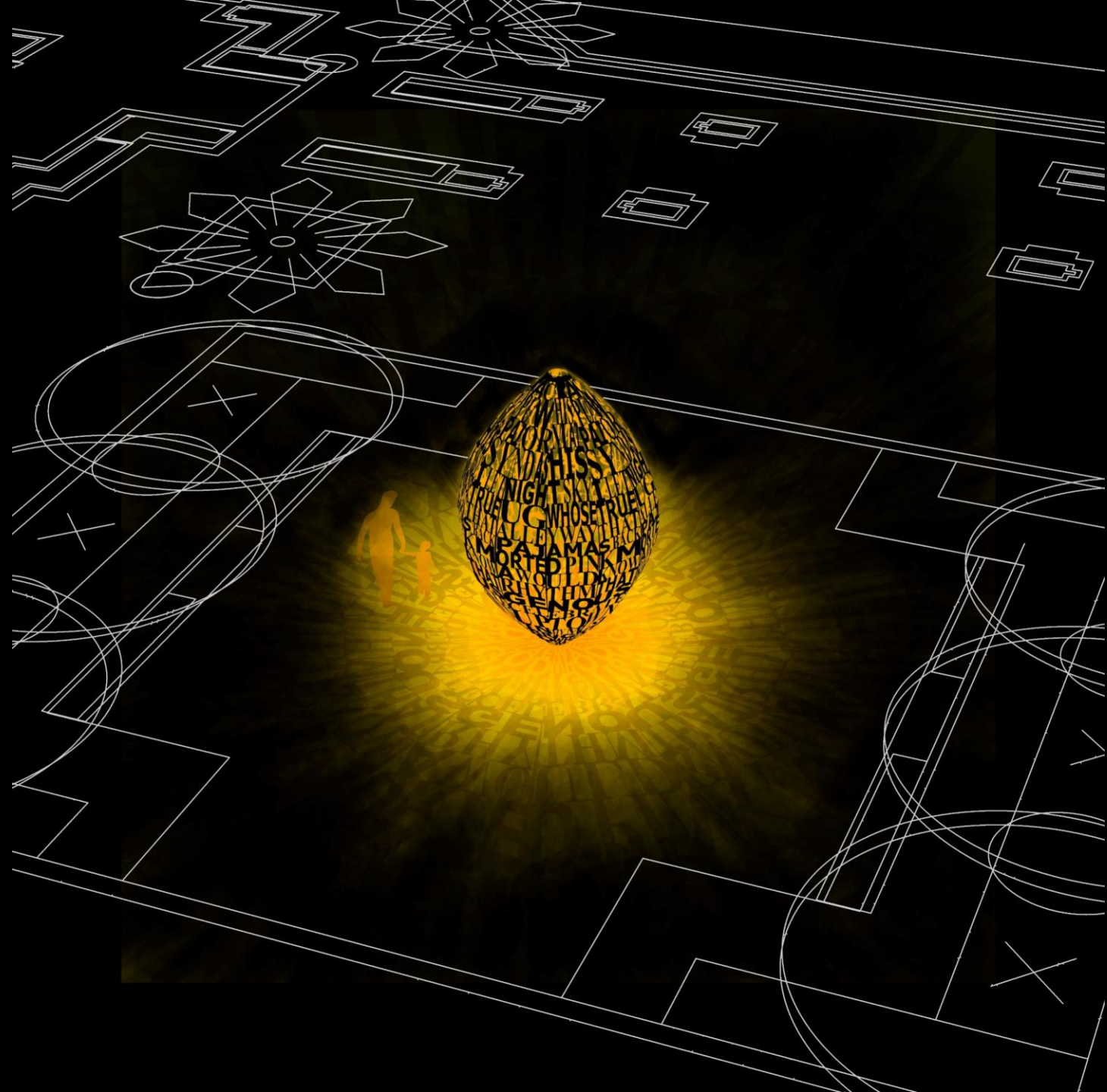





12'h x 8'dia



6'h x 4'dia



**WE INVITE YOU TO PARTICIPATE IN A
NEW PUBLIC ART OPPORTUNITY AT
GABLES STATION**

BY PUBLIC ARTIST: BLESSING HANCOCK

**THE SCULPTURES WILL BE MADE OF WORDS AND PHRASES
COLLECTED FROM THE LOCAL COMMUNITY. THIS GATHERED TEXT
WILL BE CUT OUT OF STEEL AND WELDED TOGETHER INTO
THREE-DIMENSIONAL LANTERN-LIKE FORMS.**

**TAKE THIS OPPORTUNITY TO SHARE YOUR EXPERIENCE, INSPIRE
OTHERS AND LEAVE A LEGACY. ALL ARE WELCOME TO PARTICIPATE.**

**EMAIL YOUR WORDS AND PHRASES TO THE ARTIST AT
BLESSINGHANCOCK@GMAIL.COM**

PARTICIPATION ENDS JULY 15TH, 2018



Leona Ferguson Cooper



Judy Davis



Connie Hamm



Leona Cooper Baker



Edwina Prime



Antoinette Price



Francina Berry



Mosezell Aguilar



Beverly Gibson

Help Contribute to a Gables Station Public Art Project
Artist: Blessing Hancock

Leona
C. Baker

"No one can tell your story better than you can yourself..." -Judy Davis

1. Do you know any stories about how your family first came to MacFarlane Homestead and the Golden Gates?

My family settled in the Golden Gates in 1915.

2. What were some of your first impressions and early experiences in Coral Gables?

① Having to grow up in a segregated society. ② Having to ride/sit on the back of the bus, ③ Use & study from second-hand books.

3. What locations/events/objects best represents your culture within the MacFarlane/Golden Gates communities?

① Names of Parks: (HOLA B. Walker) (William Cooper) (Nettie Moore)
② C.W. Carver School (George Miller Street) ③ St. Mary's Church

4. What cultural traditions or customs have you made an effort to preserve?

① Organized Tea Parties/Oral Interviews/Organized Videos.
② Constructed exhibit boards

5. Are there special family traditions, customs, songs, stories, foods? Favorite Hymns:

① Family sing-a-longs/Listening to stories about the Bahamas.
② Enjoying eating: stewed conch, Peas & Rice, guava duff, coconut tart.
③ Enjoyed attending church: (Episcopal-Anglican)
④ "God is working out his purpose" (with "out" written below)

6. How are you or your family members involved in the MacFarlane/Golden Gates communities?

① Attended community meetings ② Served on committees that acquired historic designations for C.W. Carver and the MacFarlane District

7. What are some of your childhood memories? What games did you play when you were a child?

① Gathering at various homes for story-telling.
② Played (Kick-ball) (hop-scotch) (jumping-jacks)

8. What does the MacFarlane/Golden Gates area mean to you? How do you use it? How has it changed over the years?

It means the two areas should never be forgotten because many of us who were born here chose to remain, and not move away.

9. What specific considerations should the artist keep in mind when incorporating your story into this artwork?

Should consider the "old" houses, tropical trees, Parks & markers.

10. Is there anything else you would like others to know about your story? Although some progress has been made (race-relation) the journey still continues!



(5)

George Washington Carver Elementary Junior, and Senior High was very "near" and "dear" to our hearts.

In 1925, George Merrick offered the board of education five of land so that the then located school on Lejeune Road could be moved to Grand Avenue and Lincoln Drive. A newly designed Spanish building with nine rooms was constructed. It was then known as Dade County Training School.

After several other persons served as principals, the "longtime" and best known principal was Mrs. Frances S. Tucker who came to us from Tuskegee Institute in 1929.

Beginning in 1934, one high school class was added each year until the first senior class graduated in 1939.

In 1943, she led the movement for the school to be named George Washington Carver.

She retired in 1960, and a school is named for her which is located on Douglas Road in Coconut Grove.

Contribute Words and Phrases

Select text will be incorporated into the artwork

Please list your words or phrases relating to the themes of ART, HISTORY, and COMMUNITY

Historic Black African
Community Black Coral
Gables

You are also welcome to email your ideas directly to the artist at blessinghancock@gmail.com
All contributions will remain anonymous.

Contribute Words and Phrases

Select text will be incorporated into the artwork

Please list your words or phrases relating to the themes of ART, HISTORY, and COMMUNITY

Inclusive
Love
Faith
Historical

You are also welcome to email your ideas directly to the artist at blessinghancock@gmail.com
All contributions will remain anonymous.

Contribute Words and Phrases

Select text will be incorporated into the artwork

Please list your words or phrases relating to the themes of ART, HISTORY, and COMMUNITY

Pioneering
Daring
Cultural
Hopeful

You are also welcome to email your ideas directly to the artist at blessinghancock@gmail.com
All contributions will remain anonymous.

Contribute Words and Phrases

Select text will be incorporated into the artwork

Please list your words or phrases relating to the themes of ART, HISTORY, and COMMUNITY

Family
Faith
Love

You are also welcome to email your ideas directly to the artist at blessinghancock@gmail.com
All contributions will remain anonymous.

Judith: No one can tell your story better than you can yourself. If we don't tell our own story, it won't get told properly. [00:00:08]

George: We're talking about Golden Gates in McFarland.[00:00:13]

Leona H Cooper: I think those of us who are sitting here can hope for, that this little neighborhood, where we live, we're fighting to keep some of the character of the houses. [00:00:27]

Francine: All of us here, we don't consider ourselves strangers, never did, never did. It was always that good connection, that good stuff.[00:00:30]

Moselle: We're about to enter Coral Gables. I'm turning right here on Grand Avenue, and to my right is the Golden Gates, and to my left over here is the McFarland Homestead. [00:01:14]

Leona H Cooper: It was named for a lady who's name was, her last name was McFarland, and she was a good friend of the gentleman that was the one who really put Coral Gables on the map, Merrick. George Merrick. When he bought that land from her to make this and to extend the black area of Coral Gables, they called it the McFarland Homestead. It's now on the National Register of Historic Places, and was the only place in Coral Gables that was on the National Register. My husband and I worked on that for many years, it was difficult to get it done.

Speaker 6: It was first designated as a local historic landmark area in 1989, and it was because the residents themselves came to the Preservation Officer at the time and requested that it be designated, and that's amazing. Then in 1994 it was put on the National Register of Historic Places, which is a big deal. It's the only National Registered District that we have in Coral Gables.

Moselle: It's the diversity of the cultures. I think is what drew everybody here, a lot of them was from Georgia, some of them was from Carolinas, some of them from the Bahamas.

Speaker 7: This is where the Bahamian community lived back in the 1920s, when George Merrick needed people to help him, and he naturally turned to them. They lived in, in what's now McFarland Homestead area, and Golden Gate, and he worked alongside them for nine years as a manual laborer. They helped him build a city, they use their skills in cutting coral and working with local materials, knowing how to orient the houses to the climate because they lived here and knew which way the winds would come from. We didn't have air conditioning in those days, he built homes that fit the environment, and he used the local materials. He was forever grateful to the Bahamian Community for helping him realize his dream.

Edwina: A lot of the areas looked like parts of the Bahamas, and of course this is the area where the Bahamians settled, when they first came to work for George Merrick.

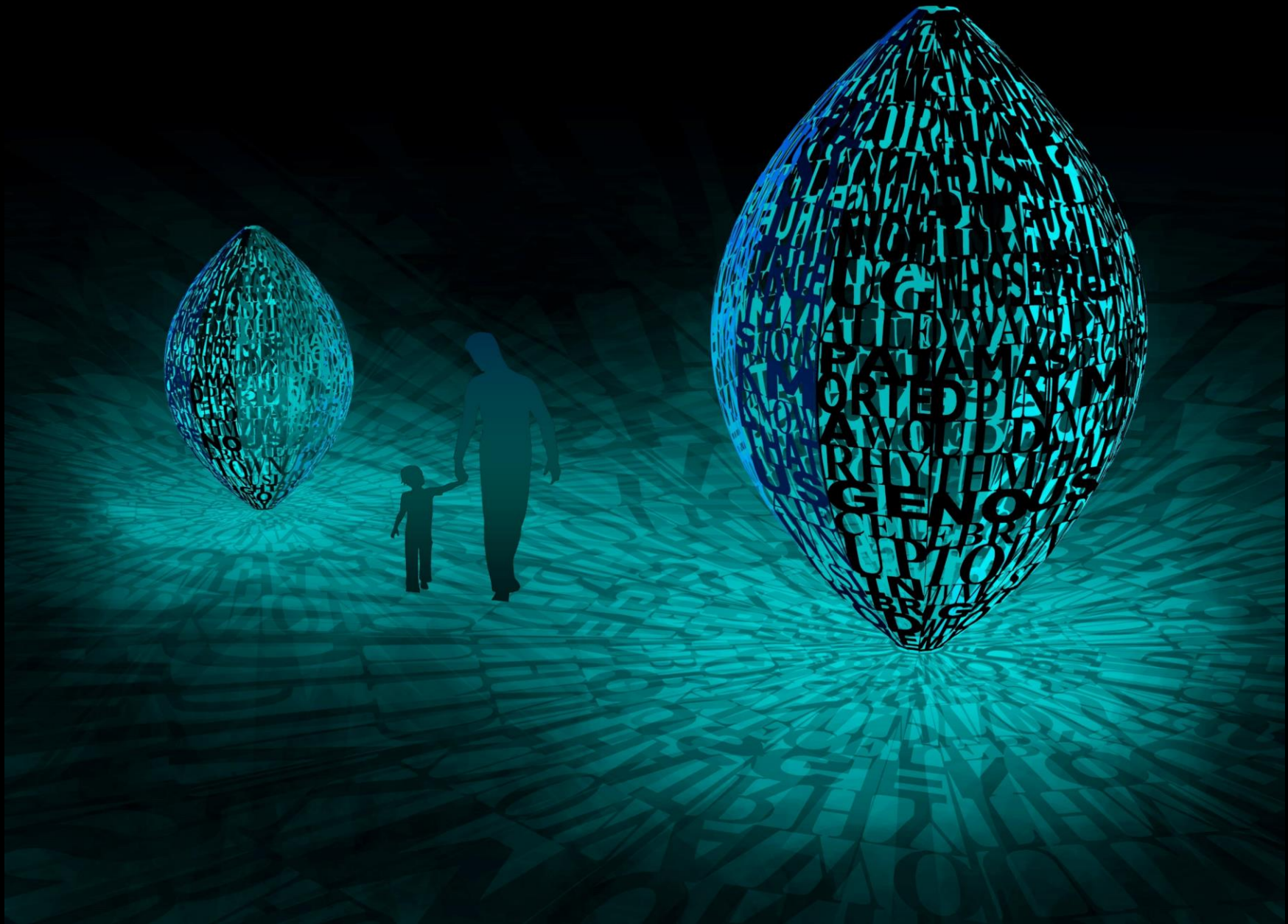

**Blessing Hancock
Artist**



Gables Station

Proposed Artwork by Arturo Berned

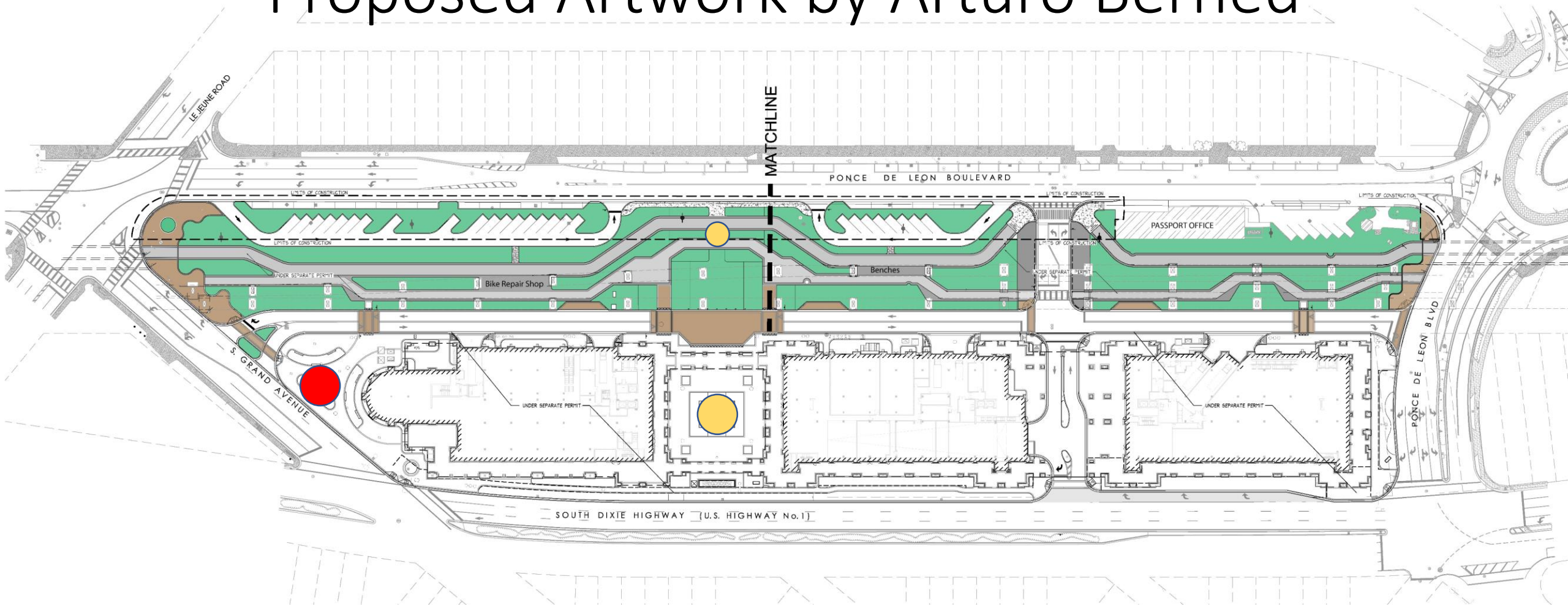

●● Location markers not to scale for presentation clarity

About the Artist



Arturo Berned (Madrid, Spain, 1966) is an architect and sculptor whose work is based upon the reinterpretation of both shapes and metal. Berned conceives sculptures in varying sizes but it is the monumental or urban format that best defines his work, perhaps influenced by this training as an architect and urban planner. The material that he usually uses is steel (Corten, stainless, lacquered).

Berned's work is included in the collections of: The Mori Museum, Mitsui Collection, Ivam Museum, Christian Dior Collection, BMW Collection, Gestamp Collection, Group Collection Caser, Iberdrola Collection, The Soller Museum, Palma De Mallorca, Loewe Foundation, Maraya Foundation, the Ministry of Economy and Finance, and UNESID Union of Steel Companies.

Artist: Arturo Berned

Title: Cabeza “TBD”

Year: 2018 - 2019

Dimensions: Tbd

Weight: Tbd

Suggested Materials: Corten Steel Plate, 5mm thick oxidized finish

Description: Purchased artwork by Arturo Berned at Gables Station will stand at US 1 and Grand Avenue as the gateway landmark. Berned conceives of the sculptures from mathematical laws and geometric forms, and employs a high technical precision and a very purified production. The result is a conceptually abstract work created based on the golden ratio (also known as gold number, or phi number).

Artwork Example, *Head IX* *Continued*

in suggested style and finish

HEAD IX

144c226

2013

CORTEN STEEL PLATE 5 MM THICK

OXIDISED FINISH

H 89,0 x L 118,5 x W 88,2 "

2.139 LB

PRIVATE COLLECTION

MINNEAPOLIS, MINNESOTA, USA

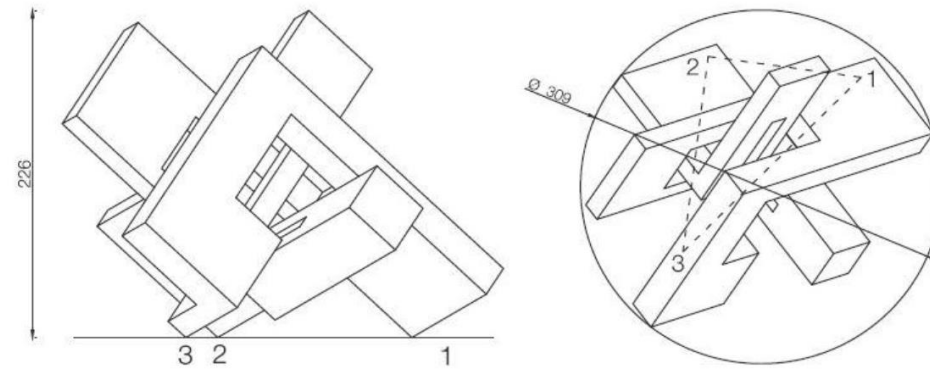



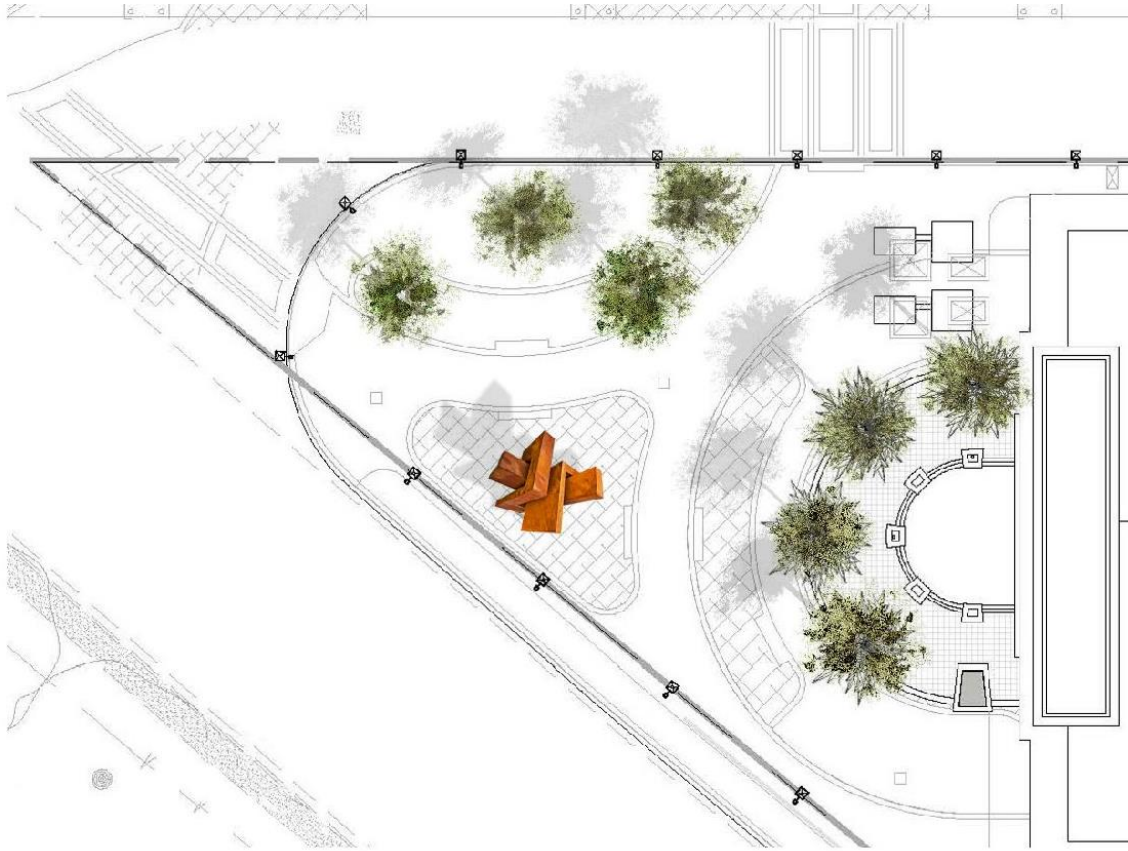

BURNET
FINE ART & ADVISORY

*Note: Accentuating landscaping and lighting TBD
Overhead perspective not to scale

146.85 inches

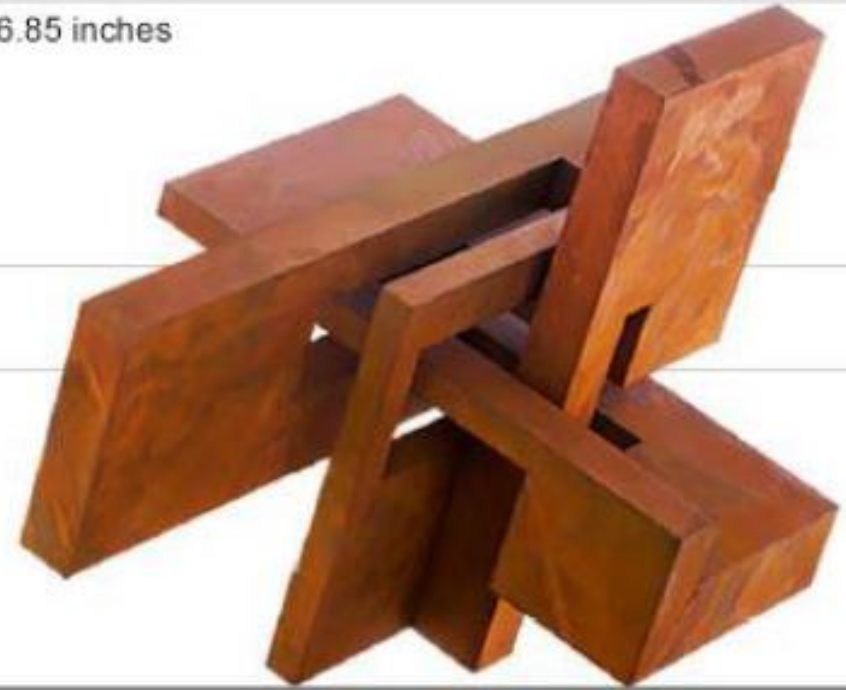

CABEZA XVII
3.73 MTS
(146.85 IN)

Gables Station

Proposed Artwork by Arturo Berned

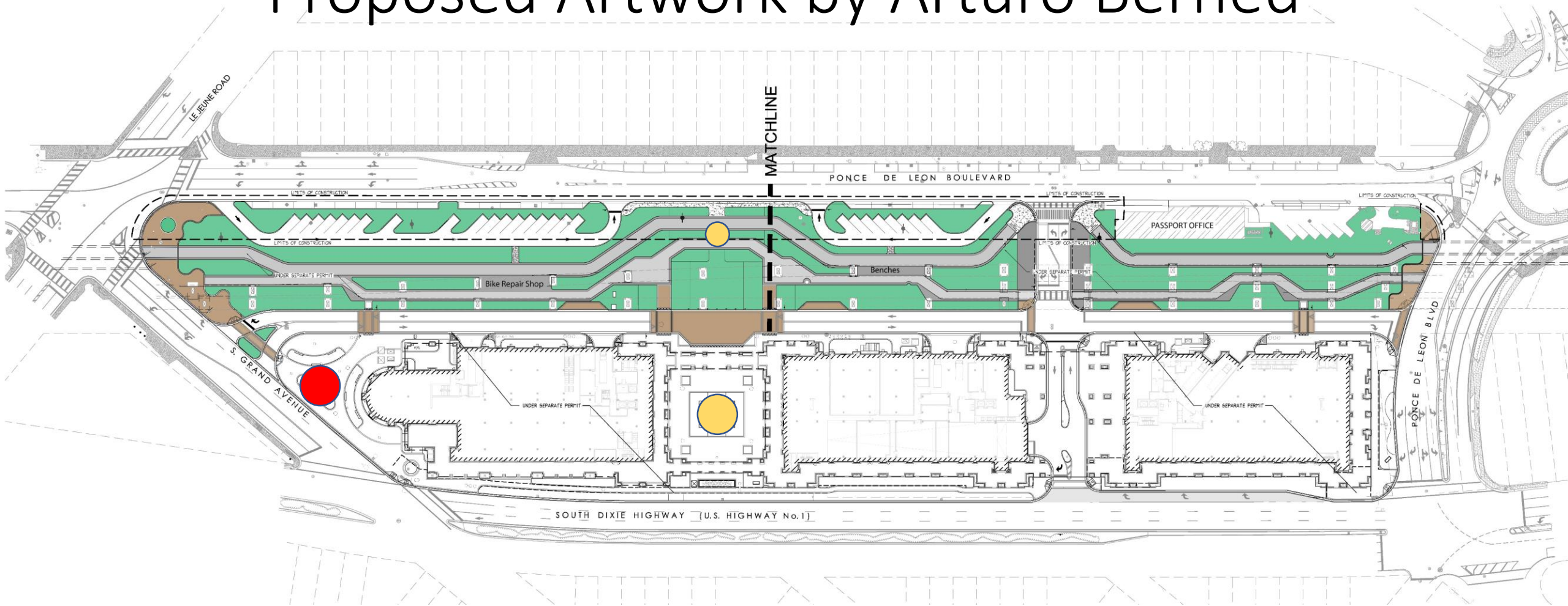

●● Location markers not to scale for presentation clarity

Paseo de la Riviera – Art in Public Places

Paseo de la Riviera

Proposed Artwork: "Storm" by Jaume Plensa



● Location marker not to scale for presentation clarity

Artwork Specifications

Artist: Jaume Plensa

Title: *Storm*

Year: 2013

Dimensions: 87 x 58 x 108 1/4 in (221 x 147 x 275 cm)

Weight: Approx. 900 pounds

Materials: Stainless steel

Description: Storm would be located at Paseo, which is punctuated by a large, open-air plaza. The artwork will be located at the entrance of the plaza along US-1 frontage to serve as a focal point for the project and enhance the sense of place within the plaza. Jaume Plensa, “an acclaimed creator of public art,” creates sculptures and installations that unify individuals through connections of spirituality, the body, and collective memory. Literature, psychology, biology, language, and history have been key guiding elements throughout his career. Using a wide range of materials including steel, cast iron, resin, paraffin wax, glass, light, water, and sound, Plensa lends physical weight and volume to components of the human condition and the ephemeral.

About the Artist



Jaume Plensa (b. 1955, Barcelona, Spain) is highly active in projects in public space; his celebrated and sought after works can be seen in Millennium Park, Illinois; Olympic Sculpture Park, Washington; Burj Khalifa, United Arab Emirates; BBC Broadcasting Tower and St. Helens, England; Pearson International Airport, Canada; Daikanyama, Toranomon Hills, and Ogijima Japan; Shanghai IFC Mall, China; Albright Knox Art Gallery, New York; Rice University, Texas; Bastion Saint-Jaume, France; Raoul Wallenberg Square, Sweden; and Pérez Art Museum Miami, Florida, among many other sites worldwide.

The artist has presented solo exhibitions at prestigious institutions around the globe including the Institut Valencia d'Art Moderne, Spain; Nasher Sculpture Center, Dallas, Texas; Musée Picasso, France; Yorkshire Sculpture Park, England; and the Espoo Museum of Modern Art, Finland. Jaume Plensa: Human Landscape recently to the Cheekwood Botanical Garden & Museum of Art, Tennessee; Tampa Museum of Art, Florida; and Toledo Museum of Art, Ohio. Jaume Plensa: Together was presented at the Basilica San Giorgio Maggiore in Italy as a collateral event of the 56th Venice Biennale.



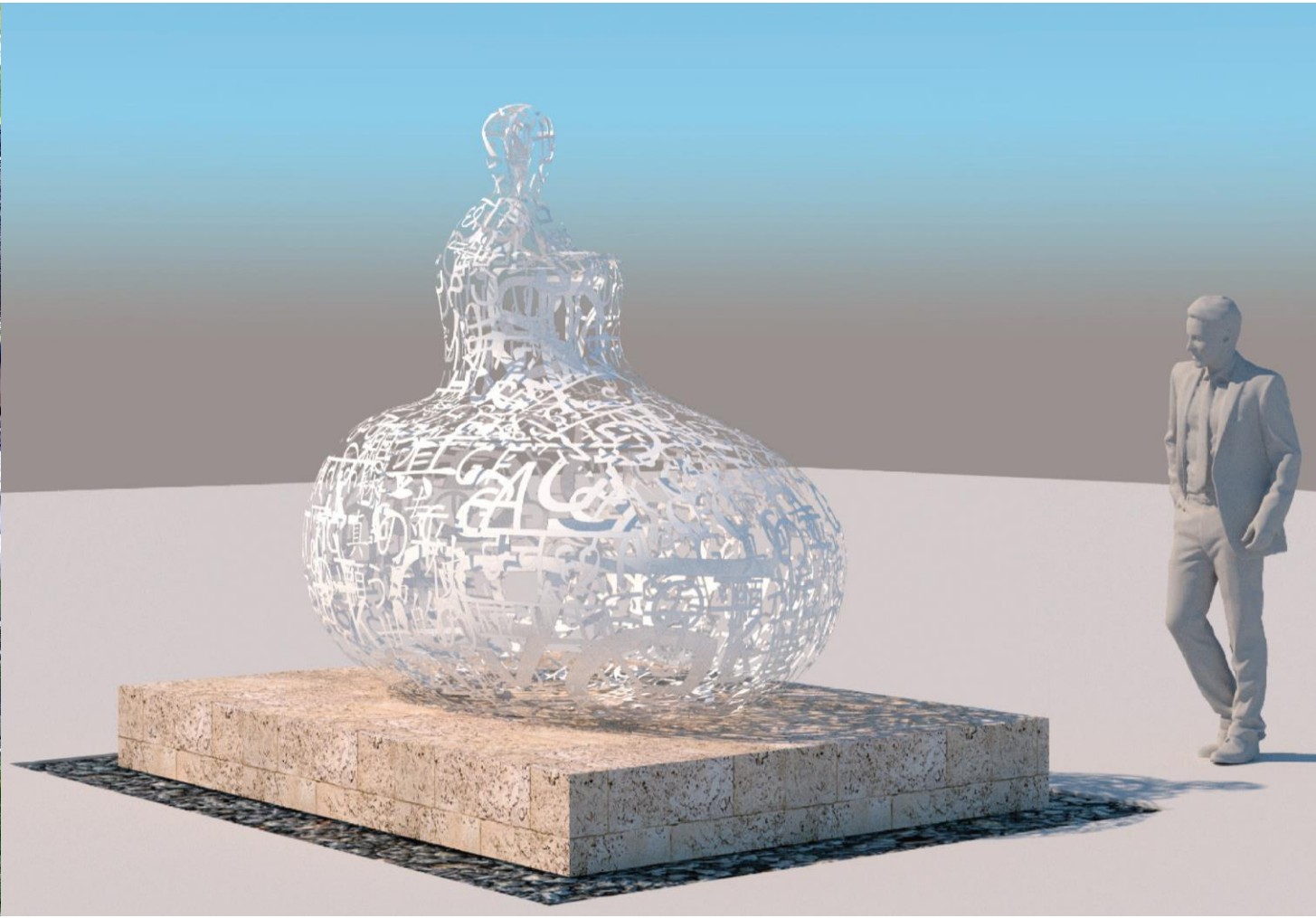

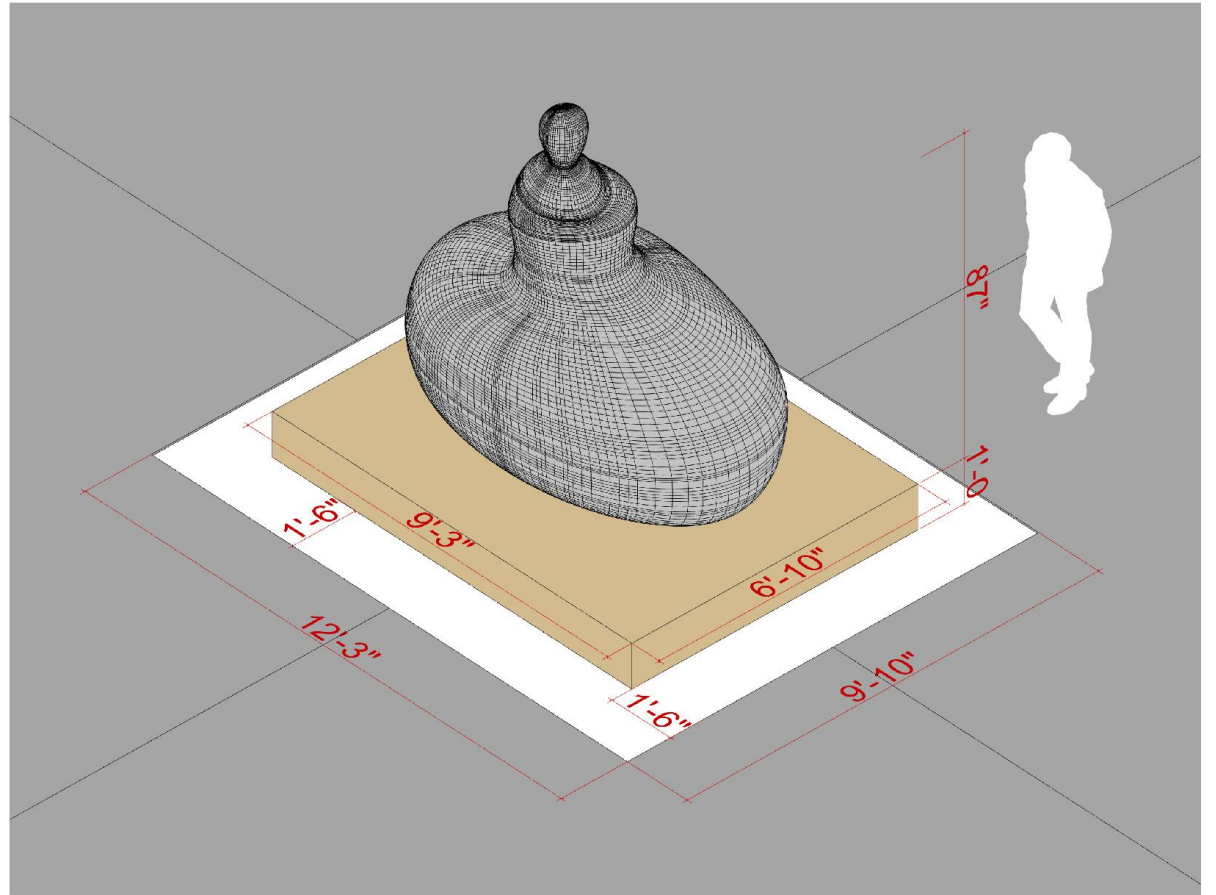
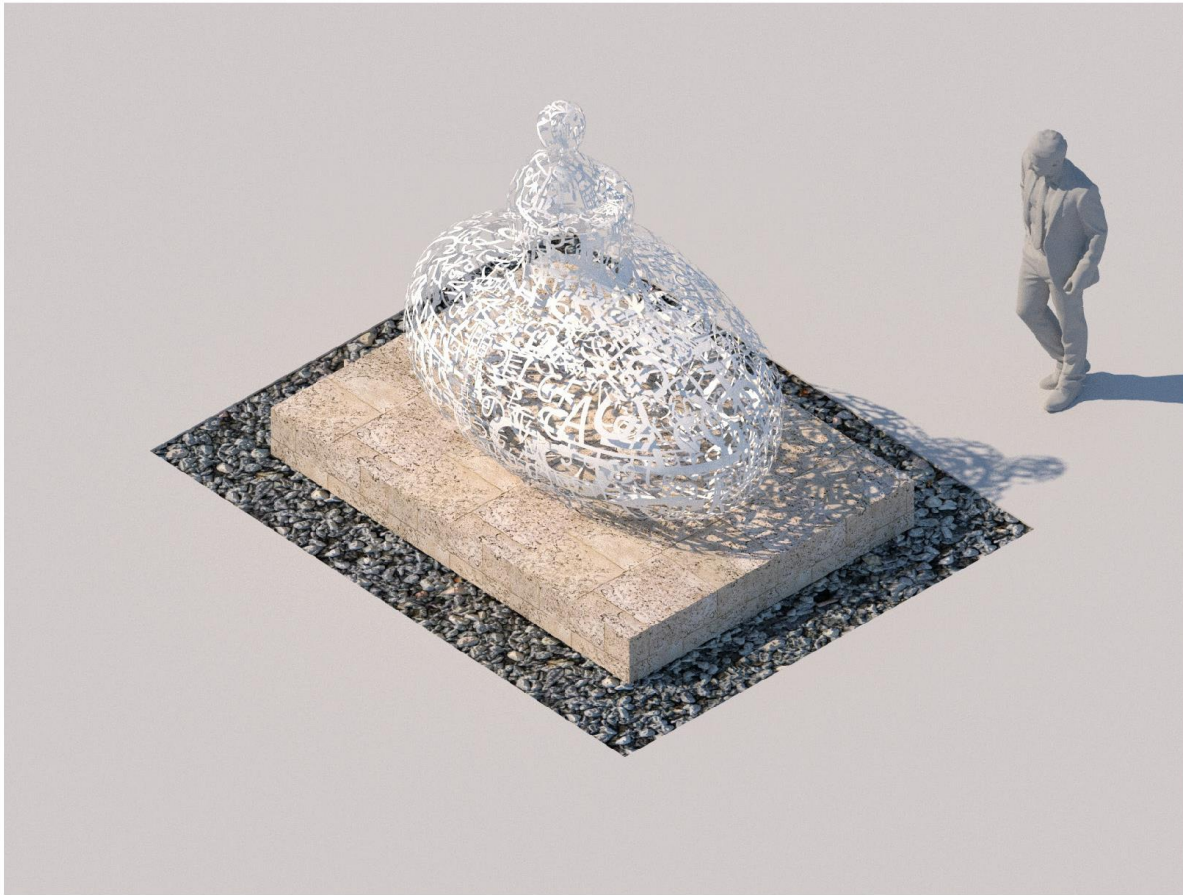

3'-6" REACH FROM EDGE OF RIVER STONE
TO SCULPTURE ON ALL SIDES

Paseo de la Riviera

Proposed Artwork: "Storm" by Jaume Plensa



● Location marker not to scale for presentation clarity

● : Artwork Location

